

QUICKSILVER[®]
Marine Parts & Accessories

2019

Parts Guide



EUROPE, MIDDLE EAST and AFRICA EDITION



TABLE OF CONTENTS

Introduction	c
Mercury® Outboards	2
Mercury® MerCruiser®	149
Competitor Parts	248
Part Number to Page Number Reference	253
Part Description Index	268

HOW TO USE YOUR PARTS AND ACCESSORIES GUIDE

Part and Packaging Information

Packaging and Unit Pricing

There are three different units of packaging for parts and accessories, they are:

1. Individually — Items that do not indicate any package quantity are priced and sold individually.
2. Priced individually, sold in specified quantity — When part numbers show the "@" sign, order the quantity you require. Orders will be rounded up to the next quantity.
3. Priced and packaged in quantities of a specified number — The items are sold in a specified case or package quantity. The quantities ordered should reflect the number of cases or packages you would like to purchase.

Part Classification

Part classification codes help to quickly identify a parts category. The following parts classification chart identify the part category use.

Part Classification Codes		
5 — Stern drives	39 — Piston rings	90 — Printed and advertising material
6 — Transom/gimbal housing	40 — Lock rings (piston pin)	91 — Tools and equipment
10 — Screws and bolts	41 — Piston pins	92 — Paint and lubricants
11 — Nuts	42 — Muffler	93 — Miscellaneous parts
12 — Washers (plain)	43 — Gears	97 — Anodes
13 — Washers (lock and wave)	44 — Propeller shafts	98 — Kits
14 — Washers (tab)	45 — Drive shafts	100 — Cowls and starter housings
15 — Shims	46 — Water pump cartridges	200 — Flywheels
16 — Studs	47 — Impellers	300 — Ignition components
17 — Pins and rivets	48 — Propellers	400 — Crankshafts
18 — Cotter pins	50 — Starters	500 — Center main bearings
19 — Welch plugs	51 — Cylinder liner	600 — Connecting rods
20 — Valves (shut-off)	52 — Clutches	700 — Pistons
21 — Check valves	53 — Rings (snap, "E", retaining)	800 — Cylinder blocks
22 — Fittings	54 — Clips and clamps	900 — Crankcases
23 — Bushings and spacers	55 — Shock absorbers	1000 — Cylinder block covers
24 — Springs	57 — V-belts	1100 — End caps and bearing housings
25 — O-rings and grommets	61 — Powerheads	1200 — Fuel tanks
26 — Seals	62 — Inflatable boat parts	1300 — Carburetors and components
27 — Gaskets	64 — Throttle, shift and steering	1400 — Clamps and swivel brackets
28 — Keys	67 — Boating accessories	1500 — Driveshaft housings
29 — Needle bearings	68 — Inflatable boat parts	1600 — Gear housings
30 — Ball bearings	79 — Instrument gauges	2100 — Cowls and starter housings
31 — Roller bearings	82 — Potentiometer	2400 — Cam shaft and crankshaft
32 — Lines (fuel, air, water)	83 — Varistors and rectifiers	2700 — Pistons
33 — Spark plugs	84 — Wiring harness and electrical cables	2800 — Cylinder blocks
34 — Reeds and reed stops	85 — Insulators	3300 — Carburetors and components
35 — Filters and strainers	86 — Connectors, terminals, terminal blocks	3400 — Clamp and swivel braces
36 — Filter caps	87 — Switches	3500 — Driveshaft housing
37 — Decals	88 — Fuses and light bulbs	3600 — Transmission
38 — Serial and name plates	89 — Solenoids	4000 — Cowls

Parts and Accessories Ordering Information

Brunswick Marine in EMEA recommends using Extranet for all product ordering, order status and Dealer account information. For all of your concerns on P&A ordering questions, please call your Customer Service representative.

Mercury Precision, SmartCraft and Quicksilver Parts and Accessories Limited Warranty

What is Covered

Brunswick Marine in EMEA warrants each new or factory rebuilt Mercury Precision, SmartCraft, Quicksilver parts and accessories, and Mercury Racing Propellers sold by a Mercury authorized dealer or distributor, to be free from defects in material and workmanship during the period described following.

Duration of Coverage

This limited warranty provides coverage for one year from either the date on which the product is first sold to a retail customer by a Mercury authorized dealer or distributor, or the date on which the product is first put into service, whichever occurs first.

Parts and accessories installed on Mercury Racing products that have product warranty duration of less than one year, carries a limited warranty coverage for a period of time equal to, and not greater than, the duration of the limited warranty originally provided with the parent product. The repair or replacement of parts, or the performance of service under this warranty, does not extend the life of this warranty beyond its original expiration date. Unexpired warranty coverage can be transferred to a subsequent purchaser upon proper re-registration of the product.

Conditions That Must be Met in Order to Obtain Warranty Coverage

Warranty coverage is available only to retail customers that purchase from a dealer authorized by Brunswick Marine in EMEA to distribute the product in the country in which the sale occurred. Routine maintenance outlined in the Operation and Maintenance Manual must be timely performed in order to maintain warranty coverage. Brunswick Marine in EMEA reserves the right to make warranty coverage contingent upon proof of proper maintenance.

What Mercury Will Do

Mercury's sole and exclusive obligation under this warranty is limited to, at our option, repairing a defective part, replacing such part or parts with new or refunding the purchase price of the Mercury product. Mercury reserves the right to improve or modify products from time to time without assuming an obligation to modify products previously manufactured.

How to Obtain Warranty Coverage

The customer must provide Mercury with a reasonable opportunity to repair, and reasonable access to the product for warranty service. Warranty claims shall be made by delivering the product for inspection to a Mercury dealer authorized to service the product. If the purchaser cannot deliver the product to an authorized dealer, written notice must be given to Brunswick Marine in EMEA. We will then arrange for the inspection and any covered repair. The purchaser shall pay for all related transportation charges and travel time. If the service provided is not covered by this warranty, the purchaser shall pay for all related labor, material, and any other expenses associated with that service. The purchaser shall not, unless requested by Mercury, ship the product or parts of the product directly to Brunswick Marine in EMEA. The original purchase receipt establishes the warranty period and must be presented to the dealer at the time warranty service is requested in order to obtain coverage.

What is Not Covered

This limited warranty does not cover routine maintenance items, tune ups, adjustments, normal wear, damage caused by abuse, abnormal use, double lab finished propellers, use of a propeller or gear ratio that does not allow the engine to run in its recommended wide open throttle RPM range (refer to the Operation and Maintenance Manual), operation of the product in a manner inconsistent with the recommended operation/duty cycle section of the Operation and Maintenance Manual, exceeding the horsepower limitations for the product as listed on the Mercury Racing propeller or in the Quicksilver Precision/Mercury Racing Accessory Guide, neglect, accident, submersion, improper installation (proper installation specifications are explained in the installation instructions for the product), improper service, use of an accessory or part not manufactured or sold by Brunswick Marine in EMEA, jet pump impellers and liners, operation with fuels, oils or lubricants which are not suitable for use with the product (refer to the Operation and Maintenance Manual), alteration or removal of parts, water entering the engine through the fuel intake, air intake or exhaust system, or damage to the product from insufficient cooling water caused by blockage of the cooling system by a foreign body, running the engine out of water, mounting the engine too high on the transom, or running the boat with the engine trimmed out too far. Use of the product for racing or other competitive activity, or operating with a racing type lower unit, at any point, even by a prior owner of the product voids the warranty.

Mercury Precision, SmartCraft and Quicksilver Parts and Accessories that are used for any purpose for which they are not intended (outside anticipated marine applications) are excluded from coverage under this warranty statement. Expenses related to haul-out, launch, towing, storage, telephone, rental, inconvenience, slip fees, insurance coverage, loan payments, loss of time, loss of income, or any other type of incidental or consequential damages are not covered by this warranty. Also, expenses associated with the removal and/or replacement of boat partitions or material caused by boat design for access to the product are not covered by this warranty.

No individual or entity, including Brunswick Marine in EMEA authorized dealers, has been given authority by Brunswick Marine in EMEA to make any affirmation, representation or warranty regarding the product, other than those contained in this limited warranty, and if made, shall not be enforceable against Brunswick Marine in EMEA. For additional information regarding events and circumstances covered by this warranty, and those that are not, see the Warranty Coverage section of the Operation and Maintenance Manual, incorporated by reference into this warranty.

Disclaimers and Limitations

THE IMPLIED WARRANTIES OF MERCHANTABILITY AND FITNESS FOR A PARTICULAR PURPOSE ARE EXPRESSLY DISCLAIMED. TO THE EXTENT THAT THEY CANNOT BE DISCLAIMED, THE IMPLIED WARRANTIES ARE LIMITED IN DURATION TO THE LIFE OF THE EXPRESS WARRANTY. INCIDENTAL AND CONSEQUENTIAL DAMAGES ARE EXCLUDED FROM COVERAGE UNDER THIS WARRANTY. SOME COUNTRIES DO NOT ALLOW FOR THE DISCLAIMERS, LIMITATIONS AND EXCLUSIONS IDENTIFIED ABOVE, AS A RESULT, THEY MAY NOT APPLY TO YOU. THIS WARRANTY GIVES YOU SPECIFIC LEGAL RIGHTS, AND YOU MAY ALSO HAVE OTHER LEGAL RIGHTS WHICH VARY FROM COUNTRY TO COUNTRY.

ExtraNET

ExtraNET is Brunswick Marines exclusive on-line system that will provide you access to the tools that will make your business efficient and profitable. Our electronic systems are intended to meet the needs of your business, large or small. The system allows you to perform functions faster and more accurately, enter orders, access product and warranty information more efficiently and much more. ExtraNET customers enjoy extra benefits, such as:

- Create orders for parts & accessories, certain finished products like outboards, inflatable boats, etc.
- Browse product configurator
- Check part and product availability
- View product history by serial number
- View order status and print invoices, statements and age analysis
- File product registration and consult pipeline
- File warranty claims
- Parts and products ordering 7 days a week
- File product protection plans

All ExtraNET systems are subject to change, as we continue to improve our products based on customer input.

New Electronic Parts Catalog

The New Electronic Parts Catalog (EPC) containing the Mercury Parts Catalogs and Service Bulletins is available for ExtraNET customers on a USB memory stick (P/N 8M0118036) for offline usage and via a link on the ExtraNET for online usage.

Features of the Electronic Parts Catalog include:

- Improved look and feel with easier navigation
- Enhanced search functionality • Key word search • Part number search • Document search • Multiple searches open at the same time
- Mobile-friendly interfaces for portable devices, with real-time updates – no need to worry about running updates in the online version!
- Convenient "hot spots" to find part numbers on schematics faster
- Multi-language translation
- Track your activity and to-do projects with personal notes
- Daily pricing update for the online version and weekly pricing update for the offline version

Recommended System Requirements Electronic Parts Catalog

- Microsoft Windows 7 or Newer Operating System
- 550 MHz or faster processor
- 512 MB RAM or greater
- 12 GB of free hard disk space (if installing the EPC on a hard drive)
- USB Drive
- High Speed Internet access
- Internet Explorer 10.0 or greater
- Color monitor (resolution 1024 x 768 pixels)
- Local Printer

Extranet Customer Service Contact Information

Please contact your customer representative or your Mercury/Mariner distributor representative.

TABLE OF CONTENTS

Ignition	2	Cooling System	92
Brushes	10	Outboard Thermostats & Temperature Sender	116
CDM Assemblies	9	Outboard Water Impeller Repair Kits - Early Mariner	101
Condenser	2	Outboard Water Impeller Repair Kits - Mercury/Mariner	99
Distributor Caps	10	Outboard Water Pump Impeller - Early Mariner	98
Ignition Charts - 2-Cycle Standard Components	13	Outboard Water Pump Impeller - Force	97
Ignition Charts - FourStroke Standard Components	10	Outboard Water Pump Impeller - Mercury/Mariner	95
Ignition Coil	2	Outboard Water Pump Kits - Complete	92
Points	2	Outboard Water Pump Upper Housings	103
Rotors	10	Outboard Water Pump Upper Repair Kits	94
Switchbox	7	Water Pump Repair Charts	105
Electrical System	23	Rewind Starter	119
Battery Cables	23	Starter Rope and Recoil Spring Charts	119
Electrical Harness Repair Components	58	Powerhead Components	121
Electrical Harness Seal Kit	61	Gasket Set Application Charts - Powerhead	130
Rectifier	23	Gasket Sets - Mercury/Mariner Powerhead	121
Relays - Power Trim	46	Head Gaskets	128
Solenoid and Relay Chart - Mercury/Mariner	48	Head Sealing O-Rings	127
Solenoids - Starter & Power Trim	45	Hose Clamp Kit	121
Starter Motors & Component Parts	38	Gear Case Components	138
Starter Motors and Components Charts	43	Front Water Inlet Plug Kits	139
Stator	24	Lower Unit Seal Kit Application Charts	142
Stator Application Chart - Mercury/Mariner	30	Lower Unit Seal Kits	139
Voltage Regulators	23	Point of Sale Drain Screws and Seals	138
Fuel System	63		
Carburetor Diaphragm Kits	80		
Carburetor Gaskets & Gasket Kits	72		
Carburetor Repair Charts	85		
Carburetor Repair Kits - Early Mariner	79		
Carburetor Repair Kits - Mercury/Mariner	76		
Check Valve Kits	63		
Floats	83		
Fuel Pump Diaphragm Kits	64		
Inlet Needle Assemblies	81		
Mechanical Fuel Pump Repair Chart	66		

IGNITION

IGNITION

POINTS

POINTS



336- 4318A 2

Points
4-4.5 horsepower 1 cylinder 2 stroke engine. 5595532 & Up

POINTS



F12044

Breaker Point

CONDENSER

CONDENSER



394- 1130A 1

Condenser

CONDENSER



811598

2.5/3 Horsepower 2 stroke engine, 0A855097 thru 0G710612

IGNITION COIL

IGNITION COIL



398- 173

IGNITION COIL

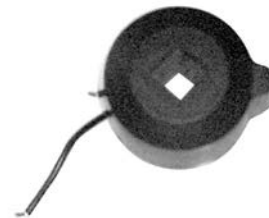

398- 2568T 1

Ignition Coil

IGNITION COIL

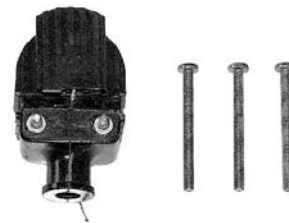

336- 4409A 4

Ignition Coil

IGNITION COIL

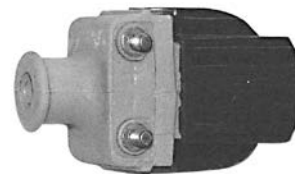

336- 4528T 2

Ignition Coil

IGNITION COIL

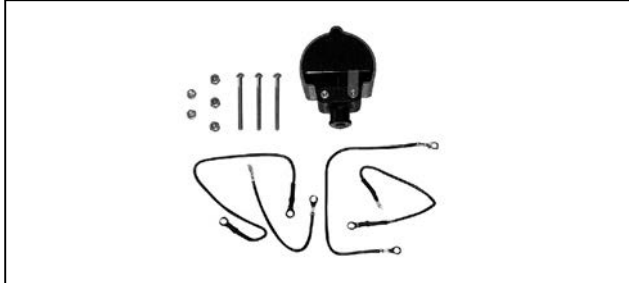

332- 4895A 5

Ignition Coil Kit

IGNITION COIL



332- 4895T 2

Ignition Coil

IGNITION COIL



339- 5288T 2

Ignition Coil

IGNITION COIL



16064006

Ignition Coil

IGNITION COIL



339- 803559A02

8/9.9 Horsepower 4 stroke engine, (USA 0R042475 & Up, Bel 0P325500 & Up)

IGNITION COIL



339- 803559T 1

IGNITION COIL

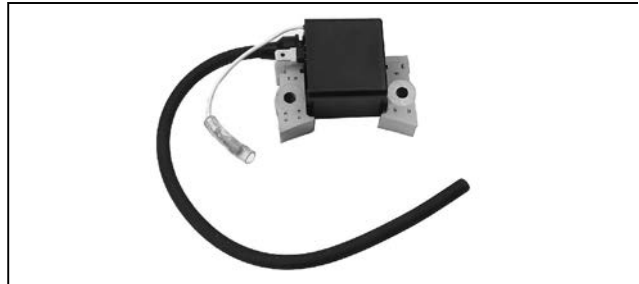

339- 803559T07

4/5/6 Horsepower 4 Stroke (USA 0R067090 thru 0R411837, BEL 0P401000 thru 0R411837)

IGNITION COIL



803559T08

2.5/3.5 hp. FourStroke outboards beginning with s/n 0R318096 & above.

IGNITION COIL



339-804271T

75/90 Horsepower 4 stroke, (OG960500 thru OT800999)

IGNITION COIL



815113T02

Ignition Coil

IGNITION COIL



823033

2/2.5/3/3.3 Horsepower 2 Stroke (USA OT894577 & Up, BEL OP401000 & Up)

IGNITION COIL



339-825101T

40/50 Horsepower 4 stroke (USA OG760300 thru OT178499, BEL OP017000 thru OP094499)

IGNITION COIL



339-830404T 3

30/40 Horsepower 4 stroke (USA OG760300 thru OT408999, BEL OP01700 thru OP153499)

IGNITION COIL



339-832757A 4

Fits a variety of switchbox driven ADI ignition systems found on 2-cycle outboards. Review the Electronic Parts Catalog for your specific application.

IGNITION COIL



855685T

See application chart

IGNITION COIL



339-856991A 1

See application chart

IGNITION COIL



339-858942T 1

See application chart

IGNITION COIL



339-859738T 1

See application chart

IGNITION COIL



339-877807A 2

See application chart

IGNITION COIL



339-879147T71

Fits the F15/20 FourStroke outboards beginning with serial number JPN, 0R235168 and above.

IGNITION COIL



339-8M0077471

Fits the 75/90/115 (3 cylinder) OptiMax outboard beginning in Model Year 2004, and various V-6 2-cycle outboards. See application chart. Also fits MCM 600SCi.

PENCIL COIL



339-880615T01

See application chart

IGNITION COIL



339-880892001

See application chart

IGNITION COIL



300-8M0123821

115 4 Stroke 0T178500 Thru 1B366822

IGNITION

IGNITION COIL



339-8M0077473

See application chart

IGNITION COIL



339-888309

See application chart

IGNITION COIL



339-898103T

See application chart

IGNITION COIL



898103T58

2.5/3.5 hp. FourStroke outboards, 0R131842-0R318095.

IGNITION COIL



898253T24

Uses External Resistor

Fits MCM 4 cyl., V-6 & V-8 engines with conventional ignition and some outboard applications.

IGNITION COIL



300-8M0044991

Fits the F40/50/60 FourStroke (EFI, 4 cylinder) outboard beginning with serial number CHN 1C104424 and newer. Also fits MCM 4.5L V6.

IGNITION COIL



300-8M0045124

Fits the F40 FourStroke (EFI, 3 cylinder) outboard beginning with serial number CHN 1C104334 and newer.

IGNITION COIL KIT



8M0047313

See application chart

IGNITION COIL

Image not Available.

8M0134472

15/20 EFI FourStroke outboard, 0R833820 and above.
Quicksilver Branded

SWITCHBOX

SWITCH BOX ASSY.

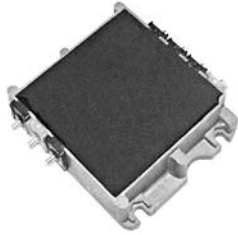

332- 2986A21

See application chart

SWITCH BOX ASSY.



332- 2986A27

For Thunderbolt ignition

SWITCH BOX ASSY.

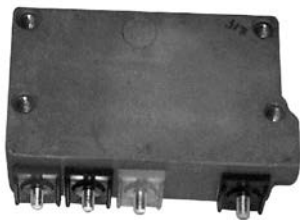

333- 3213A 3

See application chart

SWITCH BOX ASSY.



332- 4911A 2

See application chart

SWITCH BOX ASSY.



332- 4911A 8

See application chart

SWITCH BOX ASSEMBLY



332- 5772A 7

Used on 4 cylinder in-line outboards with ADI ignition systems.
Review the Electronic Parts Catalog for your specific application.

SWITCH BOX ASSY.



339- 6222A 8

See application chart

SWITCH BOX ASSEMBLY



339- 7452A19

Fits a variety of 6-25 Hp. ADI ignition systems found on 2-cycle outboards. Review the Electronic Parts Catalog for your specific application.

SWITCH BOX ASSEMBLY



332- 7778A12

Used on various 3 and 6 cylinder outboards with ADI ignition systems. Review the Electronic Parts Catalog for your specific application.

CDI UNIT



16061T04

See application chart

SWITCH BOX ASSEMBLY



18495A26

Used on various 65 Jet, 75/90 Hp., 3 cylinder outboards with ADI ignition systems. Review the Electronic Parts Catalog for your specific application.

SWITCH BOX ASSEMBLY



19052A 8

Used on various 45/50/55/60 Hp., 3 cylinder outboards with ADI ignition systems. Review the Electronic Parts Catalog for your specific application.

CDI UNIT



803558T02

See application chart

CDI UNIT



804269T 2

See application chart

CDI UNIT



823034T

See application chart

CDI UNIT



835401T 1

See application chart

SWITCH BOX ASSY.



855713A 3

See application chart

SWITCH BOX ASSY.



855713A 4

See application chart

CDI UNIT



835401T06

Fits the F15/20 FourStroke outboards beginning with serial number JPN, 0R235168 and above.

SWITCH BOX ASSY.



899883229

See application chart

CDM ASSEMBLIES

CDM ADAPTER KIT



827509A12

See application chart

CDM MODULE ASSEMBLY



827509T 7

Includes the high tension lead and boot. This CDM is used in a variety of 2-cycle outboards.
Review the Electronic Parts Catalog for your specific application.

CDM MODULE ASSEMBLY



827509A10

Includes the high tension lead and boot. This CDM is used in a variety of 2-cycle outboards.
Review the Electronic Parts Catalog for your specific application.

IGNITION

DISTRIBUTOR CAPS

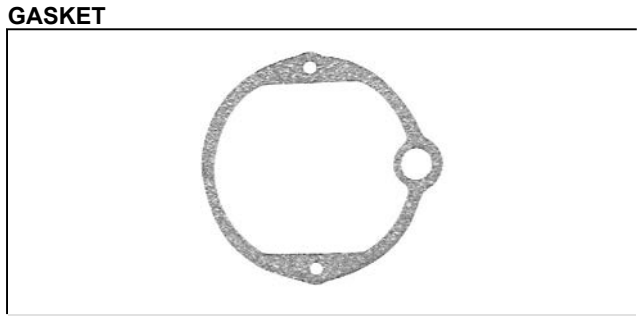

27- 25725
See application chart

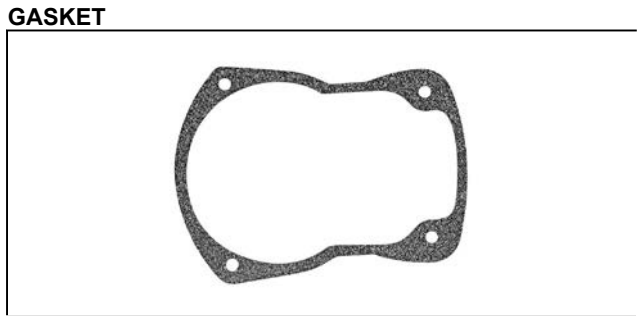

27- 29166
Gasket

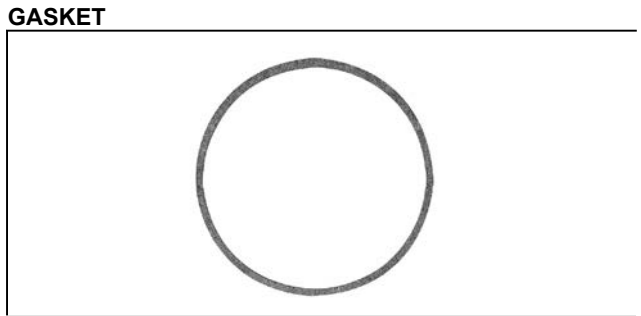

27- 55896
Distributor Cap Gasket
Priced individually, sold @ multiples of 3

ROTORS



393- 1280A 1
See application chart

BRUSHES

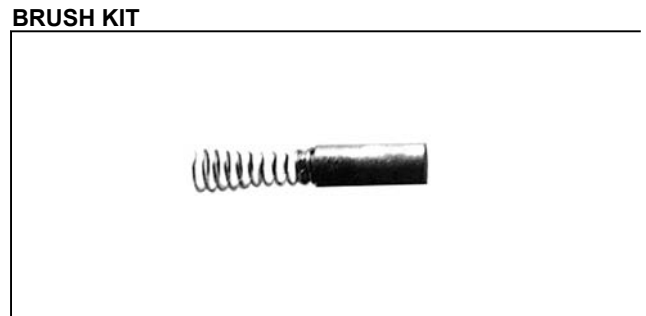

393- 1293A 1
See application chart
Priced individually, sold @ multiples of 2

IGNITION CHARTS - FOURSTROKE STANDARD COMPONENTS

Standard ignition component charts are located within this section. ECM modules and their application chart will be located in a separate section of its own.

FourStroke Ignition Chart

Model	Model Notes	Serial # Range	Ignition Coil	Switch Box or TPM Ass'y
2.5 FourStroke		JPN 0R131842 - 0R318095	898103T58	N/A
2.5 FourStroke		JPN 0R318096 and up	803559T08	N/A
3.5 FourStroke		JPN 0R131842 - 0R318095	898103T58	N/A
3.5 FourStroke		JPN 0R318096 and up	803559T08	N/A
4 FourStroke		JPN 0R000001 - 0R067089	339-803559T 1	803558T02
		BEL 0P073456 - 0P400999		

Model	Model Notes	Serial # Range	Ignition Coil	Switch Box or TPM Ass'y
4 FourStroke		JPN 0R067090 - 0R411837	339-803559T07	N/A
		BEL 0P401000 - 0R411837		
5 FourStroke		JPN 0R000001 - 0R067089	339-803559T 1	803558T02
		BEL 0P073456 - 0P400999		
5 FourStroke		JPN 0R067090 - 0R411837	339-803559T07	N/A
		BEL 0P401000 - 0R411837		
5 FourStroke		JPN 0R411838 and up	8M0056379	N/A
6 FourStroke		JPN 0R000001 - 0R067089	339-803559T 1	803558T02
		BEL 0P073456 - 0P400999		
6 FourStroke		JPN 0R067090 - 0R411837	339-803559T07	N/A
		BEL 0P401000 - 0R411837		
6 FourStroke		JPN 0R411838 and up	8M0056379	N/A
8 FourStroke	Bodensee	USA 0G760300 - 0T178499	N.L.A.	N.L.A.
		USA 0H017100 - 0H017349		
8 FourStroke	323cc	BEL 0P075166 - 0P325499	855685T	835401T 1
8 FourStroke	209cc	USA 0R042475 and up	339-803559A02	835401T02
		BEL 0P325500 and up		
9.9 FourStroke	232cc	USA 0H000058 - 0H016909	N.L.A.	N.L.A.
9.9 FourStroke	323cc	USA 0G760300 - 0T979999	855685T	835401T 1
		BEL 0P075166 - 0P325499		
9.9 FourStroke	209cc	JPN 0R042475 and up	339-803559A02	835401T02
		BEL 0P325500 and up		
15 FourStroke	323cc	USA 0G760300 - 1B727495	855685T	835401T 1
		BEL 0P075166 and up		
15 FourStroke	351cc	JPN 0R235949 - 0R83819	339-879147T71	835401T06
15 EFI FourStroke		JPN 0R833820 and up	8M0134472	
20 FourStroke	351cc	JPN 0R235168 - 0R833819	339-879147T71	835401T06
20 EFI FourStroke		JPN 0R833820 and up	8M0134472	
25 FourStroke	Carb	USA 0G590000 - 1B344298	339-859738T 1	ECM
		BEL 9973100 - 0P388282		
25 FourStroke	EFI	JPN 0R106999 and up	339-898103T	ECM
25 JET	FourStroke EFI	JPN 0R106999 and up	339-898103T	ECM
30 FourStroke	Carb	USA 0G760300 - 0G960499	339-830404T 3	ECM
		USA 0G960500 and up		
30 FourStroke	Carb	BEL 0P153500 and up	339-858942T 1	ECM
		USA 0T409000 - 0T979999		
30 FourStroke	EFI	BEL 0P153500 - 0P325499	339-877807A 2	ECM
		USA 0T980000 - 1B226999		
30 FourStroke	EFI	BEL 0P325500 - 0P400999	339-8M0077471	ECM
		JPN 0R106999 and up		
40 FourStroke	Carb, 3 cylinder	USA 0G760300 - 0G960499	339-830404T 3	ECM
		USA 0G960500 and up		
40 FourStroke	Carb, 3 cylinder	BEL 0P153500 and up	339-858942T 1	ECM
		CHN 1C000001 and up		
		USA 0T409000 - 0T979999		
40 FourStroke	EFI, 3 cylinder	BEL 0P153500 - 0P325499	339-877807A 2	ECM
		USA 0T980000 - 1B344398		
40 FourStroke	EFI, 3 cylinder	BEL 0P325500 - 0P515896	339-8M0077471	ECM
		CHN 1C000001 - 1C104333		
		CHN 1C104334 and up		
40 FourStroke	EFI, 3 cylinder	CHN 1C104334 and up	300-8M0045124	ECM
40 FourStroke	Carb, 4 cylinder	USA 0T228405 - 0T598999	339-859738T 1	ECM
		BEL 0P094500 - 0P206999		

Not all parts listed are available for the European, C.I.S., Africa and Middle East Markets.
For more information, please contact your local Mercury, Mariner, MerCruiser or Quicksilver Office.

IGNITION

MERCURY® OUTBOARDS

Model	Model Notes	Serial # Range	Ignition Coil	Switch Box or TPM Ass'y
40 FourStroke	EFI, 4 cylinder	USA 0T409000 - 0T979999	339-877807A 2	ECM
		BEL 0P153500 - 0P325499		
40 FourStroke	EFI, 4 cylinder	USA 0T980000 - 1B344398	339-8M0077471	ECM
		BEL 0P325500 and up		
		CHN 1C000001 - 1C104423		
40 FourStroke	EFI, 4 cylinder	CHN 1C104424 and up	300-8M0044991	ECM
45 FourStroke	Bodensee	USA 0G231123 - 0T178499	339-825101T	ECM
50 FourStroke		USA 0G231123 - 0T178499	339-825101T	ECM
50 FourStroke	Carb, 4 cylinder, 996cc	USA 0T178500 - 0T598999	339-859738T 1	ECM
		BEL 0P094500 - 0P206999		
50 FourStroke	EFI, 4 cylinder, 996cc	USA 0T409000 - 0T979999	339-877807A 2	ECM
		BEL 0P153500 - 0P325499		
50 FourStroke	EFI, 4 cylinder, 996cc	USA 0T980000 - 1B344398	339-8M0077471	ECM
		BEL 0P325500 and up		
		CHN 1C000001 - 1C104423		
50 FourStroke	EFI, 4 cylinder, 996cc	CHN 1C104424 and up	300-8M0044991	ECM
60 FourStroke	Carb, 4 cylinder, 996cc	USA 0T178500 - 0T598999	339-859738T 1	ECM
		BEL 0P094500 - 0P206999		
60 FourStroke	EFI, 4 cylinder, 996cc	USA 0T409000 - 0T979999	339-877807A 2	ECM
		BEL 0P153500 - 0P325499		
60 FourStroke	EFI, 4 cylinder, 996cc	USA 0T980000 - 1B344398	339-8M0077471	ECM
		BEL 0P325500 and up		
		CHN 1C000001 - 1C104423		
60 FourStroke	EFI, 4 cylinder, 996cc	CHN 1C104424 and up	300-8M0044991	ECM
75 FourStroke	Carb	USA 0G960500 - 1B226999	339-804271T	804269T 2
		USA 1B172291 - 1B366822		
75 FourStroke	EFI, 1596cc	USA 1B172291 - 1B366822	339-880892001	ECM
75 FourStroke	EFI, 1741cc	USA 1B366823 - 2B094995	339-880615T01	ECM
80 FourStroke	EFI, 1741cc	BEL 0P459572 and up	339-880615T01	ECM
75/80 FourStroke	2.1L	USA 2B094996 and up	300-8M0044991	ECM
		USA 0G960500 - 1B226999		
90 FourStroke		USA 0G960500 - 1B226999	339-804271T	804269T 2
90 FourStroke	EFI, 1596cc	USA 1B172291 - 1B366822	339-880892001	ECM
90 FourStroke	EFI, 1741cc	USA 1B366823 - 2B094995	339-880615T01	ECM
100 FourStroke	EFI, 1741cc	BEL 0P459572 and up	339-880615T01	ECM
90/100 FourStroke	2.1L	USA 2B094996 and up	300-8M0044991	ECM
115 FourStroke	EFI, Top Coil	USA 0T178500 - 1B366822	339-8M0121257	ECM
115 FourStroke	EFI, Bottom Coil	USA 0T178500 - 1B366822	300-8M0123821	ECM
115 FourStroke	EFI, 1741cc	USA 1B366823 - 2B094995	339-880615T01	ECM
115 FourStroke	2.1L	USA 2B094996 and up	300-8M0044991	ECM
135 Verado	4 cylinder	USA 1B227000 and up	339-880615T01	ECM
		BEL 0P419487 and up		
150 FourStroke	EFI	USA 1B905505 and up	300-8M0044991	ECM
150 Verado	4 cylinder	USA 1B227000 and up	339-880615T01	ECM
		BEL 0P419487 and up		
175 Verado	4 cylinder	USA 1B227000 and up	339-880615T01	ECM
		BEL 0P419487 and up		
200 Verado	4 cylinder	USA 1B517159 and up	339-880615T01	ECM
		BEL 0P514869 and up		
200 Verado	6 cylinder	USA 0T980000 and up	339-880615T01	ECM
		BEL 0P409357 and up		
225 FourStroke	EFI	USA 0T653945 and up	339-888309	ECM
225 Verado	6 cylinder	USA 0T980000 and up	339-880615T01	ECM
		BEL 0P409357 and up		
250 Verado	6 cylinder	USA 0T980000 and up	339-880615T01	ECM
		BEL 0P409357 and up		

Model	Model Notes	Serial # Range	Ignition Coil	Switch Box or TPM Ass'y
275 Verado	6 cylinder	USA 0T980000 and up	339-880615T01	ECM
		BEL 0P409357 and up		
300 Verado	6 cylinder	USA 1B517434 and up	339-880615T01	ECM
		BEL 0P520553 and up		
350Sci Verado	6 cylinder	USA 1B716557 - 2B143542	339-880615T01	ECM

IGNITION CHARTS - 2-CYCLE STANDARD COMPONENTS

Standard ignition component charts are located within this section. ECM modules and their application chart will be located in a separate section of its own.

2-Cycle Ignition Chart

Model	Serial # Range	Points	Condenser	Ignition Coil	Switch Box or TPM Ass'y	CDM Ass'y	Second CDM Ass'y	Distributor Cap	Rotor	Brush
2.2M	0A8075603 and up	N.L.A.	811598	N.L.A.	N/A	N/A	N/A	N/A	N/A	N/A
2.5 (Point ignition w/FOT0137 flywheel casting)	0A855097 and up	N.L.A.	811598	N.L.A.	N/A	N/A	N/A	N/A	N/A	N/A
2.5 (Point ignition w/FOT30071 flywheel casting)	0A855097 and up	N.L.A.	811598	N.L.A.	N/A	N/A	N/A	N/A	N/A	N/A
2.5 (CD Ignition)	USA 0A855097 and up	N/A	N/A	823033	823034T	N/A	N/A	N/A	N/A	N/A
	BEL 0P017000 and up									
3 (Point ignition w/FOT0137 flywheel casting)	0A855097 and up	N.L.A.	811598	N.L.A.	N/A	N/A	N/A	N/A	N/A	N/A
3 (Point ignition w/FOT30071 flywheel casting)	0A855097 and up	N.L.A.	811598	N.L.A.	N/A	N/A	N/A	N/A	N/A	N/A
3 (CD Ignition)	0A855097 and up	N/A	N/A	823033	823034T	N/A	N/A	N/A	N/A	N/A
3.3	USA 0D901217 and up	N/A	N/A	823033	823034T	N/A	N/A	N/A	N/A	N/A
	BEL 0P017000 and up									
3.5 (KF3)(Phelon ignition)	358136 - 358615	N.L.A.	N.L.A.	398- 173	N/A	N/A	N/A	N/A	N/A	N/A
3.5 (KF3)(Scintilla ignition)	358136 - 358615	N.L.A.	N.L.A.	N.L.A.	N/A	N/A	N/A	N/A	N/A	N/A
3.5	USA 6202173 and up	N/A	N/A	N.L.A.	N/A	N/A	N/A	N/A	N/A	N/A
	BEL 9252831 and up									
3.6 (Water cooled)	USA 5404657 and up	N/A	N/A	N.L.A.	N/A	N/A	N/A	N/A	N/A	N/A
	BEL 9252831 and up									
	CAN 7145388 and up									
3.9 (39)	1655013 - 2498155	N.L.A.	N.L.A.	398- 2568T 1	N/A	N/A	N/A	N/A	N/A	N/A
4 (1 cyl.)	USA 2498136 - 2693114	N.L.A.	N.L.A.	398- 2568T 1	N/A	N/A	N/A	N/A	N/A	N/A
4 (1 cyl.)	USA 2771622 - 0A809600	336- 4318A 2N/A		336- 4409A 4	N/A	N/A	N/A	N/A	N/A	N/A
	AUS 3306257 and up									
	BEL 9000306 - 9477829									
	CAN 3305152 and up									
4 (1 cyl.) A	USA 0A809601 and up	N/A	N/A	815113T02	16061T04	N/A	N/A	N/A	N/A	N/A
	BEL 9477830 and up									
4 (40, 4, Gnat)(2 cyl.)	USA 5589202 and up	N/A	N/A	339- 5288T 2	339- 6222A 8	N/A	N/A	N/A	N/A	N/A
	AUS 8065265 and up									
	BEL 9075839 and up									
	CAN 7085673 and up									
4.5 (1 cyl.)	USA 4107220 and up	336- 4318A 2N.L.A.		336- 4528T 2	N/A	N/A	N/A	N/A	N/A	N/A
	AUS 8026540 and up									
	BEL 9072179 and up									
	CAN 7045758 and up									
5 (KF5)(Phelon ignition)	338136 and up	N.L.A.	N.L.A.	398- 173	N/A	N/A	N/A	N/A	N/A	N/A
5 (KF5)(Scintilla ignition)	338136 and up	N.L.A.	N.L.A.	N.L.A.	N/A	N/A	N/A	N/A	N/A	N/A
5 (MARK 5)(Phelon ignition)	574128 - 786612	N.L.A.	N.L.A.	398- 173	N/A	N/A	N/A	N/A	N/A	N/A
5 (MARK 5)(Phelon ignition)	574128 - 786612	N.L.A.	N.L.A.	N.L.A.	N/A	N/A	N/A	N/A	N/A	N/A
5 (1 cyl.)	USA 0A809601 and up	N/A	N/A	815113T02	16061T04	N/A	N/A	N/A	N/A	N/A
	BEL 9477830 and up									

Not all parts listed are available for the European, C.I.S., Africa and Middle East Markets.
For more information, please contact your local Mercury, Mariner, MerCruiser or Quicksilver Office.

IGNITION

MERCURY® OUTBOARDS

Model	Serial # Range	Points	Condenser	Ignition Coil	Switch Box or TPM Ass'y	CDM Ass'y	Second CDM Ass'y	Distributor Cap	Rotor	Brush
5.9 (MARK 6)(Phelon Ignition)	888005 - 1134535	N.L.A.	N.L.A.	398- 173	N/A	N/A	N/A	N/A	N/A	N/A
5.9 (MARK 6)(Scintilla Ignition)	888005 - 1134535	N.L.A.	N.L.A.	N.L.A.	N/A	N/A	N/A	N/A	N/A	N/A
6 (MARK 6A)(Phelon Ignition)	1184570 and up	N.L.A.	N.L.A.	398- 173	N/A	N/A	N/A	N/A	N/A	N/A
6 (MARK 6A)(Scintilla Ignition)	1184570 and up	N.L.A.	N.L.A.	N.L.A.	N/A	N/A	N/A	N/A	N/A	N/A
6 (60)	1408611 - 1610264	N.L.A.	N.L.A.	398- 173	N/A	N/A	N/A	N/A	N/A	N/A
6 (60)	1610265 - 2529894	N.L.A.	N.L.A.	398- 2568T 1	N/A	N/A	N/A	N/A	N/A	N/A
6	USA 0A197112 - 0G760299	N/A	N/A	339- 832757A 4	339- 7452A19	N/A	N/A	N/A	N/A	N/A
	BEL 9461526 - 0P016999									
6	USA 0G760300 - 0T800749	N/A	N/A	339- 832757A 4	855713A 4	N/A	N/A	N/A	N/A	N/A
	BEL 0P017000 and up									
7.5 (KE4, KG4, MARK 7)(Phelon ignition)	214324 and up	N.L.A.	N.L.A.	398- 173	N/A	N/A	N/A	N/A	N/A	N/A
7.5 (KE4, KG4, MARK 7) (Scintilla ignition)	214324 and up	N.L.A.	N.L.A.	N.L.A.	N/A	N/A	N/A	N/A	N/A	N/A
7.5 (75)	2529895 - 2721150	N.L.A.	N.L.A.	398- 2568T 1	N/A	N/A	N/A	N/A	N/A	N/A
7.5 (75)	2810637 - 3274632	336- 4318A 2	N/A	336- 4409A 4	N/A	N/A	N/A	N/A	N/A	N/A
7.5 (75)	3274633 - 3801457	336- 4318A 2	N.L.A.	336- 4528T 2	N/A	N/A	N/A	N/A	N/A	N/A
7.5 (7.5, 75)	USA 3801458 and up	N/A	N/A	339- 5288T 2	899883229	N/A	N/A	N/A	N/A	N/A
	AUS 8015315 and up									
	BEL 9043194 and up									
	CAN 7028598 and up									
8	USA 0A197112 - 0G760299	N/A	N/A	339- 832757A 4	339- 7452A19	N/A	N/A	N/A	N/A	N/A
	BEL 9461526 - 0P016999									
8	USA 0G760300 and up	N/A	N/A	339- 832757A 4	855713A 4	N/A	N/A	N/A	N/A	N/A
	BEL 0P017000 and up									
8T Sea Pro	BEL 0N014717 and up	N/A	N/A	N/A	803704T01	N/A	N/A	N/A	N/A	N/A
9.8 (110)	1470349 - 1865778	N.L.A.	N.L.A.	398- 173	N/A	N/A	N/A	N/A	N/A	N/A
9.8 (110)	1865778 - 2708898	N.L.A.	N.L.A.	398- 2568T 1	N/A	N/A	N/A	N/A	N/A	N/A
9.8 (110)	2798057 - 3263262	336- 4318A 2	N/A	336- 4409A 4	N/A	N/A	N/A	N/A	N/A	N/A
9.8 (110)	3263263 - 3795657	336- 4318A 2	N.L.A.	336- 4528T 2	N/A	N/A	N/A	N/A	N/A	N/A
9.8 (9.8, 110)	USA 3795658 and up	N/A	N/A	339- 5288T 2	899883229	N/A	N/A	N/A	N/A	N/A
	AUS 8015040 and up									
	BEL 9041439 and up									
	CAN 7027323 and up									
9.8T	BEL 0N007788 - 0N055109	N/A	N/A	N/A	803704T01	N/A	N/A	N/A	N/A	N/A
9.9	USA 0A197112 - 0G760299	N/A	N/A	339- 832757A 4	339- 7452A19	N/A	N/A	N/A	N/A	N/A
	BEL 9461526 - 0P016999									
9.9	USA 0G760300 and up	N/A	N/A	339- 832757A 4	855713A 4	N/A	N/A	N/A	N/A	N/A
	BEL 0P017000 and up									
10 (KE7, KF7, KG7)(Phelon)		N.L.A.	N.L.A.	398- 173	N/A	N/A	N/A	N/A	N/A	N/A
10 (KE7, KF7, KG7)(Scintilla)		N.L.A.	N.L.A.	N.L.A.	N/A	N/A	N/A	N/A	N/A	N/A
10 (MARK 10A)	1120828 - 1122327	N.L.A.	N.L.A.	398- 173	N/A	N/A	N/A	N/A	N/A	N/A
10 (MARK 15)	595628 and up	N.L.A.	N.L.A.	398- 173	N/A	N/A	N/A	N/A	N/A	N/A
10 (100)	1290910 - 1455239	N.L.A.	N.L.A.	398- 173	N/A	N/A	N/A	N/A	N/A	N/A
10 (XR10/Sea Pro 10, Magnum, Marathon)	USA 0D038000 - 0G760299	N/A	N/A	339- 832757A 4	339- 7452A19	N/A	N/A	N/A	N/A	N/A
	BEL 9596000 - 0P016900									
10 (Sea Pro 10, Marathon)	USA 0G760300 and up	N/A	N/A	339- 832757A 4	855713A 3	N/A	N/A	N/A	N/A	N/A
	BEL 0P017000 and up									
10 (XR10/Magnum, Viking)	USA 0G760300 and up	N/A	N/A	339- 832757A 4	855713A 4	N/A	N/A	N/A	N/A	N/A
	BEL 0P017000 and up									
15 (150)	1200114 - 1499331	N.L.A.	N.L.A.	398- 173	N/A	N/A	N/A	N/A	N/A	N/A
15	USA 0B292414 - 0G760299	N/A	N/A	339- 832757A 4	339- 7452A19	N/A	N/A	N/A	N/A	N/A
	BEL 9542620 - 0P016999									
15	USA 0G760300 and up	N/A	N/A	339- 832757A 4	855713A 4	N/A	N/A	N/A	N/A	N/A

Model	Serial # Range	Points	Condenser	Ignition Coil	Switch Box or TPM Ass'y	CDM Ass'y	Second CDM Ass'y	Distributor Cap	Rotor	Brush
	BEL 0P017000 and up									
15T	BEL 0N001590 and up	N/A	N/A	8M0047313	803704T	N/A	N/A	N/A	N/A	N/A
15 (Sea Pro, Marathon)(Super)	USA 0G044027 - 0G437999	N/A	N/A	339-832757A 4	18495A30(4)	N/A	N/A	N/A	N/A	N/A
	BEL 9807909 - 9926999									
15 (Sea Pro, Marathon)(Super)	USA 0G438000 - 0G760299	N/A	N/A	339-832757A 4	339-7452A19	N/A	N/A	N/A	N/A	N/A
	BEL 9927000 - 0P016999									
15 (Sea Pro, Marathon)	USA 0G760300 and up	N/A	N/A	339-832757A 4	855713A 3	N/A	N/A	N/A	N/A	N/A
	BEL 0P017000 and up									
15XD Sea Pro/Marathon BigFoot	BEL 9927000 and up	N/A	N/A	339-832757A 4	339-7452A19	N/A	N/A	N/A	N/A	N/A
15 (Super)(Commercial)	USA 0G760300 and up	N/A	N/A	339-832757A 4	855713A 3	N/A	N/A	N/A	N/A	N/A
	BEL 0P017000 and up									
15 (Super)(Non-Commercial)	USA 0G760300 and up	N/A	N/A	339-832757A 4	855713A 4	N/A	N/A	N/A	N/A	N/A
	BEL 0P017000 and up									
15XD Sea Pro/Marathon(Commercial)	USA 0G760300 and up	N/A	N/A	339-832757A 4	855713A 3	N/A	N/A	N/A	N/A	N/A
	BEL 0P017000 and up									
15XD Sea Pro/Marathon(Non-Commercial)	USA 0G760300 and up	N/A	N/A	339-832757A 4	855713A 4	N/A	N/A	N/A	N/A	N/A
	BEL 0P017000 and up									
16 (MARK 20)		N.L.A.	N.L.A.	N.L.A.	N/A	N/A	N/A	N/A	N/A	N/A
18	USA 5837437 - 6443972	N/A	N/A	339-832757A 4	N.L.A.	N/A	N/A	N/A	N/A	N/A
	AUS 8071973 and up									
	BEL 9308306 - 9415100									
	CAN 7173723 - 7209532									
18XD with nut style connections	USA 6443973 and up	N/A	N/A	339-832757A 4	N.L.A.	N/A	N/A	N/A	N/A	N/A
	BEL 9378151 and up									
	CAN 7209533 and up									
18XD with bullet style connections	USA 6443973 and up	N/A	N/A	339-832757A 4	339-7452A19	N/A	N/A	N/A	N/A	N/A
	BEL 9378151 and up									
	CAN 7209533 and up									
20 (MARK 25, MARK 25E)	860979 and up	N.L.A.	N.L.A.	398-173	N/A	N/A	N/A	N/A	N/A	N/A
20 (200)	1558310 - 1592567	N.L.A.	N.L.A.	398-173	N/A	N/A	N/A	N/A	N/A	N/A
20 (200)	1592568 - 2827676	N.L.A.	N.L.A.	398-2568T 1	N/A	N/A	N/A	N/A	N/A	N/A
20 (200)	2827677 - 3226957	336-4318A 2	N/A	336-4409A 4	N/A	N/A	N/A	N/A	N/A	N/A
20 (200)	3226958 - 3537530	336-4318A 2	N.L.A.	336-4528T 2	N/A	N/A	N/A	N/A	N/A	N/A
20 (200)	USA 3537531 - 3755884	N/A	N/A	339-832757A 4	332-4911A 2	N/A	N/A	N/A	N/A	N/A
	AUS 8006265 - 8013704									
	BEL 9016254 - 9035128									
	CAN 7012358 - 7024647									
20 (200)	USA 3755885 - 4403786	N/A	N/A	339-5288T 2	332-4911A 2	N/A	N/A	N/A	N/A	N/A
	AUS 8013705 - 8039074									
	BEL 9035129 - 9122764									
	CAN 7024648 - 7077247									
20 (200)	USA 4403787 - 6443972	N/A	N/A	339-5288T 2	899883229	N/A	N/A	N/A	N/A	N/A
	AUS 8039075 - 9415100									
	BEL 9122765 - 9807907									
	CAN 7077248 - 7209532									
20 (20, 20XD)	USA 6443973 - 0G044026	N/A	N/A	339-832757A 4	339-7452A19	N/A	N/A	N/A	N/A	N/A
	BEL 9415101 - 9807908									
	CAN 7209533 and up									
20	USA 0G044027 - 0G437999	N/A	N/A	339-832757A 4	18495A30(4)	N/A	N/A	N/A	N/A	N/A
	BEL 9807909 - 9926999									
20	USA 0G438000 - 0G760299	N/A	N/A	339-832757A 4	339-7452A19	N/A	N/A	N/A	N/A	N/A

Not all parts listed are available for the European, C.I.S., Africa and Middle East Markets.
For more information, please contact your local Mercury, Mariner, MerCruiser or Quicksilver Office.

IGNITION

MERCURY® OUTBOARDS

Model	Serial # Range	Points	Condenser	Ignition Coil	Switch Box or TPM Ass'y	CDM Ass'y	Second CDM Ass'y	Distributor Cap	Rotor	Brush
	BEL 9927000 - 0P016999									
20 (Commercial)	USA 0G760300 - 0T800999	N/A	N/A	339-832757A 4	855713A 3	N/A	N/A	N/A	N/A	N/A
	BEL 0P017000 and up									
20 (Non-Commercial)	USA 0G760300 - 0T800999	N/A	N/A	339-832757A 4	855713A 4	N/A	N/A	N/A	N/A	N/A
	BEL 0P017000 and up									
20 JET	USA 0G044027 - 0G760299	N/A	N/A	339-832757A 4	18495A30(4)	N/A	N/A	N/A	N/A	N/A
	BEL 9807909 - 0P016999									
20 JET	USA 0G760300 and up	N/A	N/A	339-832757A 4	855713A 3	N/A	N/A	N/A	N/A	N/A
	BEL 0P017000 and up									
22 (MARK 22A)	1158546 - 1499331	N.L.A.	N.L.A.	398- 173	N/A	N/A	N/A	N/A	N/A	N/A
25 (KF9)	377150 - 379008	N.L.A.	394- 1130A 1	N.L.A.	N/A	N/A	N/A	N.L.A.	N.L.A.	N.L.A.
25 (KG9)	377150 - 379008	N.L.A.	394- 1130A 1	N.L.A.	N/A	N/A	N/A	N.L.A.	N.L.A.	N.L.A.
25 (MARK 40)	377150 - 379008	N.L.A.	394- 1130A 1	N.L.A.	N/A	N/A	N/A	N.L.A.	N.L.A.	N.L.A.
25 (250)	1200114 - 1499331	N.L.A.	N.L.A.	398- 173	N/A	N/A	N/A	N/A	N/A	N/A
25 (2 cyl.)	USA 5705532 - 6443972	N/A	N/A	339-832757A 4	N.L.A.	N/A	N/A	N/A	N/A	N/A
	AUS 8073158 and up									
	BEL 9315316 - 9415100									
	CAN 7166928 - 7209532									
25XD with nut style connections	USA 6443973 and up	N/A	N/A	339-832757A 4	N.L.A.	N/A	N/A	N/A	N/A	N/A
	BEL 9378151 and up									
	CAN 7209533 and up									
25XD with bullet style connections	USA 6443973 and up	N/A	N/A	339-832757A 4	339- 7452A19	N/A	N/A	N/A	N/A	N/A
	BEL 9378151 and up									
	CAN 7209533 and up									
25 (2 cyl.)	USA 0B238464 - 0G044026	N/A	N/A	339-832757A 4	339- 7452A19	N/A	N/A	N/A	N/A	N/A
	BEL 9507381 - 9807908									
	CAN 0A730007 and up									
25 (2 cyl.)	USA 0G044027 - 0G437999	N/A	N/A	339-832757A 4	18495A30(4)	N/A	N/A	N/A	N/A	N/A
	BEL 9807909 - 9926999									
25 (2 cyl.)	USA 0G438000 - 0G760299	N/A	N/A	339-832757A 4	339- 7452A19	N/A	N/A	N/A	N/A	N/A
	BEL 9927000 - 0P016999									
25 (Commercial)	USA 0G760300 and up	N/A	N/A	339-832757A 4	855713A 3	N/A	N/A	N/A	N/A	N/A
	BEL 0P017000 and up									
25 (Non-Commercial)	USA 0G760300 and up	N/A	N/A	339-832757A 4	855713A 4	N/A	N/A	N/A	N/A	N/A
	BEL 0P017000 and up									
25 (3 cyl.)	USA 0E268781 and up	N/A	N/A	N.L.A.	N/A	N/A	N/A	N/A	N/A	N/A
30 (MARK 30, MARK 55)		N.L.A.	394- 1130A 1	N.L.A.	N/A	N/A	N/A	N.L.A.	N.L.A.	N.L.A.
30 (300)	1271884 - 144139	N.L.A.	394- 1130A 1	N.L.A.	N/A	N/A	N/A	N.L.A.	N.L.A.	N.L.A.
30 (2 cyl.) 644cc	USA 0G053314 - 0G380074	N/A	N/A	N/A	N.L.A.	827509A12	N/A	N/A	N/A	N/A
30 (2 cyl.) 644cc, Manual	BEL 9854537 - 9928507									
30 (2 cyl.) 644cc, Electric	BEL 9854537 - 9928480									
30 (2 cyl.) 644cc	USA 0G380075 - 0G589999	N/A	N/A	N/A	N.L.A.	827509T 7	N/A	N/A	N/A	N/A
30 (2 cyl.) 644cc, Manual	BEL 9928508 - 9973099									
30 (2 cyl.) 644cc, Electric	BEL 9928481 - 9973099									
30 (2 cyl.) 644cc	USA 0G590000 - 0T598999	N/A	N/A	N/A	N/A	827509T 7	N/A	N/A	N/A	N/A
	BEL 9973100 and up									
30 JET	USA 0C159200 - 0G589999	N/A	N/A	339-832757A 4	332- 5772A 7	N/A	N/A	N/A	N/A	N/A
30 JET	USA 0G590000 - 0T178499	N/A	N/A	N/A	N/A	827509T 7	827509A10	N/A	N/A	N/A
35 (350)	1271884 - 1448139	N.L.A.	394- 1130A 1	N.L.A.	N/A	N/A	N/A	N.L.A.	N.L.A.	N.L.A.
35 (35A)	1271884 - 1448139	N.L.A.	394- 1130A 1	N.L.A.	N/A	N/A	N/A	N.L.A.	N.L.A.	N.L.A.
35 (350)	157114 - 2874703	N.L.A.	N.L.A.	398- 2568T 1	N/A	N/A	N/A	N/A	N/A	N/A

Model	Serial # Range	Points	Condenser	Ignition Coil	Switch Box or TPM Ass'y	CDM Ass'y	Second CDM Ass'y	Distributor Cap	Rotor	Brush
35 (2cyl.) with nut style connections	USA 6445653 - 0B110788	N/A	N/A	339- 832757A 4	N.L.A.	N/A	N/A	N/A	N/A	N/A
	BEL 9384476 - 9466646									
	CAN 7209608 and up									
35 (2 cyl.) with bullet style connections	USA 6445653 - 0B110788	N/A	N/A	339- 832757A 4	N/A	N/A	N/A	N/A	N/A	N/A
	BEL 9384476 - 9466646									
	CAN 7209608 and up									
35 (2 cyl.)	USA 0B110789 and up	N/A	N/A	339- 832757A 4	N/A	N/A	N/A	N/A	N/A	N/A
	BEL 9466647 and up									
40 (400)(4 cyl.)	1279685 - 1476509	N.L.A.	394- 1130A 1	N.L.A.	N/A	N/A	N/A	N.L.A.	N.L.A.	N.L.A.
40 (402)(2 cyl.)	USA 3336258 - 3859434	N/A	N/A	339- 832757A 4	N.L.A.	N/A	N/A	N/A	N/A	N/A
	AUS 8002335 - 8016689									
	BEL 3339688 - 9051458									
	CAN 3340783 - 7032137									
40 (40, 402)(2 cyl.)	USA 3859435 - 5823917	N/A	N/A	339- 5288T 2	332- 4911A 8	N/A	N/A	N/A	N/A	N/A
	AUS 8016690 - 8070639									
	BEL 9051459 - 9298955									
	CAN 7032138 - 7169337									
40 (2 cyl.)	USA 5823918 - 6443973	N/A	N/A	339- 832757A 4	N.L.A.	N/A	N/A	N/A	N/A	N/A
	AUS 8070640 and up									
	BEL 9298956 - 9415101									
	CAN 7169338 and up									
40 (2 cyl.) 644cc	USA 0G053314 - 0G380074	N/A	N/A	N/A	N.L.A.	827509A12	N/A	N/A	N/A	N/A
40 (2 cyl.) 644cc, Manual	BEL 9854537 - 9928507									
40 (2 cyl.) 644cc, Electric	BEL 9854537 - 9928480									
40 (2 cyl.) 644cc	USA 0G380075 - 0G589999	N/A	N/A	N/A	N.L.A.	827509T 7	N/A	N/A	N/A	N/A
40 (2 cyl.) 644cc, Manual	BEL 9928508 - 9973099									
40 (2 cyl.) 644cc, Electric	BEL 9928481 - 9973099									
40 (2 cyl.) 644cc	USA 0G590000 and up	N/A	N/A	N/A	N/A	827509T 7	N/A	N/A	N/A	N/A
	BEL 9973100 and up									
40 (3 cyl.)	USA 0G531301 - 0T999999	N/A	N/A	N/A	N/A	827509T 7(1)	827509A10(2)	N/A	N/A	N/A
	BEL 9973100 and up									
40 (Lightning)	0N000001 and up	N/A	N/A	16064006	16061005	N/A	N/A	N/A	N/A	N/A
40XR (Lightning)	0N000513 and up	N/A	N/A	16064006	16061005	N/A	N/A	N/A	N/A	N/A
40 (4 cyl.)	USA 0C159200 and up	N/A	N/A	339- 832757A 4	332- 5772A 7	N/A	N/A	N/A	N/A	N/A
	BEL 9570790 and up									
40 JET	USA 0T178500 and up	N/A	N/A	N/A	N/A	827509T 7(1)	827509A10(2)	N/A	N/A	N/A
	BEL 0P094500 and up									
45 (MARK 58,E,AM,AE)(MARK 55AE,AM)	1139538 and up	N.L.A.	394- 1130A 1	N.L.A.	N/A	N/A	N/A	N.L.A.	N.L.A.	N.L.A.
45 (450)(4 cyl.)	1476510 - 1531958	N.L.A.	394- 1130A 1	N.L.A.	N/A	N/A	N/A	N.L.A.	N.L.A.	N.L.A.
45 (4 cyl.)	USA 5531630 and up	N/A	N/A	339- 832757A 4	332- 5772A 7	N/A	N/A	N/A	N/A	N/A
	AUS 8063985 and up									
	BEL 9248006 and up									
	CAN 7143688 and up									
45 JET (3 cyl.)	USA 0G290584 - 0G589999	N/A	N/A	339- 832757A 4	19052A 8	N/A	N/A	N/A	N/A	N/A
	USA 0G590000 - 0G760299									
45 JET (3 cyl.)	USA 0G760300 - 0T178499	N/A	N/A	N/A	N/A	827509T 7(1)	827509A10(2)	N/A	N/A	N/A
	BEL 0P017000 - 0P094499									
50 (500)(4 cyl.)	USA 1421113 - 2305100	N.L.A.	394- 1130A 1	N.L.A.	N/A	N/A	N/A	N.L.A.	N.L.A.	N.L.A.
	CAN 1755549 - 2305100									
50 (500)(4 cyl.)	2305101 - 2858813	N/A	N/A	N.L.A.	333- 3213A 3	N/A	N/A	N.L.A.	N.L.A.	393- 1293A 1
50 (500E-7-SS)(4 cyl.)	2305101 - 2858813	N/A	N/A	N.L.A.	332- 2986A27	N/A	N/A	N.L.A.	N.L.A.	393- 1293A 1

Not all parts listed are available for the European, C.I.S., Africa and Middle East Markets.
For more information, please contact your local Mercury, Mariner, MerCruiser or Quicksilver Office.

IGNITION

MERCURY® OUTBOARDS

Model	Serial # Range	Points	Condenser	Ignition Coil	Switch Box or TPM Ass'y	CDM Ass'y	Second CDM Ass'y	Distributor Cap	Rotor	Brush
50 (500)(4 cyl.)	USA 2858814 - 4140999	N/A	N/A	N.L.A.	333- 3213A 3	N/A	N/A	N.L.A.	N.L.A.	N.L.A.
	AUS 2863739 - 8029514									
	BEL 9001581 - 9082513									
	CAN 2742142 - 7051982									
50 (500)(4 cyl.)	USA 4141000 - 4357639	N/A	N/A	332- 4895T 2	333- 3213A 3	N/A	N/A	N.L.A.	N.L.A.	N.L.A.
	AUS 8029515 - 8030089									
	BEL 9082514 - 9107213									
	CAN 7051983 - 7068997									
50 (50, 500)(4 cyl.)	USA 4357640 - 5193258	N/A	N/A	339- 5288T 2	332- 5772A 7	N/A	N/A	N/A	N/A	N/A
	AUS 8030090 - 8057394									
	BEL 9107214 - 9217255									
	CAN 7068998 - 7116222									
50 (50, 500)(4 cyl.)	USA 5193259 - 5531629	N/A	N/A	339-832757A 4	332- 5772A 7	N/A	N/A	N/A	N/A	N/A
	AUS 8057395 - 8063984									
	BEL 9217256 - 9248005									
	CAN 7116223 - 7143687									
50 (4 cyl.)	USA 5531630 and up	N/A	N/A	339 832757A 4	332- 5772A 7	N/A	N/A	N/A	N/A	N/A
	AUS 8063985 and up									
	BEL 9248006 and up									
	CAN 7143688 and up									
50 (3 cyl.)	USA 6428681 - 0D000749	N/A	N/A	339-832757A 4	332- 7778A12	N/A	N/A	N/A	N/A	N/A
	BEL 9385911 - 9683054									
	CAN 7208333 and up									
50 (3 cyl.)	USA 0D000750 - 0G589999	N/A	N/A	339-832757A 4	19052A 8	N/A	N/A	N/A	N/A	N/A
	BEL 9683055 - 9973099									
50 (3 cyl.)	USA 0G590000 - 0T999999	N/A	N/A	N/A	N/A	827509T 7(1)	827509A10(2)	N/A	N/A	N/A
	BEL 9973100 and up									
55 (3 cyl.)	USA 0D000750 - 0G589999	N/A	N/A	339-832757A 4	19052A 8	N/A	N/A	N/A	N/A	N/A
	BEL 9683055 - 9973099									
55 (3 cyl.)	USA 0G590000 - 0G760299	N/A	N/A	N/A	N/A	827509T 7	N/A	N/A	N/A	N/A
	BEL 9973100 - 0P016999									
55 (3 cyl.)	USA 0G760300 and up	N/A	N/A	N/A	N/A	827509T 7(1)	827509A10(2)	N/A	N/A	N/A
	BEL 0P017000 and up									
60 (MARK 75)	1072997 and up	N.L.A.	N.L.A.	898253T24	N/A	N/A	N/A	N.L.A.	393- 1280A 1	393- 1293A 1(3)
60 (600)(6 cyl.)	1303411 - 1542744	N.L.A.	N/A	898253T24	N/A	N/A	N/A	N.L.A.	393- 1280A 1	393- 1293A 1(3)
60 (3 cyl.)	USA 6428681 - 0D000749	N/A	N/A	339-832757A 4	332- 7778A12	N/A	N/A	N/A	N/A	N/A
	BEL 9385911 - 9683054									
	CAN 7208333 and up									
60 (3 cyl.)	USA 0D000750 - 0G589999	N/A	N/A	339-832757A 4	19052A 8	N/A	N/A	N/A	N/A	N/A
	BEL 9683055 - 9973099									
60 (3 cyl.)	USA 0G590000 - 0G760299	N/A	N/A	N/A	N/A	827509T 7	N/A	N/A	N/A	N/A
	BEL 9973100 - 0P016999									
60 (3 cyl.)	USA 0G760300 and up	N/A	N/A	N/A	N/A	827509T 7(1)	827509A10(2)	N/A	N/A	N/A
	BEL 0P017000 and up									
65 (650)(4 cyl.)	1542745 - 2309310	N.L.A.	394- 1130A 1	N.L.A.	N/A	N/A	N/A	N.L.A.	N.L.A.	N.L.A.
65 (650)(4 cyl.)	2309311 - 2803561	N/A	N/A	332- 4895A 5	333- 3213A 3	N/A	N/A	N.L.A.	N.L.A.	N.L.A.
65 (650E-5-SS)(4 cyl.)	2309311 - 2803561	N/A	N/A	332- 4895A 5	332- 2986A27	N/A	N/A	N.L.A.	N.L.A.	N.L.A.
65 (650)(4 cyl.)	2803562 - 2874263	N/A	N/A	332- 4895A 5	332- 2986A27	N/A	N/A	N.L.A.	N.L.A.	393- 1293A 1
65 (650)(4 cyl.)	2997339 - 3293183	N/A	N/A	332- 4895A 5	332- 2986A27	N/A	N/A	N.L.A.	N.L.A.	393- 1293A 1
65 (650)(3 cyl.)(With 3 3/8 inch High Coil)	3293184 - 3525440	N/A	N/A	332- 4895T 2	N.L.A.	N/A	N/A	N.L.A.	N.L.A.	393- 1293A 1
65 (650)(3 cyl.)(With 2 7/8 inch High Coil)	3293184 - 3525440	N/A	N/A	N.L.A.	N.L.A.	N/A	N/A	N.L.A.	N.L.A.	393- 1293A 1

Model	Serial # Range	Points	Condenser	Ignition Coil	Switch Box or TPM Ass'y	CDM Ass'y	Second CDM Ass'y	Distributor Cap	Rotor	Brush
65 (650)(3 cyl.)	USA 3547987 - 4382056	N/A	N/A	332- 4895T 2	N.L.A.	N/A	N/A	N.L.A.	N.L.A.	393- 1293A 1
	AUS 8006640 - 8042349									
	BEL 9020074 - 9112988									
	CAN 7013633 - 7073472									
65 (650)(3 cyl.)	USA 4382057 - 4571651	N/A	N/A	339- 5288T 2	332- 7778A12	N/A	N/A	N/A	N/A	N/A
	BEL 9112989 - 9135824									
	CAN 7073473 - 7087822									
65 JET	USA 0D283222 - 0G437999	N/A	N/A	339- 832757A 4	18495A26	N/A	N/A	N/A	N/A	N/A
	BEL 9793577 - 9926999									
65 JET	USA 0G438000 and up	N/A	N/A	N/A	N/A	827509A10	N/A	N/A	N/A	N/A
	BEL 9927000 and up									
70 (MARK 78,78A)(MARK 75A)	1110600 and up	N.L.A.	N.L.A.	898253T24	N/A	N/A	N/A	N.L.A.	393- 1280A 1	393- 1293A 1(3)
70 (700)(6 cyl.)	1296411 - 1566239	N.L.A.	N.L.A.	898253T24	N/A	N/A	N/A	N.L.A.	393- 1280A 1	393- 1293A 1(3)
70 (3 cyl.)	USA 4571652 - 5128279	N/A	N/A	339- 5288T 2	332- 7778A12	N/A	N/A	N/A	N/A	N/A
	AUS 8042350 - 8056219									
	BEL 9135825 - 9207525									
	CAN 7087823 - 7110997									
70 (3 cyl.)	USA 5128280 and up	N/A	N/A	339- 832757A 4	332- 7778A12	N/A	N/A	N/A	N/A	N/A
	AUS 8056220 and up									
	BEL 9207526 and up									
	CAN 7110998 and up									
75 (4 cyl.)	USA 6432901 and up	N/A	N/A	339- 832757A 4	332- 5772A 7	N/A	N/A	N/A	N/A	N/A
	BEL 9393856 and up									
	CAN 7208573 and up									
75 (3 cyl.)	USA 0C222000 - 0D283221	N/A	N/A	339- 832757A 4	332- 7778A12	N/A	N/A	N/A	N/A	N/A
	BEL 9589039 - 9793576									
75 (3 cyl.)	USA 0D283222 - 0G437999	N/A	N/A	339- 832757A 4	18495A26	N/A	N/A	N/A	N/A	N/A
	BEL 9793577 - 9926999									
75 (3 cyl.)	USA 0G438000 and up	N/A	N/A	N/A	N/A	827509A10	N/A	N/A	N/A	N/A
	BEL 9927000 and up									
75 (3 cyl) Optimax	USA 0T801000 and up	N/A	N/A	339- 8M0077471	N/A	N/A	N/A	N/A	N/A	N/A
80 (800)(6 cyl.)	1335465 - 1566239	N.L.A.	N.L.A.	898253T24	N/A	N/A	N/A	N.L.A.	393- 1280A 1	393- 1293A 1(3)
80 (800)(4 cyl.)	2559001 - 3493912	N/A	N/A	332- 4895A 5	332- 2986A27	N/A	N/A	N.L.A.	N.L.A.	393- 1293A 1
80 (80, 800)(4 cyl.)	USA 483199 - 5141096	N/A	N/A	339- 5288T 2	332- 5772A 7	N/A	N/A	N/A	N/A	N/A
	AUS 8050200 - 8056519									
	BEL 9177626 - 9207925									
	CAN 7110998 - 7122587									
80 (4 cyl.)	USA 5141097 - 6432900	N/A	N/A	339- 832757A 4	332- 5772A 7	N/A	N/A	N/A	N/A	N/A
	AUS 8056520 and up									
	BEL 9207926 - 9393855									
	CAN 7122588 - 7208572									
80 (3 cyl.)	USA 0A996142 and up	N/A	N/A	339- 832757A 4	332- 7778A12	N/A	N/A	N/A	N/A	N/A
	BEL 9483121 and up									
80 JET	USA 0D283222 - 0G437999	N/A	N/A	339- 832757A 4	332- 5772A 7	N/A	N/A	N/A	N/A	N/A
	BEL 9793577 - 9926999									
80 JET	USA 0G438000 and up	N/A	N/A	N/A	N/A	827509A10	N/A	N/A	N/A	N/A
	BEL 9927000 and up									
85 (850)(6 cyl.)	1460999 - 1766823	N.L.A.	N.L.A.	898253T24	N/A	N/A	N/A	N.L.A.	393- 1280A 1	393- 1293A 1(3)
85 (850)(4 cyl.)	USA 3493913 - 3865694	N/A	N/A	332- 4895A 5	332- 2986A27	N/A	N/A	N.L.A.	N.L.A.	393- 1293A 1
	AUS 8005440 - 8017139									
	BEL 9011604 - 9053363									
	CAN 7010108 - 7033027									

Not all parts listed are available for the European, C.I.S., Africa and Middle East Markets.
For more information, please contact your local Mercury, Mariner, MerCruiser or Quicksilver Office.

IGNITION

MERCURY® OUTBOARDS

Model	Serial # Range	Points	Condenser	Ignition Coil	Switch Box or TPM Ass'y	CDM Ass'y	Second CDM Ass'y	Distributor Cap	Rotor	Brush
85 (850)(4 cyl.)	USA 3865695 - 4366801	N/A	N/A	332- 4895T 2	332- 2986A27	N/A	N/A	N.L.A.	N.L.A.	393- 1293A 1
	AUS 8017140 - 8043774									
	BEL 9053364 - 9110013									
	CAN 7033028 - 7071372									
85 (850)(4 cyl.)	USA 4366802 - 4831998	N/A	N/A	339- 5288T 2	332- 5772A 7	N/A	N/A	N/A	N/A	N/A
	AUS 8043775 - 8050199									
	BEL 9110014 - 9177625									
	CAN 7071373 - 7110997									
90 (900)(6 cyl.)	1766824 - 1869775	N.L.A.	N.L.A.	898253T24	N/A	N/A	N/A	N.L.A.	393- 1280A 1	393- 1293A 1(3)
90 (90, 900)(6 cyl.)	USA 4845301 - 5299505	N/A	N/A	332- 4895T 2	332- 2986A21	N/A	N/A	N.L.A.	N.L.A.	393- 1293A 1
	CAN 7111698 - 7123762									
90 (6 cyl.)	USA 5299506 and up	N/A	N/A	339- 832757A 4	332- 7778A12	N/A	N/A	N/A	N/A	N/A
	AUS 8060545 and up									
	CAN 7147088 and up									
90 (3 cyl.)	USA 0A996142 - 0D283221	N/A	N/A	339- 832757A 4	332- 7778A12	N/A	N/A	N/A	N/A	N/A
	BEL 9483121 - 9793576									
90 (3 cyl.)	USA 0D283222 - 0G437999	N/A	N/A	339- 832757A 4	18495A26	N/A	N/A	N/A	N/A	N/A
	BEL 9793577 - 9926999									
90 (3 cyl.)	USA 0G438000 and up	N/A	N/A	N/A	N/A	827509A10	N/A	N/A	N/A	N/A
	BEL 9927000 and up									
90 (3 cyl) Optimax	USA 0T801000 and up	N/A	N/A	339- 8M0077471	N/A	N/A	N/A	N/A	N/A	N/A
95 (950)(6 cyl.)	1869776 - 2318585	N.L.A.	N.L.A.	898253T24	N/A	N/A	N/A	N.L.A.	393- 1280A 1	393- 1293A 1(3)
100 (1000)(6 cyl.)	1464949 - 2318585	N.L.A.	N.L.A.	898253T24	N/A	N/A	N/A	N.L.A.	393- 1280A 1	393- 1293A 1(3)
100 (1000)(6 cyl.)	2318586 - 2836018	N/A	N/A	332- 4895A 5	332- 2986A21	N/A	N/A	N.L.A.	N.L.A.	393- 1293A 1
100 (1000BP)(6 cyl.)	2399698 - 2641854	N/A	N/A	332- 4895A 5	N.L.A.	N/A	N/A	N.L.A.	N.L.A.	393- 1293A 1
100 (1000BP)(6 cyl.)	2641855 - 3253111	N/A	N/A	332- 4895A 5	N.L.A.	N/A	N/A	N.L.A.	N.L.A.	393- 1293A 1
100 (4 cyl.)	USA 0B209468 - 0G437999	N/A	N/A	339- 832757A 4	332- 5772A 7	N/A	N/A	N/A	N/A	N/A
	BEL 9523034 - 9926999									
100 (4 cyl.)	USA 0G438000 and up	N/A	N/A	N/A	N/A	827509A10	N/A	N/A	N/A	N/A
	BEL 9927000 and up									
110 (1100)(6 cyl.)	1870204 - 2314955	N.L.A.	N.L.A.	898253T24	N/A	N/A	N/A	N.L.A.	393- 1280A 1	393- 1293A 1(3)
115 (1150)(6 cyl.)	USA 2836019 - 2928720	N/A	N/A	332- 4895A 5	332- 2986A21	N/A	N/A	N.L.A.	N.L.A.	393- 1293A 1
115 (1150)(6 cyl.)	USA 2928721 - 4112634	N/A	N/A	332- 4895A 5	332- 2986A21	N/A	N/A	N.L.A.	N.L.A.	393- 1293A 1
	AUS 8008865 - 8027114									
	CAN 7010763 - 7047257									
115 (115, 1150)(6 cyl.)	USA 4112635 - 5314655	N/A	N/A	332- 4895T 2	332- 2986A21	N/A	N/A	N.L.A.	N.L.A.	393- 1293A 1
	AUS 8027115 - 8061119									
	CAN 7047258 - 7131212									
115 (6 cyl.)	USA 5314656 and up	N/A	N/A	339- 832757A 4	332- 7778A12	N/A	N/A	N/A	N/A	N/A
	AUS 8061120 and up									
	CAN 7131213 and up									
115 (4 cyl.)	USA 0B209468 - 0G437999	N/A	N/A	339- 832757A 4	332- 5772A 7	N/A	N/A	N/A	N/A	N/A
	BEL 9523034 - 9926999									
115 (4 cyl.)	USA 0G438000 and up	N/A	N/A	N/A	N/A	827509A10	N/A	N/A	N/A	N/A
	BEL 9927000 and up									
115 (3 cyl) Optimax	USA 0T801000 and up	N/A	N/A	339- 8M0077471	N/A	N/A	N/A	N/A	N/A	N/A
115 (3 cyl.) Pro XS	USA 1B751825 and up	N/A	N/A	339- 8M0077471	N/A	N/A	N/A	N/A	N/A	N/A
125 (1250)(6 cyl.)	2314956 - 2839368	N/A	N/A	332- 4895A 5	332- 2986A21	N/A	N/A	N.L.A.	N.L.A.	393- 1293A 1
125 (1250BP)(6 cyl.)	2400058 - 2641854	N/A	N/A	332- 4895A 5	N.L.A.	N/A	N/A	N.L.A.	N.L.A.	393- 1293A 1
125 (1250BP)(6 cyl.)	2641855 - 3253111	N/A	N/A	332- 4895A 5	N.L.A.	N/A	N/A	N.L.A.	N.L.A.	393- 1293A 1
125 (4 cyl.)	USA 0D283222 - 0G437999	N/A	N/A	339- 832757A 4	332- 5772A 7	N/A	N/A	N/A	N/A	N/A
	BEL 9793577 - 9926999									
125 (4 cyl.)	USA 0G438000 and up	N/A	N/A	N/A	N/A	827509A10	N/A	N/A	N/A	N/A
	BEL 9927000 and up									

Model	Serial # Range	Points	Condenser	Ignition Coil	Switch Box or TPM Ass'y	CDM Ass'y	Second CDM Ass'y	Distributor Cap	Rotor	Brush
125 (3 cyl.) Optimax	USA 1B736885 and up	N/A	N/A	339-8M0077471	N/A	N/A	N/A	N/A	N/A	N/A
135 (1350)(6 cyl.)	2839369 - 2940020	N/A	N/A	332- 4895A 5	332- 2986A21	N/A	N/A	N.L.A.	N.L.A.	393- 1293A 1
135 (1350)(6 cyl.)	2940021 - 3293233	N/A	N/A	332- 4895A 5	332- 2986A21	N/A	N/A	N.L.A.	N.L.A.	393- 1293A 1
140 (1400)(6 cyl.)	3293234 - 3502805	N/A	N/A	332- 4895A 5	332- 2986A21	N/A	N/A	N.L.A.	N.L.A.	393- 1293A 1
140 (140, 1400)(6 cyl.)	USA 4865678 - 5327662	N/A	N/A	332- 4895T 2	332- 2986A21	N/A	N/A	N.L.A.	N.L.A.	393- 1293A 1
	AUS 8052650 - 8052879									
	CAN 7112773 - 7132512									
140 (6 cyl.)	USA 5327663 and up	N/A	N/A	339-832757A 4	332- 7778A12	N/A	N/A	N/A	N/A	N/A
	AUS 8066065 and up									
	CAN 7132513 and up									
150 (1500)(6 cyl.)	USA 3502806 - 4121434	N/A	N/A	332- 4895A 5	332- 2986A21	N/A	N/A	N.L.A.	N.L.A.	393- 1293A 1
	AUS 8005615 - 8028039									
	CAN 7010533 - 7048782									
150 (1500)(6 cyl.)	USA 4121435 - 4865677	N/A	N/A	332- 4895T 2	332- 2986A21	N/A	N/A	N.L.A.	N.L.A.	393- 1293A 1
	AUS 8028040 - 8052649									
	CAN 7048783 - 7112772									
150 (1500XS)(6 cyl.)	USA 4868648 - 5327662	N/A	N/A	332- 4895T 2	N.L.A.	N/A	N/A	N.L.A.	N.L.A.	393- 1293A 1
V-105 JET	USA 0D082000 and up	N/A	N/A	339-832757A 4	332- 7778A12	N/A	N/A	N/A	N/A	N/A
V-135	USA 0A904646 - 0G960499	N/A	N/A	339-832757A 4	332- 7778A12	N/A	N/A	N/A	N/A	N/A
V-135	USA 0G960500 - 0T178499	N/A	N/A	N/A	N/A	827509T 7	N/A	N/A	N/A	N/A
V-135 DFI	USA 0G590000 - 1B490865	N/A	N/A	339-856991A 1	N/A	N/A	N/A	N/A	N/A	N/A
V-135 DFI	USA 1B490866 and up	N/A	N/A	339-8M0077473	N/A	N/A	N/A	N/A	N/A	N/A
V-140 JET	USA 0D082000 - 0T178499	N/A	N/A	339-832757A 4	332- 7778A12	N/A	N/A	N/A	N/A	N/A
V-150 (150, 1500) w/orange coils	USA 4868998 - 0A904645	N/A	N/A	339- 5288T 2	332- 7778A12	N/A	N/A	N/A	N/A	N/A
V-150 (150, 1500) w/navy blue coils	USA 4868998 - 0A904645	N/A	N/A	339-832757A 4	332- 7778A12	N/A	N/A	N/A	N/A	N/A
V-150	USA 0A904646 - 0G960499	N/A	N/A	339-832757A 4	332- 7778A12	N/A	N/A	N/A	N/A	N/A
V-150	USA 0G960500 and up	N/A	N/A	N/A	N/A	827509T 7	N/A	N/A	N/A	N/A
V-150 EFI	USA 0D082000 - 0G960499	N/A	N/A	339-832757A 4	332- 7778A12	N/A	N/A	N/A	N/A	N/A
V-150 EFI	USA 0G960500 - 0T408999	N/A	N/A	N/A	N/A	827509T 7	N/A	N/A	N/A	N/A
V-150 EFI	USA 0T409000 and up	N/A	N/A	339-8M0077471	N/A	N/A	N/A	N/A	N/A	N/A
V-150 DFI	USA 0G590000 - 1B490865	N/A	N/A	339-856991A 1	N/A	N/A	N/A	N/A	N/A	N/A
V-150 DFI	USA 1B490866 and up	N/A	N/A	339-8M0077473	N/A	N/A	N/A	N/A	N/A	N/A
V-150 ProXS	USA 1B690542 and up	N/A	N/A	339-8M0077473	N/A	N/A	N/A	N/A	N/A	N/A
V-175 (175, 1750)	USA 4301235 - 5180108	N/A	N/A	339- 5288T 2	332- 7778A12	N/A	N/A	N/A	N/A	N/A
V-175 (175, 1750)	USA 5180109 - 0G960499	N/A	N/A	339-832757A 4	332- 7778A12	N/A	N/A	N/A	N/A	N/A
	AUS 8064250 and up									
V-175 EFI	USA 0D000750 - 0G960499	N/A	N/A	339-832757A 4	332- 7778A12	N/A	N/A	N/A	N/A	N/A
V-175 EFI	USA 0G960500 - 0T408999	N/A	N/A	N/A	N/A	827509T 7	N/A	N/A	N/A	N/A
V-175 EFI	USA 0T409000 - 0T800999	N/A	N/A	339-8M0077471	N/A	N/A	N/A	N/A	N/A	N/A
V-175 DFI	USA 0T178500 - 1B490865	N/A	N/A	339-856991A 1	N/A	N/A	N/A	N/A	N/A	N/A
V-175 DFI	USA 1B490866 and up	N/A	N/A	339-8M0077473	N/A	N/A	N/A	N/A	N/A	N/A
V-175 Pro XS	USA 1B516339 and up	N/A	N/A	339-8M0077471	N/A	N/A	N/A	N/A	N/A	N/A
V-200 (200, 2000) w/orange coils	USA 4839034 - 5363917	N/A	N/A	339- 5288T 2	332- 7778A12	N/A	N/A	N/A	N/A	N/A
V-200 (200, 2000) w/navy blue coils	USA 4839034 - 5363917	N/A	N/A	339-832757A 4	332- 7778A12	N/A	N/A	N/A	N/A	N/A
V-200	USA 5363918 - 0G960499	N/A	N/A	339-832757A 4	332- 7778A12	N/A	N/A	N/A	N/A	N/A
	AUS 8061595 and up									
V-200	USA 0G960500 and up	N/A	N/A	N/A	N/A	827509T 7	N/A	N/A	N/A	N/A
V-200 EFI	USA 0C100861 - 0G960499	N/A	N/A	339-832757A 4	332- 7778A12	N/A	N/A	N/A	N/A	N/A
V-200 EFI	USA 0G303046 - 0T408999	N/A	N/A	N/A	N/A	827509T 7	N/A	N/A	N/A	N/A
V-200 EFI (2.5L)	USA 0T409000 and up	N/A	N/A	339-8M0077471	N/A	N/A	N/A	N/A	N/A	N/A

Not all parts listed are available for the European, C.I.S., Africa and Middle East Markets.
For more information, please contact your local Mercury, Mariner, MerCruiser or Quicksilver Office.

IGNITION

MERCURY® OUTBOARDS

Model	Serial # Range	Points	Condenser	Ignition Coil	Switch Box or TPM Ass'y	CDM Ass'y	Second CDM Ass'y	Distributor Cap	Rotor	Brush
V-200 EFI (3.0L)	USA 0T750164 and up	N/A	N/A	339-8M0077471	N/A	N/A	N/A	N/A	N/A	N/A
V-200 DFI	USA 0G386496 - 0G589999	N/A	N/A	N.L.A.	N/A	N/A	N/A	N/A	N/A	N/A
V-200 DFI	USA 0G590000 - 1B504988	N/A	N/A	339-856991A 1	N/A	N/A	N/A	N/A	N/A	N/A
V-200 DFI	USA 1B504989 and up	N/A	N/A	339-8M0077473	N/A	N/A	N/A	N/A	N/A	N/A
V-200 Pro XS	USA 1B504989 and up	N/A	N/A	339-8M0077473	N/A	N/A	N/A	N/A	N/A	N/A
V-220 EFI	USA 0B117316 and up	N/A	N/A	339-832757A 4	332- 7778A12	N/A	N/A	N/A	N/A	N/A
V-225 (2.4L)	USA 5628028 and up	N/A	N/A	339-832757A 4	332- 7778A12	N/A	N/A	N/A	N/A	N/A
V-225 (3.0L)	USA 0D280813 - 0G303045	N/A	N/A	N/A	N/A	827509A12	N/A	N/A	N/A	N/A
V-225 (3.0L)	USA 0G303046 - 0T408999	N/A	N/A	N/A	N/A	827509T 7	N/A	N/A	N/A	N/A
V-225 (3.0L) Sea Pro/ Marathon	USA 0G245605 - 0G303045	N/A	N/A	N/A	N/A	827509A12	N/A	N/A	N/A	N/A
V-225 (3.0L) Sea Pro/ Marathon	USA 0G303046 - 0T408999	N/A	N/A	N/A	N/A	827509T 7	N/A	N/A	N/A	N/A
V-225 EFI (3.0L)	USA 0G129222 - 0G303045	N/A	N/A	N/A	N/A	827509A12	N/A	N/A	N/A	N/A
V-225 EFI (3.0L)	USA 0G303046 - 0T408999	N/A	N/A	N/A	N/A	827509T 7	N/A	N/A	N/A	N/A
V-225 EFI (3.0L)	USA 0T409000 and up	N/A	N/A	339-8M0077471	N/A	N/A	N/A	N/A	N/A	N/A
V-225 DFI	USA 0G590000 - 1B504988	N/A	N/A	339-856991A 1	N/A	N/A	N/A	N/A	N/A	N/A
V-225 DFI	USA 1B504989 and up	N/A	N/A	339-8M0077473	N/A	N/A	N/A	N/A	N/A	N/A
V-225 Pro XS	USA 1B104549 - 1B426560	N/A	N/A	339-856991A 1	N/A	N/A	N/A	N/A	N/A	N/A
V-225 Pro XS	USA 1B426561 and up	N/A	N/A	339-8M0077471	N/A	N/A	N/A	N/A	N/A	N/A
V-250 EFI (3.0L)	USA 0G129222 - 0T408999	N/A	N/A	N/A	N/A	827509T 7	N/A	N/A	N/A	N/A
V-250 EFI (3.0L)	USA 0T409000 and up	N/A	N/A	339-8M0077471	N/A	N/A	N/A	N/A	N/A	N/A
V-250 (3.4L)	USA 0C101891 and up	N/A	N/A	339-832757A 4	332- 7778A12	N/A	N/A	N/A	N/A	N/A
V-250 DFI	USA 1B528615 and up	N/A	N/A	339-8M0077471	N/A	N/A	N/A	N/A	N/A	N/A
V-250 Pro XS	USA 1B426561 and up	N/A	N/A	339-8M0077471	N/A	N/A	N/A	N/A	N/A	N/A
V-275 (3.4L)	USA 0C101891 and up	N/A	N/A	339-832757A 4	332- 7778A12	N/A	N/A	N/A	N/A	N/A
V-300 XS	USA 1E001867 and up	N/A	N/A	339-8M0077471	N/A	N/A	N/A	N/A	N/A	N/A
V-300 (3.4L)	USA 5611648 and up	N/A	N/A	339-832757A 4	332- 7778A12	N/A	N/A	N/A	N/A	N/A

(1) 5 inch lead

(2) 9 inch lead

(3) Bottom Brush

(4) NLA -No longer available from Mercury, order from Land-N-Sea.

ELECTRICAL SYSTEM

RECTIFIER

RECTIFIER



8M0058226

Supersedes the 816770T
Review the Electronic Parts Catalog for your specific application.

VOLTAGE REGULATORS

VOLTAGE REGULATOR



815279A 2

Kit replaces original louvered regulator 12082A 1.

VOLTAGE REGULATOR KIT

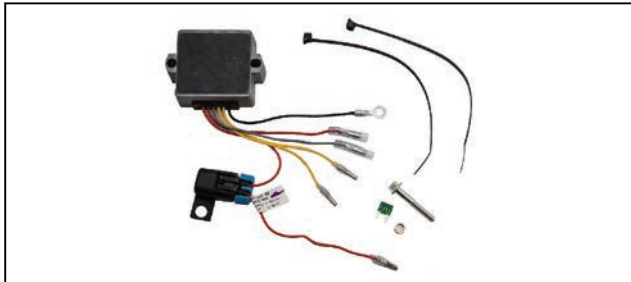

8M0084173

Kit includes a 30 amp mini-fuse with instructions and is used on various 2-cycle outboard engines.
Review the Electronic Parts Catalog for your specific application.

VOLTAGE REGULATOR



18736A21

Fits various V-6 2 stroke outboards. Consult EPC for fitment

VOLTAGE REGULATOR

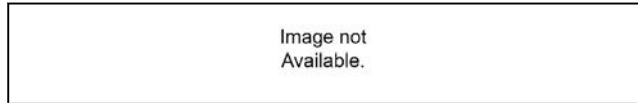

8M0133642

75/90/115 Horsepower 4 stroke, 2B095049 & Up. 65/80 Jet 4 stroke 2B095049 & Up

BATTERY CABLES

BATTERY CABLE KIT



84- 88439A50

Pair of 12 ft.(3.7 m) cables, 1 red (+) Positive and 1 black (-) Negative, 4 gauge with ring terminals. This is an optional accessory kit and may not reflect the original cables on your engine. For original manufactured service part replacement, the Electronic Parts Catalog should always be used for each specific engine. For alternate length cables, consult the appropriate service manual.
Fits Mercury/Mariner outboard engines.

BATTERY CABLE-POS



84- 88439A25

Single 12 ft. positive cable. 4 Gauge with ring terminals.

ELECTRICAL SYSTEM

BATTERY CABLE-NEG



84- 88439A26

Single 12 ft. negative cable. 4 Gauge with ring terminals

STATOR

IGNITION CHARGING COIL



8M0056334

Located under the flywheel, provides the stator charge to the ignition coil. F4/5/6 hp. FourStroke outboards, JPN-0R067090 and above.

IGNITION CHARGING COIL

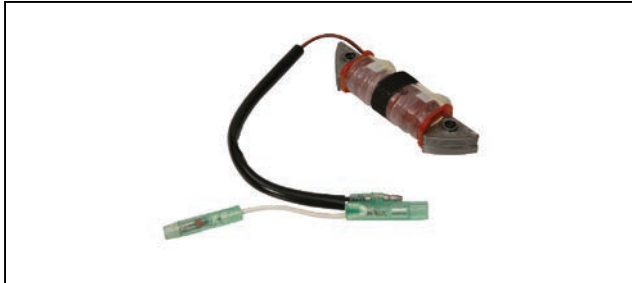

803844T

Located under the flywheel, provides the stator charge to the ignition coil. Fits the F4/5/6 hp. FourStroke outboards, JPN-0R000001-0R067089, BEL-0P073456-0P400999.

IGNITION CHARGING COIL



803844T01

Located under the flywheel, provides the stator charge to the ignition coil. 8/9.9 hp. FourStroke outboards, beginning with Model Year 2005.

IGNITION STATOR ASSEMBLY



86617A20

Used on various 6-25 Hp. 2-cycle outboards. Review the Electronic Parts Catalog for your specific application.

IGNITION STATOR ASSEMBLY



855721T 8

See application chart

IGNITION STATOR ASSEMBLY



86617A17

See application chart

IGNITION STATOR ASSEMBLY



398- 852386T 8

See application chart

IGNITION STATOR ASSEMBLY**398-852387T 9**

See application chart

IGNITION STATOR ASSEMBLY**398-5255**

See application chart

IGNITION STATOR ASSEMBLY**86704A10**

See application chart

IGNITION STATOR ASSEMBLY**398-5704A 7**

See application chart

IGNITION STATOR KIT**398-832075A20**

Fits 45/50 Hp. 4 cylinder 2-cycle outboards, replacing 832075A14 and 5454A25. Review the Electronic Parts Catalog for your specific application.

IGNITION STATOR KIT**398-832075A 9**

See application chart

IGNITION STATOR KIT**398-832075A15**

See application chart

IGNITION STATOR ASSEMBLY**398-832075A21**

Fits various 30-125 Hp. 2-cycle outboards. Review the Electronic Parts Catalog for your specific application.

ELECTRICAL SYSTEM

MERCURY® OUTBOARDS

IGNITION STATOR KIT



835399T

See application chart

IGNITION STATOR KIT



398-825089 1

See application chart

IGNITION STATOR KIT



398-804262T

See application chart

IGNITION STATOR KIT



76314A 3

See application chart

IGNITION STATOR KIT



398-832074A11

See application chart

IGNITION STATOR KIT

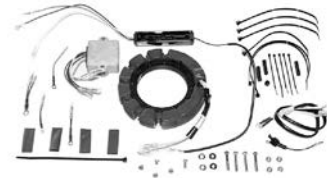

398-9873A38

See application chart

IGNITION STATOR KIT

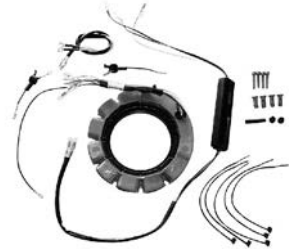

398-832074A 6

See application chart

IGNITION STATOR KIT



398-832075A19

See application chart

IGNITION STATOR KIT



398-832075A 5

Replaces 9873A35 and 9710A47.
Review the Electronic Parts Catalog for your specific application.

IGNITION STATOR KIT



398-832075A 7

See application chart

IGNITION STATOR KIT

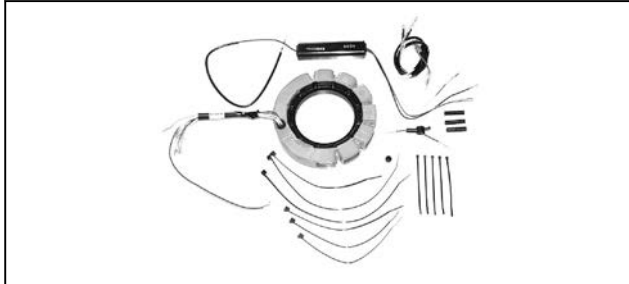

398-832074A 4

See application chart

IGNITION STATOR KIT



398-832075A 6

See application chart

IGNITION STATOR KIT



398-832075A 8

See application chart

IGNITION STATOR ASSEMBLY



398-5454A26

See application chart

IGNITION STATOR ASSEMBLY



398-852386T 6

See application chart

IGNITION STATOR ASSEMBLY



398-852386T 8

See application chart

IGNITION STATOR ASSEMBLY



398-852387T 9

See application chart

IGNITION STATOR ASSEMBLY



398-4793

See application chart

IGNITION STATOR ASSEMBLY



398-5454A17

See application chart

IGNITION STATOR ASSEMBLY



398-9610A19

Used on various V-6 2-cycle outboards.
Review the Electronic Parts Catalog for your specific application.

IGNITION STATOR ASSEMBLY



398-5454A35

See application chart

IGNITION STATOR ASSEMBLY



398-9610A 5

See application chart

IGNITION STATOR ASSEMBLY



398-5454A 7

See application chart

IGNITION STATOR ASSEMBLY



398-5454A32

See application chart

IGNITION STATOR ASSEMBLY



398-821935A 5

Fits V-6, 225/250/Race 300, Carb and EFI, 3.0L 2-cycle outboards.
Review the Electronic Parts Catalog for your specific application.

IGNITION STATOR ASSEMBLY



398-878143T05

See application chart

IGNITION STATOR ASSEMBLY



398-881336T 2

See application chart

IGNITION STATOR ASSEMBLY



398-858404T 4

Fits various V-6, carbureted 2-cycle outboards.
Review the Electronic Parts Catalog for your specific application.

IGNITION STATOR ASSEMBLY



898101T01

See application chart

STATOR



300-8M0088059

Fits the F75-115 (2.1L) FourStroke outboard beginning with serial number USA 2B095049 and up.

IGNITION STATOR ASSEMBLY

Image not Available.

8M0134470

15/20 EFI FourStroke outboard, 0R833820 and above.
Quicksilver Branded

ELECTRICAL SYSTEM

MERCURY® OUTBOARDS

STATOR APPLICATION CHART - MERCURY/MARINER

Mercury/Mariner Ignition Stators

Model	Model Note		Serial # Range	Standard Stator	OPTIONAL Stator CONVERTS 9 AMP TO 16 AMP
2.5 FourStroke		JPN	0R131842 and up	N/A	N/A
3.5 FourStroke		JPN	0R131842 and up	N/A	N/A
4 FourStroke	Ignition Charging Coil	JPN	0R000001 - 0R067089	803844T	N/A
		BEL	0P073456 - 0P400999		
4 FourStroke	Ignition Charging Coil	JPN	0R067090 and up	8M0056334	N/A
		BEL	0P401000 and up		
5 FourStroke	Ignition Charging Coil	JPN	0R000001 - 0R067089	803844T	N/A
		BEL	0P073456 - 0P400999		
5 FourStroke	Ignition Charging Coil	JPN	0R067090 and up	8M0056334	N/A
		BEL	0P401000 and up		
6 FourStroke	Ignition Charging Coil	JPN	0R000001 - 0R067089	803844T	N/A
		BEL	0P073456 - 0P400999		
6 FourStroke	Ignition Charging Coil	JPN	0R067090 and up	8M0056334	N/A
		BEL	0P401000 and up		
6		USA	0A197112 - 0G760299	86617A20	N/A
		BEL	9461526 - 0P016999		
6		USA	0G760300 - 0T800749	855721T 8	N/A
		BEL	0P017000 and up		
7.5 (75)			2810637 - 3274632	N.L.A.	N/A
7.5 (7.5, 75)		USA	3801458 and up	N.L.A.	N/A
		AUS	8015315 and up		
		BEL	9068874 and up		
		CAN	7043133 and up		
8		USA	0A197112 - 0G760299	86617A20	N/A
		BEL	9461526 - 0P016999		
8		USA	0G760300 and up	855721T 8	N/A
		BEL	0P017000 and up		
8 FourStroke, Manual Models	232cc	USA	0H000058 - 0H017349	N.L.A.	N/A
8 FourStroke, Manual Models	232cc	USA	0G760300 - 0T178499	N.L.A.	N/A
8 FourStroke	323cc with capacitor charging coil.	BEL	0P086824 - 0P325499	835399T	N/A
8 FourStroke	209cc, Ignition Charging Coil	JPN	0R042475 and up	803844T01	N/A
		BEL	0P325500 and up		
9.8 (110)			2798057 - 3263262	N.L.A.	N/A
9.8 (9.8, 110)		USA	3795658 and up	N.L.A.	N/A
		AUS	8015040 and up		
		BEL	9041439 and up		
		CAN	7027323 and up		
9.9		USA	0A197112 - 0G760299	86617A20	N/A
		BEL	9461526 - 0P016999		
9.9		USA	0G760300 and up	855721T 8	N/A
		BEL	0P017000 and up		
9.9 FourStroke (Manual Models)	232cc	USA	0H000058 - 0H016909	N.L.A.	N/A
9.9 FourStroke (Manual Models)	323cc with capacitor charging coil.	USA	0G760300 - 1B226999	835399T	N/A
9.9 FourStroke (Electric Models)	232cc	USA	0H000058 - 0H016909	N.L.A.	N/A
9.9 FourStroke (Electric Models)	323cc with capacitor charging coil.	USA	0G760300 - 0T979999	835399T	N/A
		BEL	0P075166 - 0P400999		
9.9 FourStroke	Ignition Charging Coil	JPN	0R042475 and up	803844T01	N/A
		BEL	0P325500 and up		

Model	Model Note		Serial # Range	Standard Stator	OPTIONAL Stator CONVERTS 9 AMP TO 16 AMP
15		USA	0B292414 - 0G760299	86617A20	N/A
		BEL	9542620 - 0P016999		
15		USA	0G760300 and up	855721T 8	N/A
		BEL	0P017000 and up		
15 FourStroke (Manual Models)	323cc with capacitor charging coil.	USA	0G590000 - 1B727495	835399T	N/A
15 FourStroke (Electric Models)	323cc with capacitor charging coil.	USA	0G590000 - 1B727495	835399T	N/A
15 FourStroke	351cc	JPN	0R235949 - 0R833819	879147T69	N/A
15 EFI FourStroke		JPN	0R833820 and up	8M0134477	
18 (18, 18XD)		USA	5837437 and up	86617A20	N/A
		AUS	8071973 and up		
		BEL	9308306 and up		
		CAN	7173723 and up		
20 (200)			2827677 - 3226957	N.L.A.	N/A
20 (20, 200)		USA	4403783 - 6443972	N.L.A.	N/A
		AUS	8039075 and up		
		BEL	9122765 - 9415100		
		CAN	7077248 - 7209532		
20 (20, 20XD)		USA	6443973 - 0G044026	86617A20	N/A
		BEL	9415101 - 9807908		
		CAN	7209533 and up		
20		USA	0G044027 - 0G437999	86617A17	N/A
		BEL	9807909 - 9926999		
20		USA	0G438000 - 0G760299	86617A20	N/A
		BEL	9972700 - 0P016999		
20		USA	0G760300 - 0T800999	855721T 8	N/A
		BEL	0P017000 and up		
20 FourStroke		JPN	0R235168 - 0R833819	879147T69	N/A
20 JET		USA	0G044027 - 0G437999	86617A17	N/A
		BEL	9807909 - 9926999		
20 JET		USA	0G438000 - 0G760299	86617A20	N/A
		BEL	9972700 - 0P016999		
20 JET		USA	0G760300 and up	855721T 8	N/A
		BEL	0P017000 and up		
20 EFI FourStroke		JPN	0R833820 and up	8M0134470	
25 (25, 25XD)		USA	5705532 - 0G044026	86617A20	N/A
		AUS	8073158 and up		
		BEL	9315316 - 9807908		
		CAN	7166928 and up		
25 (2 cyl)		USA	0G044027 - 0G437999	86617A17	N/A
		BEL	9807909 - 9926999		
25 (2 cyl)		USA	0G438000 - 0G760299	86617A20	N/A
		BEL	9972700 - 0P016999		
25 (2 cyl)		USA	0G760300 and up	855721T 8	N/A
		BEL	0P017000 and up		
25 FourStroke	Manual Models	USA	0G590000 - 0G960499	398-852386T 8	N/A
		BEL	9973100 - 0P058999		
25 FourStroke	Electric Models	USA	0G590000 - 0G960499	398-852387T 9	N/A
		BEL	9973100 - 0P058999		
25 FourStroke, Carb Models	Manual start	USA	0G960500 - 1B344298	398-852386T 6	N/A
		BEL	0P059000 - 0P388282		
25 FourStroke, Carb Models	Electric start	USA	0G960500 - 1B344298	NLA	N/A
		BEL	0P059000 - 0P388282		
25 FourStroke	EFI	JPN	0R016999 and up	898101T01	N/A
25 JET, FourStroke	EFI	JPN	0R165086 and up	898101T01	N/A

Not all parts listed are available for the European, C.I.S., Africa and Middle East Markets.
For more information, please contact your local Mercury, Mariner, MerCruiser or Quicksilver Office.

ELECTRICAL SYSTEM

MERCURY® OUTBOARDS

Model	Model Note		Serial # Range	Standard Stator	OPTIONAL Stator CONVERTS 9 AMP TO 16 AMP
30 JET (4 cyl)(Electric Models)		USA	0C159200 - 0D055047	398-832075A20	N/A
		BEL	9570790 - 9665164		
30 JET (4 cyl)(Electric Models)	With stator stamped 818535A3 or A13	USA	0D055048 - 0G589999	398-832075A20	N/A
30 JET (4 cyl)(Electric Models)	With Voltage Regulator	USA	0D055048 - 0G589999	398-832075A 9	N/A
30 JET (4 cyl)(Electric Models)	Without Voltage Regulator	USA	0D055048 - 0G589999	398-832075A20	398-832075A15
30 JET (3 cyl)(Electric Models)		USA	0G590000 - 0T408999	398-832075A21	N/A
30 (2 cyl)(644cc)	Manual Models	USA	0G053314 and up	398-832074A11	N/A
30 (2 cyl)(644cc)	Electric Models	USA	0G053314 and up	398-832075A21	N/A
30 (4-Stroke)(3 cyl) Carb	Manual Models	USA	0G760300 - 0G960499	398-852386T 8	N/A
30 (4-Stroke)(3 cyl) Carb	Electric Models	USA	0G760300 - 0G960499	398-852387T 9	N/A
30 (4-Stroke)(3 cyl) Carb	Manual Models	USA	0G960500 - 1B226999	398-852386T 6	N/A
		BEL	0P153500 - 0P400999		
30 (4-Stroke)(3 cyl) Carb	Electric Models	USA	0G960500 - 1B226999	NLA	N/A
		BEL	0P153500 - 0P400999		
30 FourStroke (3 cyl)	EFI	USA	0G409000 - 1B226999	398-878143T05	N/A
		BEL	0P153500 - 0P400999		
30 FourStroke	EFI	JPN	0R016999 and up	898101T01	N/A
35 (2 cyl)		USA	6445653 - 0B110788	86617A20	N/A
		BEL	9384476 and up		
		CAN	7209608 and up		
40 (40, 402)(2 cyl)(Electric Models)		USA	3859435 - 5823917	398- 5255	N/A
		AUS	8016690 - 8070639		
		BEL	9051459 - 9298955		
		CAN	7032138 - 7169337		
40 (2 cyl)(Electric Models)		USA	5823918 - 0G053313	86704A10	N/A
		AUS	8070640 and up		
		BEL	9298956 and up		
		CAN	7169338 and up		
40 (2 cyl)(644cc)	Manual Models	USA	0G053314 and up	398-832074A11	N/A
40 (2 cyl)(644cc)	Electric Models	USA	0G053314 and up	398-832075A21	N/A
40 (3 cyl)	Electric Models	USA	0G590000 - 0T999999	398-832075A21	N/A
		BEL	0P017000 - 0P325499		
40 (3 cyl)	Manual Models	USA	0G590000 - 0T999999	398-832074A11	N/A
		BEL	0P017000 - 0P325499		
40 (4 cyl)	Manual Models	USA	0C159200 and up	398-832074A 6	N/A
		BEL	9570790 and up		
40 (4 cyl)	Electric Models	USA	0C159200 - 0D055047	398-832075A20	N/A
		BEL	9570790 - 9665164		
40 (4 cyl)(Electric Models)	With stator stamped 818535A3 or A13	USA	0D055048 and up	398-832075A20	N/A
		BEL	9665165 and up		
40 (4 cyl)(Electric Models)	With Voltage Regulator	USA	0D055048 and up	398-832075A 9	N/A
		BEL	9665165 and up		
40 (4 cyl)(Electric Models)	Without Voltage Regulator	USA	0D055048 and up	398-832075A20	398-832075A15
		BEL	9665165 and up		
40 FourStroke (3 cyl) Carb	Manual Models	USA	0G760300 - 0G960499	398-852386T 8	N/A
40 FourStroke (3 cyl) Carb	Electrical Models	USA	0G760300 - 0G960499	398-852387T 9	N/A
40 FourStroke (3 cyl) Carb	Manual Models	USA	0G960500 - 1B226999	398-852386T 6	N/A
		BEL	0P153500 - 0P400999		
40 FourStroke (3 cyl) Carb	Electric Models	USA	0G960500 - 1B226999	NLA	N/A
		BEL	0P153500 - 0P400999		
40 FourStroke	3 cylinder, Carb	USA	1B227000 - 1B344306	398-852386T 6	N/A
		BEL	0P401000 and up		
		CHN	1C000001 and up		

Model	Model Note		Serial # Range	Standard Stator	OPTIONAL Stator CONVERTS 9 AMP TO 16 AMP
40 FourStroke	3 cylinder, EFI	USA	0G409000 - 1B344398	398- 878143T05	N/A
		BEL	0P153500 - 0P515896		
		CHN	1C000001 and up		
40 FourStroke	4 cylinder, 935cc	USA	0G231123 - 0G760299	398- 825089 1	N/A
40 FourStroke	4 cylinder, Carb, 996cc	USA	0T228405 - 0T598999	NLA	N/A
		BEL	0P094500 - 0P206999		
40 FourStroke	4 cylinder, EFI, 996cc	USA	0T409000 - 1B344306	398- 878143T05	N/A
		BEL	0P151500 and up		
		CHN	1C000001 and up		
40 JET, FourStroke	4 cylinder	CHN	1C051324 and up	398- 878143T05	N/A
45 (4 cyl)	Manual Models	USA	5531630 - 0B110788	76314A 3	N/A
		AUS	8063985 and up		
		BEL	9248006 - 9466691		
		CAN	7143688 - 0A719280		
45 (4 cyl)	Electric Models	USA	5531630 - 0B110788	398- 832075A20	N/A
		AUS	8063985 and up		
		BEL	9248006 - 9466691		
		CAN	7143688 - 0A719280		
45 (4 cyl)	Manual Models	USA	0B110789 and up	398- 832074A 6	N/A
		BEL	9466692 and up		
		CAN	0A719281 and up		
45 (4 cyl)	Electric Models	USA	0B110789 and up	398- 832075A20	N/A
		BEL	9466692 and up		
		CAN	0A719281 and up		
45 FourStroke		USA	0G231123 - 0T178499	398- 825089 1	N/A
		BEL	0P017000 - 0P016999		
50 (500)(4 cyl)		USA	2858814 - 4357639	N.L.A.	N/A
		AUS	2863739 - 8030089		
		BEL	9001581 - 9107213		
		CAN	2742142 - 7068997		
50 (500)(4 cyl)	Manual Models	USA	4357640 and up	76314A 3	N/A
		AUS	8030090 and up		
		BEL	9107214 and up		
		CAN	7068998 and up		
50 (500)(4 cyl)	Electric Models	USA	4357640 and up	398- 832075A20	N/A
		AUS	8030090 and up		
		BEL	9107214 and up		
		CAN	7068998 and up		
50 (3 cyl)		USA	6428681 - 0D000749	398- 5704A 7	N/A
		BEL	9385911 - 9683054		
		CAN	7208333 and up		
50 (3 cyl)	With stator stamped 9710A22	USA	0D000750 - 0G290584	398- 9873A38	N/A
		BEL	9683055 - 9885344		
50 (3 cyl)	With stator stamped 9710A34	USA	0D000750 - 0G290584	398- 832075A19	N/A
		BEL	9683055 - 9885344		
50 (3 cyl)	With stator stamped 9710A23	USA	0D000750 - 0G290584	398- 832075A 5	N/A
		BEL	9683055 - 9885344		
50 (3 cyl)		USA	0G290585 - 0G589999	398- 832075A 5	N/A
		BEL	9885345 - 9973099		
50 (3 cyl)	Manual Models	USA	0G590000 - 0T999999	398- 832074A11	N/A
		BEL	9973100 and up		
50 (3 cyl)	Electric Models	USA	0G590000 - 0T999999	398- 832075A21	N/A
		BEL	9973100 and up		

Not all parts listed are available for the European, C.I.S., Africa and Middle East Markets.
For more information, please contact your local Mercury, Mariner, MerCruiser or Quicksilver Office.

ELECTRICAL SYSTEM

MERCURY® OUTBOARDS

Model	Model Note		Serial # Range	Standard Stator	OPTIONAL Stator CONVERTS 9 AMP TO 16 AMP
50 FourStroke	935 cc	USA	0G231123 - 0T178499	398-825089 1	N/A
50 FourStroke, Carb	996 cc	USA	0T178500 - 0T598999	NLA	N/A
		BEL	0P094500 - 0P206999		
50 FourStroke (4 cyl) EFI	996 cc	USA	0T409000 and up	398-878143T05	N/A
		BEL	0P153500 and up		
		CHN	1C000001 and up		
55 (3 cyl)		USA	0D000750 - 0G589999	398-832075A21	N/A
		BEL	9741042 - 9973099		
55 (3 cyl)	Manual Models	USA	0G590000 and up	398-832074A11	N/A
		BEL	9973100 and up		
55 (3 cyl)	Electric Models	USA	0G590000 and up	398-832075A21	N/A
		BEL	9973100 and up		
60 (3 cyl)		USA	6428681 - 0D000749	398-5704A 7	N/A
		BEL	9385911 - 9683054		
		CAN	7208333 and up		
60 (3 cyl)	With stator stamped 9710A22	USA	0D000750 - 0G290584	398-9873A38	N/A
		BEL	9683055 - 9885344		
60 (3 cyl)	With stator stamped 9710A34	USA	0D000750 - 0G290584	398-832075A19	N/A
		BEL	9683055 - 9885344		
60 (3 cyl)	With stator stamped 9710A23	USA	0D000750 - 0G290584	398-832075A 5	N/A
		BEL	9683055 - 9885344		
60 (3 cyl)		USA	0G290585 - 0G589999	398-832075A 5	N/A
		BEL	9885345 - 9973099		
60 (3 cyl)	Manual Models	USA	0G590000 and up	398-832074A11	N/A
		BEL	9973100 and up		
60 (3 cyl)	Electric Models	USA	0G590000 and up	398-832075A21	N/A
		BEL	9973100 and up		
60 FourStroke	Carb	USA	0T178500 - 0T598999	NLA	N/A
		BEL	0P094500 - 0P206999		
60 FourStroke	EFI	USA	0T409000 and up	398-878143T05	N/A
		BEL	0P153500 and up		
		CHN	1C000001 and up		
65 (650)(3cyl)		USA	4382057 - 4571651	398-5704A 7	N/A
		BEL	9112989 - 9135824		
		CAN	7073473 - 7087822		
65 JET (Electric)	With voltage regulator.	USA	0D283222 - 0G437999	398-832075A 5	N/A
65 JET (Electric)	Without voltage regulator.(1)	USA	0D283222 - 0G437999	398-832075A19	398-832075A 7
70 (3 cyl)		USA	4571652 - 0A996141	398-5704A 7	N/A
		AUS	8042350 and up		
		BEL	9135825 - 9483120		
		CAN	7087823 - 7208332		
70 (3 cyl)	With voltage regulator.	USA	0A996142 - 0B240450	398-832075A 5	N/A
		BEL	9483121 - 9506480		
70 (3 cyl)	Without voltage regulator.(1)	USA	0A996142 - 0B240450	398-832075A19	398-832075A 7
		BEL	9483121 - 9506480		
70 (3 cyl)	With stator stamped 9710A14.	USA	0B240451 - 0C221999	398-832075A 5	N/A
		BEL	9506481 - 9589038		
70 (3 cyl)	w/stator stamped 8778A16 & regulator	USA	0B240451 - 0C221999	398-832075A 5	N/A
		BEL	9506481 - 9589038		
70 (3 cyl)	w/stator stamped 8778A16 & no regulator.(1)	USA	0B240451 - 0C221999	N/A	398-832075A 7
		BEL	9506481 - 958038		

Model	Model Note		Serial # Range	Standard Stator	OPTIONAL Stator CONVERTS 9 AMP TO 16 AMP
75 (4 cyl)		USA	6432901 and up	398- 5454A26	N/A
		BEL	9393856 and up		
		CAN	7208573 and up		
75 (3 cyl)		USA	0C222000 - 0D283221	398- 832075A 5	N/A
		BEL	9589039 - 9793576		
75 (3 cyl)(Manual Models)		USA	0D283222 - 0G437999	398- 832074A 4	N/A
		BEL	9793577 - 9926999		
75 (3 cyl)(Electric Models)	With voltage regulator.	USA	0D283222 - 0G437999	398- 832075A 5	N/A
		BEL	9793577 - 9926999		
75 (3 cyl)(Electric Models)	Without voltage regulator.(1)	USA	0D283222 - 0G437999	398- 832075A19	398- 832075A 7
		BEL	9793577 - 9926999		
75 (3 cyl)	Manual Models	USA	0G438000 and up	398- 832074A11	N/A
		BEL	9927000 and up		
75 (3 cyl)	Electric Models	USA	0G438000 and up	398- 832075A21	N/A
		BEL	9927000 and up		
75 FourStroke	1596cc, Carb Models	USA	0G960500 - 1B226999	398- 804262T	N/A
75 FourStroke	1596cc, EFI Models	USA	1B172291 - 1B366822	398- 881336A03	N/A
75 FourStroke	2.1L	USA	2B095049 and up	300- 8M0088059	N/A
80 (80, 800)(4 cyl)		USA	4831999 - 6432900	398- 5454A26	N/A
		AUS	8050200 and up		
		BEL	9177626 - 9393855		
		CAN	7110998 - 7208572		
80 (3 cyl)	With voltage regulator.	USA	0A996142 - 0B240450	398- 832075A 5	N/A
		BEL	9483121 - 9506480		
80 (3 cyl)	Without voltage regulator.(1)	USA	0A996142 - 0B240450	398- 832075A19	398- 832075A 7
		BEL	9483121 - 9506480		
80 (3 cyl)	With stator stamped 9710A14.	USA	0B240451 and up	398- 832075A 5	N/A
		BEL	9506481 and up		
80 (3 cyl)	w/stator stamped 8778A16 & regulator	USA	0B240451 and up	398- 832075A 5	N/A
		BEL	9506481 and up		
80 (3 cyl)	w/stator stamped 8778A16 & no regulator.(1)	USA	0B240451 and up	N/A	398- 832075A 7
		BEL	9506481 and up		
80 JET	With voltage regulator.	USA	0D283222 - 0G437999	398- 832075A 6	N/A
80 JET	Without voltage regulator.	USA	0D283222 - 0G437999	398- 832075A 8	N/A
80 JET		USA	0G438000 and up	398- 832075A21	N/A
80 FourStroke	2.1L	USA	2B095049 and up	300- 8M0088059	N/A
85 (850)(4 cyl)		USA	4366802 - 4831998	398- 5454A26	N/A
		AUS	8043775 - 8050199		
		BEL	9110014 - 9177625		
		CAN	7071373 - 7110997		
90 (90, 900)(6 cyl)		USA	4845301 - 5299505	398- 4793	N/A
		CAN	711698 - 7123762		
90 (6 cyl)		USA	5299506 and up	398- 5454A17	N/A
		AUS	8060545 and up		
		CAN	7147088 and up		
90 (3 cyl)	With voltage regulator.	USA	0A996142 - 0B240450	398- 832075A 5	N/A
		BEL	9483121 - 9506480		
90 (3 cyl)	Without voltage regulator.(1)	USA	0A996142 - 0B240450	398- 832075A19	398- 832075A 7
		BEL	9483121 - 9506480		
90 (3 cyl)	With stator stamped 9710A14.	USA	0B240451 and up	398- 832075A 5	N/A
		BEL	9506481 and up		

ELECTRICAL SYSTEM

MERCURY® OUTBOARDS

Model	Model Note	Serial # Range	Standard Stator	OPTIONAL Stator CONVERTS 9 AMP TO 16 AMP
90 (3 cyl)	w/stator stamped 8778A16 & regulator	USA BEL 0B240451 and up 9506481 and up	398-832075A 5	N/A
90 (3 cyl)	w/stator stamped 8778A16 & no regulator.(1)	USA BEL 0B240451 and up 9506481 and up	N/A	398-832075A 7
90 (3 cyl)		USA BEL 0C222000 - 0D283221 9589039 - 9793576	398-832075A 5	N/A
90 (3 cyl)(Manual Models)		USA BEL 0D283222 - 0G437999 9793577 - 9926999	398-832074A 4	N/A
90 (3 cyl)(Electric Models)	With voltage regulator.	USA BEL 0D283222 - 0G437999 9793577 - 9926999	398-832075A 5	N/A
90 (3 cyl)(Electric Models)	Without voltage regulator.(1)	USA BEL 0D283222 - 0G437999 9793577 - 9926999	398-832075A19	398-832075A 7
90 (3 cyl)	Manual Models	USA BEL 0G438000 and up 9927000 and up	398-832074A11	N/A
90 (3 cyl)	Electric Models	USA BEL 0G438000 and up 9927000 and up	398-832075A21	N/A
90 FourStroke	1596cc, Carb Models	USA 0G960500 - 1B226999	398-804262T	N/A
90 FourStroke	1596cc, EFI Models	USA 1B172291 - 1B366822	398-881336A03	N/A
90 FourStroke	2.1L	USA 2B094049 and up	300-8M0088059	N/A
100 (4 cyl)	With voltage regulator.	USA BEL 0B209468 - 0D283221 9523034 - 9793576	398-832075A 6	N/A
100 (4 cyl)	Without voltage regulator.	USA BEL 0B209468 - 0D283221 9523034 - 9793576	398-832075A 8	N/A
100 (4 cyl)	With voltage regulator.	USA BEL 0D283222 - 0G437999 9793577 - 9926999	398-832075A 6	N/A
100 (4 cyl)	Without voltage regulator.	USA BEL 0D283222 - 0G437999 9793577 - 9926999	398-832075A 8	N/A
100 (4 cyl)		USA BEL 0G438000 and up 9927000 and up	398-832075A21	N/A
100 FourStroke	2.1L	USA 2B095049 and up	300-8M0088059	N/A
115 (115, 1150)(6 cyl)		USA AUS CAN 4855153 - 5314655 8051950 - 8061119 7112248 - 7131212	398- 4793	N/A
115 (115, 1150)(6 cyl)		USA AUS CAN 5314656 and up 8061120 and up 7131213 and up	398- 5454A17	N/A
115 (4 cyl)	With voltage regulator.	USA BEL 0C10000 - 0D283221 9559771 - 9793576	398-832075A 6	N/A
115 (4 cyl)	Without voltage regulator.	USA BEL 0C10000 - 0D283221 9559771 - 9793576	398-832075A 8	N/A
115 (4 cyl)	With voltage regulator.	USA BEL 0D283222 - 0G437999 9793577 - 9926999	398-832075A 6	N/A
115 (4 cyl)	Without voltage regulator.	USA BEL 0D283222 - 0G437999 9793577 - 9926999	398-832075A 8	N/A
115 (4 cyl)		USA BEL 0G438000 and up 9927000 and up	398-832075A21	N/A
115 FourStroke EFI	1741cc	USA 0T178500 - 1B366822	398-881336T 2	N/A
115 FourStroke	2.1L	USA 2B095049 and up	300-8M0088059	N/A
125 (4 cyl)	With voltage regulator.	USA BEL 0D283222 - 0G437999 9793577 - 9926999	398-832075A 6	N/A
125 (4 cyl)	Without voltage regulator.	USA BEL 0D283222 - 0G437999 9793577 - 9926999	398-832075A 8	N/A

Model	Model Note		Serial # Range	Standard Stator	OPTIONAL Stator CONVERTS 9 AMP TO 16 AMP
125 (4 cyl)		USA	0G438000 and up	398- 832075A21	N/A
		BEL	9927000 and up		
140 (140, 1400)(6 cyl)		USA	4865678 - 5327662	398- 4793	N/A
		AUS	8052650 - 8052879		
		CAN	7112773 - 7132512		
140 (6 cyl)		USA	5327663 and up	398- 5454A17	N/A
		CAN	7132513 and up		
V-105 JET		USA	0D082000 - 0G960499	398- 9610A19	N/A
V-135 Carbed	w/ 1/2 inch laminations on stator.	USA	0A904646 - 0C100860	398- 5454A32	N/A
V-135 Carbed	w/ 5/8 inch laminations on stator.	USA	0A904646 - 0C100860	398- 5454A35	N/A
V-135 Carbed		USA	0C100861 - 0C239552	398- 9610A 5	N/A
V-135 Carbed	Black 16 amp stator w/ non-louvred cover & coated stator wires	USA	0C239553 - 0D081999	398- 5454A35	N/A
V-135 Carbed	Black 16 amp stator w/ louvred cover & coated stator wires	USA	0C239553 - 0D081999		N/A
V-135 Carbed	Clear 40 amp stator w/ louvred cover & visible stator wires	USA	0C239553 - 0D081999	398- 9610A 5	N/A
V-135 Carbed		USA	0D082000 - 0G960499	398- 9610A19	N/A
V-135 Carbed		USA	0G960500 - 0T178499	398- 858404T 4	N/A
V-140 JET		USA	0D082000 - 0G960499	398- 9610A19	N/A
V-150 Carbed		USA	4868998 - 0A904645	398- 5454A 7	N/A
V-150 Carbed	w/ 1/2 inch laminations on stator.	USA	0A904646 - 0C100860	398- 5454A32	N/A
V-150 Carbed	w/ 5/8 inch laminations on stator.	USA	0A904646 - 0C100860	398- 5454A35	N/A
V-150 Carbed		USA	0C100861 - 0C239552	398- 9610A 5	N/A
V-150 Carbed	Black 16 amp stator w/ non-louvred cover & coated stator wires	USA	0C239553 - 0D081999	398- 5454A35	N/A
V-150 Carbed	Black 16 amp stator w/ louvred cover & coated stator wires	USA	0C239553 - 0D081999		N/A
V-150 Carbed	Clear 40 amp stator w/ louvred cover & visible stator wires	USA	0C239553 - 0D081999	398- 9610A 5	N/A
V-150 Carbed		USA	0D082000 - 0G960499	398- 9610A19	N/A
V-150 Carbed		USA	0G960500 and up	398- 858404T 4	N/A
V-150 EFI		USA	0D082000 - 0G960499	398- 9610A19	N/A
V-150 EFI		USA	0G960500 - 0T408999	398- 858404T 4	N/A
V-150 XR4, Magnum II		USA	0B242885 - 0C100860	398- 5454A35	N/A
V-150 XR4, Magnum II		USA	0C100861 - 0C239552	398- 9610A 5	N/A
V-150 XR4, Magnum II	Black 16 amp stator w/ non-louvred cover & coated stator wires	USA	0C239553 - 0D081999	398- 5454A35	N/A
V-150 XR4, Magnum II	Black 16 amp stator w/ louvred cover & coated stator wires	USA	0C239553 - 0D081999		N/A
V-150 XR4, Magnum II	Clear 40 amp stator w/ louvred cover & visible stator wires	USA	0C239553 - 0D081999	398- 9610A 5	N/A
V-150 XR6, Magnum III		USA	0D082000 - 0G960499	398- 9610A19	N/A
V-150 XR6, Magnum III		USA	0G960500 and up	398- 858404T 4	N/A
V-175 (175, 1750) Carbed		USA	4301235 - 6618750	398- 5454A 7	N/A
		AUS	8058870 and up		
V-175 Carbed	Without voltage regulator.	USA	6618751 - 0C100860	398- 5454A 7	N/A
V-175 Carbed	With voltage regulator and 1/2 inch stator laminations	USA	6618751 - 0C100860	398- 5454A32	N/A
V-175 Carbed	With voltage regulator and 5/8 inch stator laminations	USA	6618751 - 0C100860	398- 5454A35	N/A
V-175 Carbed		USA	0C100861 - 0C239552	398- 9610A 5	N/A
V-175 Carbed	Black 16 amp stator w/ non-louvred cover & coated stator wires	USA	0C239553 - 0D081999	398- 5454A35	N/A
V-175 Carbed	Black 16 amp stator w/ louvred cover & coated stator wires	USA	0C239553 - 0D081999		N/A
V-175 Carbed	Clear 40 amp stator w/ louvred cover & visible stator wires	USA	0C239553 - 0D081999	398- 9610A 5	N/A
V-175 Carbed		USA	0D082000 - 0G960499	398- 9610A19	N/A

Not all parts listed are available for the European, C.I.S., Africa and Middle East Markets.
For more information, please contact your local Mercury, Mariner, MerCruiser or Quicksilver Office.

ELECTRICAL SYSTEM

MERCURY® OUTBOARDS

Model	Model Note	Serial # Range	Standard Stator	OPTIONAL Stator CONVERTS 9 AMP TO 16 AMP
V-175 EFI		USA 0D000749 - 0D081999	398- 9610A 5	N/A
V-175 EFI		USA 0D082000 - 0G960499	398- 9610A19	N/A
V-175 EFI		USA 0G960500 - 0T408999	398- 858404T 4	N/A
V-200 (200, 2000) Carbed		USA 4839034 - 6625220	398- 5454A 7	N/A
		AUS 8061595 - 8065672		
V-200 Carbed	Without voltage regulator.	USA 6618751 - 0C100860	398- 5454A 7	N/A
V-200 Carbed	With voltage regulator and 1/2 inch stator laminations	USA 6618751 - 0C100860	398- 5454A32	N/A
V-200 Carbed	With voltage regulator and 5/8 inch stator laminations	USA 6618751 - 0C100860	398- 5454A35	N/A
V-200 Carbed	Black 16 amp stator w/ non-louved cover & coated stator wires	USA 0C100861 - 0C291519	398- 5454A35	N/A
V-200 Carbed	Clear 40 amp stator w/ louvred cover & visible stator wires	USA 0C100861 - 0C291519	398- 9610A 5	N/A
V-200 Carbed	Black 16 amp stator w/ non-louved cover & coated stator wires	USA 0C291520 - 0D081999	398- 5454A35	N/A
V-200 Carbed	Black 16 amp stator w/ louvred cover & coated stator wires	USA 0C291520 - 0D081999		N/A
V-200 Carbed	Clear 40 amp stator w/ louvred cover & visible stator wires	USA 0C291520 - 0D081999	398- 9610A 5	N/A
V-200 Carbed		USA 0D082000 - 0G960499	398- 9610A19	N/A
V-200 EFI		USA 0C100861 - 0D081999	398- 9610A 5	N/A
V-200 EFI		USA 0D082000 - 0G960499	398- 9610A19	N/A
V-200 EFI (2.5L)		USA 0G960500 - 0T408999	398- 858404T 4	N/A
V-220 Laser		USA 0B117316 and up	398- 5454A35	N/A
V-225 Carbed (2.4L)		USA 5628028 and up	398- 5454A 7	N/A
V-225 Carbed (3.0L)		USA 0D280813 - 0G129221	N/A	N/A
V-225 Carbed (3.0L)		USA 0G129222 - 0T408999	398- 821935A 5	N/A
V-225 EFI		USA 0G129222 - 0T408999	398- 821935A 5	N/A
V-250 EFI		USA 0G129222 - 0T408999	398- 821935A 5	N/A
V-250 Carbed (3.4L)	Mounted with 4 standard screws and used with water cooled voltage regulator	USA 0C101891 and up	N.L.A.	N/A
V-250 Carbed (3.4L)	Mounted with 5 metric screws and used with water cooled voltage regulator	USA 0C101891 and up	N.L.A.	N/A
V-250 Carbed (3.4L)	Mounted with 5 metric screws and used with 815279T voltage regulator	USA 0C101891 and up	N.L.A.	N/A
V-300 Carbed (3.4L)		USA 5611648 and up	N.L.A.	N/A

(1) Outboards using 16 amp kit will require the installation of a new style attenuator plate part no. 42970A 2, to provide a mounting location for the voltage regulator.

STARTER MOTORS & COMPONENT PARTS

STARTER MOTOR KIT



50- 55601A 2

40 Hp 2 Cyl. 2 Cycle

STARTER MOTOR ASSY.



50- 898265010

90 - 140 Hp In-Line 6
V-150, V-175, XR2

STARTER MOTOR ASSY.



50-803835T02

9.9 hp. FourStroke Outboard, beginning with Model Year 2005.

STARTER MOTOR ASSY.

Image not Available.

50-8M0147039

15/20 Carbureted 4 stroke (0R235949 thru 0R833819), 25/30 EFI 4 stroke (0R106999 & up)

STARTER MOTOR ASSY.



50-859168T

9.9 hp. FourStroke, 323cc., 1999-2004.
15 hp. FourStroke, 323cc., 1998 & newer.

STARTER MOTOR ASSY.



50-881368T 2

See application chart

STARTER MOTOR ASSY.



50-888333T 1

See application chart

STARTER MOTOR ASSY.



50-892339T01

Fits numerous FourStroke and 2-cycle outboards, EFI, DFI and Verados. Review the Electronic Parts Catalog for your specific application.

STARTER MOTOR ASSY.



50-893886T

See application chart

STARTER MOTOR ASSY.



50-893887T

See application chart

STARTER MOTOR ASSY.



50-893888T

Fits 40/50/60 Hp. FourStroke outboards. Replaces 884044T and 888161T. Review the Electronic Parts Catalog for your specific application.

ELECTRICAL SYSTEM

STARTER MOTOR ASSY.



50-893890T
30 - 60 Hp 2 & 3 Cyl.

STARTER MOTOR ASSY.



50-893891T
65 - 90 Hp 3 Cyl.

STARTER MOTOR ASSY.



50-893892T
100, 115, 125 Hp 4 Cyl.

STARTER MOTOR KIT



50-879150A85
See application chart

STARTER MOTOR ASSY.

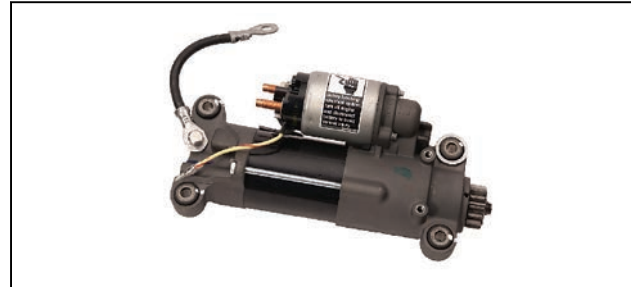

50-879345T77
See application chart

STARTER MOTOR ASSY.



50-898265003
See application chart

STARTER MOTOR ASSY.



50-898265010
90 - 140 Hp In-Line 6
V-150, V-175, XR2

STARTER MOTOR ASSY.



50-8M0033984
9.9 - 25 Hp

STARTER MOTOR

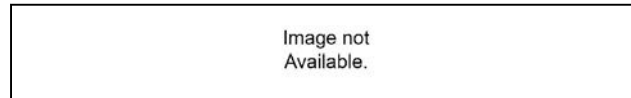

50-8M0137769
75-115 Hp FourStroke

STARTER MOTOR



50-8M0096343

See application chart

STARTER MOTOR ASSY.

Image not Available.

50-8M0134475

15/20 EFI FourStroke outboard, 0R833820 and above.
Quicksilver Branded

INTERNAL SOLENOID



881371T 1

An integral part of the starter assembly.

INTERNAL SOLENOID



888339A 1

An integral part of the starter assembly.

STARTER DRIVE



68575 3

See application chart

STARTER DRIVE



57380

See application chart

STARTER DRIVE



13310T 1

See application chart

STARTER DRIVE



96562

See application chart

STARTER DRIVE



803836

9.9 hp. FourStroke Outboard, beginning with Model Year 2005.

STARTER DRIVE KIT

Image not Available.

8M0135711

15/20 EFI FourStroke outboard, 0R833820 and above.
Quicksilver Branded

STARTER DRIVE



804319

See application chart

STARTER DRIVE



853806 1

See application chart

STARTER DRIVE



43-880805A 1

See application chart

DRIVE RETAINER KIT



90643

See application chart

DRIVE RETAINER KIT



90643 1

See application chart

DRIVE RETAINER KIT



90643 2

See application chart

DRIVE RETAINER KIT



90645

See application chart

DRIVE RETAINER KIT



804320

See application chart

DRIVE RETAINER KIT



820620

See application chart

DRIVE RETAINER KIT



823640 1

See application chart

DRIVE KIT



823640T

See application chart

STARTER MOTORS AND COMPONENTS CHARTS

Mercury/Mariner Starter Motors

Original Starter Motor	Pinion Teeth	New Replacement Starter Motor	Original Brush Set	Original Drive Assy	Original Drive Retainer Kit	Drive Cap	Commutator Cap	Internal Solenoid
38890A 1	9	50-55601A 2	N.L.A.	N.L.A.	N.L.A.	N.L.A.	N.L.A.	N/A
41583T	10	50-898265007(3)	N.L.A.	N.L.A.	N.L.A.	N.L.A.	N.L.A.	N/A
44369A 1	10	N.L.A.	N.L.A.	68575 3	90643	75660	N.L.A.	N/A
45822A 1	10	N.L.A.	N.L.A.	N.L.A.	N.L.A.	N.L.A.	N.L.A.	N/A
47216	10	N.L.A.	N.L.A.	N.L.A.	N.L.A.	N.L.A.	N.L.A.	N/A
55601	9	50-55601A 2	N.L.A.	57380	N.L.A.	N.L.A.	N.L.A.	N/A
55601A 2	9	50-55601A 2	N.L.A.	N.L.A.	N.L.A.	N.L.A.	N.L.A.	N/A
57465A 1	10	50-898265010	N.L.A.	N.L.A.	N.L.A.	N.L.A.	N.L.A.	N/A
57867A 1	10	N.L.A.	N.L.A.	N.L.A.	N.L.A.	N.L.A.	N.L.A.	N/A
58788	10	N.L.A.	N.L.A.	N.L.A.	N.L.A.	N.L.A.	N.L.A.	N/A
58788A 3	10	N.L.A.	N.L.A.	N/A	N.L.A.	N.L.A.	N.L.A.	N/A
60315	10	N.L.A.	N.L.A.	N/A	N.L.A.	N.L.A.	N.L.A.	N/A
64975	10	50-898265010	N.L.A.	N/A	N.L.A.	N.L.A.	N.L.A.	N/A
65436	10	N.L.A.	N.L.A.	68575 3	90643	NSS	15386001	N/A
66015 2	10	50-893891T	N.L.A.	68575 3	90643	75660	15386001	N/A
66015 3	8	50-893892T	N.L.A.	13310T 1	N.L.A.	75660	15386001	N/A
67341	10	N.L.A.	N.L.A.	68575 3	90643	N.L.A.	N.L.A.	N/A
72467	10	50-898265010	N.L.A.	68575 3	90643	75660	15386001	N/A
73521T	10	N.L.A.	N.L.A.	68575 3	90643	75660	N.L.A.	N/A
73531	10	N.L.A.	N/A(1)	96562	N.L.A.	N.L.A.	N.L.A.	N/A
76275	10	N.L.A.	N/A(1)	96562	N.L.A.	N.L.A.	N.L.A.	N/A
77141	8	N.L.A.	N.L.A.	13310T 1	90645	75660	15386001	N/A
78011	10	N.L.A.	N/A(1)	96562	N.L.A.	N.L.A.	N.L.A.	N/A

Not all parts listed are available for the European, C.I.S., Africa and Middle East Markets.
 For more information, please contact your local Mercury, Mariner, MerCruiser or Quicksilver Office.

ELECTRICAL SYSTEM

MERCURY® OUTBOARDS

Original Starter Motor	Pinion Teeth	New Replacement Starter Motor	Original Brush Set	Original Drive Assy	Original Drive Retainer Kit	Drive Cap	Commutator Cap	Internal Solenoid
79472 1	8	NLA	NLA	13310T 1	90645	75660	15386001	N/A
79472T 2	8	NLA	NLA	NLA	90645	75660	15386001	N/A
86976	9	N.L.A.	NLA	NLA	N.L.A.	75660	15386001	N/A
88656	10	N.L.A.	N.L.A.	N.L.A.	N.L.A.	N.L.A.	N.L.A.	N/A
90983A 1	10	50-8M0033984	N/A(1)	96562	N.L.A.	96563T	N.L.A.	N/A
90983T 1	10	50-8M0033984	N/A(1)	96562	N.L.A.	96563T	N.L.A.	N/A
97949A 1	10	N.L.A.	N.L.A.	N.L.A.	N.L.A.	N.L.A.	N.L.A.	N/A
803835T02		50-803835T02	803837A02	803836	N/A	N/A	N/A	N/A
818445 5	8	NLA	NLA	13310T 1	823640T	N.L.A.	N.L.A.	N/A
819968 4		50-898265003	F15190	N.L.A.	820620	N.L.A.	852082	N/A
822462T 1	10	50-893890T	NLA	68575 3	90643	N.L.A.	N.L.A.	N/A
830308	9	50-893886T	NLA	N.L.A.	90643 2	N.L.A.	N.L.A.	N/A
832997 2	8		NLA	13310T 1	90645	851990	N.L.A.	N/A
833153 5	9	NLA	NLA	NLA	823640 1	N.L.A.	N.L.A.	N/A
834749	9	NLA	NLA	N.L.A.	90643 1	N.L.A.	N.L.A.	N/A
852570	9	50-859168T	NLA	N.L.A.	90643 2	N.L.A.	N.L.A.	N/A
853329T	14	50-892339T01	NSS	43-880805A 1	NSS(2)	NSS	NSS	N/A
853805T03		50-8M0147039	8M0135544	853806 1	NSS(2)	NSS	NSS	N/A
854636T	9	50-893887T	NLA	N/A	90643 2	N.L.A.	N.L.A.	N/A
859169T	9	50-893886T	NLA	N.L.A.	N.L.A.	N.L.A.	N.L.A.	N/A
859170T	9	50-893887T	NLA	N.L.A.	N.L.A.	N.L.A.	N.L.A.	N/A
859170T 1	9	50-893887T	NLA	N.L.A.	N.L.A.	N.L.A.	N.L.A.	N/A
859171T	9	NLA	NLA	N.L.A.	N.L.A.	N.L.A.	N.L.A.	N/A
879150A85	14	50-879150A85	NSS	NSS	NSS	NSS	NSS	NSS
884044T	9	50-893888T	NLA	N.L.A.	N.L.A.	N.L.A.	N.L.A.	N/A
884045T	9	50-893887T	NLA	N.L.A.	N.L.A.	N.L.A.	N.L.A.	N/A
881368T 1	13	50-881368T 2	804316	804319	804320	N/A	N.L.A.	881371T 1
881368T 2	13	50-881368T 2	804316	804319	804320	N/A	N.L.A.	881371T 1
888151T	9	50-893886T	NLA	N.L.A.	N.L.A.	N.L.A.	N.L.A.	N/A
888160T	9	50-893887T	NLA	N.L.A.	N.L.A.	N.L.A.	N.L.A.	N/A
888161T	9	50-893888T	NLA	N.L.A.	N.L.A.	N.L.A.	N.L.A.	N/A
888333T 1	13	50-888333T 1	888335	804319	804320	N/A	N.L.A.	888339A 1
892339T	14	50-892339T01	NSS	43-880805A 1	NSS(2)	NSS	NSS	809463A 1
892339T01	14	50-892339T01	8M0065258	43-880805A 1	NSS(2)	NSS	NSS	809463A 1
893886T	9	50-893886T	NSS	NSS	NSS	NSS	NSS	N/A
893887T	9	50-893887T	NSS	NSS	NSS	NSS	NSS	N/A
893888T	9	50-893888T	NSS	NSS	NSS	NSS	NSS	N/A
893890T	10	50-893890T	NLA	68575 3	90643	N.L.A.	N.L.A.	N/A
893891T	10	50-893891T	NLA	68575 3	90643	75660	15386001	N/A
893892T	8	50-893892T	NSS	NSS	NSS	NSS	NSS	N/A
879345T77	14	50-879345T77	NSS	NSS	NSS	NSS	NSS	NSS
897525T03	14	50-879150A85	NSS	NSS	NSS	NSS	NSS	NSS
897525T05	14	50-879150A85	NSS	NSS	NSS	NSS	NSS	NSS
898265003		50-898265003	NSS	NSS	NSS	NSS	NSS	NSS
8M0074530		50-8M0096343	NSS	NSS	NSS	NSS	NSS	NSS
8M0079328		50-8M0096343	NSS	NSS	NSS	NSS	NSS	NSS
8M0088064		50-8M0137769	NSS	NSS	NSS	NSS	NSS	NSS
8M0096343		50-8M0096343	NSS	NSS	NSS	NSS	NSS	NSS

(1) Brushes and springs are part of the End Cap Assembly.

(2) Retaining ring included with pinion gear.

(3) Order from Land N Sea

SOLENOIDS - STARTER & POWER TRIM

STARTER RELAY



8M0098898

See application chart

SOLENOID



25661T 1

Used for power trim and starting systems
Fits various O/B & MCM applications

SOLENOID



89- 96054T

Flat mounting plate
Fits In-Line 6 Outboards & MerCruiser engines

SOLENOID



89- 96158T

Stepped mounting plate
Fits Outboard Starters & MerCruiser Starters and Pwr Trim.

STARTER SOLENOID



809463A 1

For MCM Delco Remy PG 260 series starter and found in numerous outboard applications from the 75/90 (1.5L) through the 225 hp. DFI engines, 3.0L EFI product and also the 200-300 hp. Verado.

SOLENOID



89-817109A 2

Fits Outboard 3 Cyl. - V-6

SOLENOID



89-818999A 2

Used for starting systems
Fits various O/B and MCM applications

SOLENOID



89-850187T 1

Contains rubber insulating mounts.
Review the Electronic Parts Catalog for your specific application.

ELECTRICAL SYSTEM

SOLENOID



89-850188T 1

Fits Outboard 6 - 25 Hp and 50 - 60 Hp 3 Cyl. & MCM applications

SOLENOID



89-850189T

See application chart

SOLENOID



89-853654A 1

Fits Outboard 2 Cyl. & In-Line 6 & MCM applications

SOLENOID



89-853809001

Used on the 9.9 hp. FourStroke (electric model) outboard, beginning with Model Year 2005 and the 25/30 hp. EFI FourStroke outboards beginning with serial number 0R106999.

POWER TRIM SOLENOID



89-818997T 1

See application chart

POWER TRIM SOLENOID



89-818864T

See application chart

RELAYS - POWER TRIM

RELAY



882751

Fits various O/B and MCM applications

RELAY ASSEMBLY



882751A 1

Includes rubber insulating mount.
Review the Electronic Parts Catalog for your specific application.

POWER TRIM RELAY

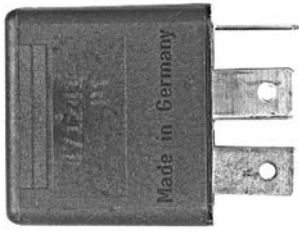

87- 18211

See application chart

POWER TRIM RELAY

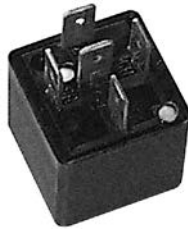

87- 19761

40 Horsepower 2 stroke w/relays (0C159200 & up, Bel 9570790 & up)

RELAY



821509T01

45 Horsepower 4 stroke, Bodensee 0G231123-0G472132. 50 Horsepower 4 stroke, 0G231123-0T178499.

RELAY



87- 851839T02

Used on the 9.9 hp. FourStroke (electric model) outboard, beginning with Model Year 2005.

RELAY



881352T

75-115 EFI Horsepower 4 stroke, 0T801000 thru 1B366822. 225 EFI Horsepower 4 stroke, 0T653945 & up.

RELAY



881356001

See application chart

RELAY



888320T

See application chart

POWER TRIM RELAY KIT



882751A 3

See application chart

ELECTRICAL SYSTEM

RELAY



882751A04

Used on 200/225/250/275 Verado outboards beginning with Model Year 2005. Also used on MCM 496 & MIE 8.1L.

SOLENOID AND RELAY CHART - MERCURY/MARINER

FourStroke Solenoid and Relay Chart

Model	Model Notes	Serial # Range	Starter Solenoid/Relay	Power Trim Relay
4 FourStroke		JPN 0R000001 and up	N/A	N/A
		BEL 0P073456 and up		
5 FourStroke		JPN 0R000001 and up	N/A	N/A
		BEL 0P073456 and up		
6 FourStroke		JPN 0R000001 and up	N/A	N/A
		BEL 0P073456 and up		
8 FourStroke	232cc	USA 0G760300 - 0T178499	N.L.A.	N/A
		USA 0H017100 - 0H017349		
8 FourStroke	323cc	BEL 0P075166 - 0P325499	8M0098898	N/A
9.9 FourStroke	232cc	USA 0H000058 - 0H016909	N.L.A.	N/A
9.9 FourStroke	323cc	USA 0G760300 - 0T979999	8M0098898	N/A
		BEL 0P075166 - 0P325499		
9.9 FourStroke	209cc	JPN 0R042475 and up	89-853809001	87-851839T02
		BEL 0P325500 and up		
15 FourStroke	323cc	USA 0G760300 - 1B727495	8M0098898	N/A
		BEL 0P075166 and up		
15 FourStroke	351cc	JPN 0R235949 and up	89-853809002	87-851839T02
20 FourStroke	351cc	JPN 0R235168 and up	89-853809002	87-851839T02
25 FourStroke	Carb	USA 0G590000 - 1B344298	89-850187T 1	N/A
		BEL 9973100 - 0P388282		
25 FourStroke	EFI	JPN 0R106999 and up	89-853809001	(3)
30 FourStroke	Carb	USA 0G760300 and up	89-850187T 1	882751A 1
		BEL 0P153500 and up		
30 FourStroke	EFI	USA 0T409000 - 1B226999	8M0098898	882751A 1
30 FourStroke	EFI	JPN 0R106999 and up	89-853809001	(3)
40 FourStroke	Carb, 3 cylinder	USA 0G760300 and up	89-850187T 1	882751A 1
		BEL 0P153500 and up		
40 FourStroke	EFI, 3 cylinder	USA 0T409000 and up	8M0098898	882751A 1
		BEL 0P153500 and up		
		CHN 1C000001 and up		
40 FourStroke	Carb, 4 cylinder	USA 0T228405 - 0T598999	8M0098898	882751A 1
		BEL 0P094500 - 0P206999		
40 FourStroke	EFI, 4 cylinder	USA 0T409000 and up	8M0098898	882751A 1
		BEL 0P153500 and up		
		CHN 1C000001 and up		
45 FourStroke	Bodensee	USA 0G231123 - 0G472132	8M0098898	821509T01

ELECTRICAL SYSTEM

Model	Model Notes	Serial # Range	Starter Solenoid/Relay	Power Trim Relay
45 FourStroke	Bodensee	USA 0G472133 - 0T178499	8M0098898	882751A 1
50 FourStroke		USA 0G231123 - 0T178499	8M0098898	821509T01
50 FourStroke	Carb, 4 cylinder, 996cc	USA 0T178500 - 0T598999	8M0098898	882751A 1
		BEL 0P094500 - 0P206999		
50 FourStroke	EFI, 4 cylinder, 996cc	USA 0T409000 and up	8M0098898	882751A 1
		BEL 0P153500 and up		
		CHN 1C000001 and up		
60 FourStroke	Carb, 4 cylinder, 996cc	USA 0T178500 - 0T598999	8M0098898	882751A 1
		BEL 0P094500 - 0P206999		
60 FourStroke	EFI, 4 cylinder, 996cc	USA 0T409000 and up	8M0098898	882751A 1
		BEL 0P153500 and up		
		CHN 1C000001 and up		
75 FourStroke	Carb, 1596cc	USA 0G960500 - 1B226999	8M0098898	(2)
		BEL 0P094500 - 0P400999		
75 FourStroke	EFI, 1596cc	USA 1B172291 - 1B366822	881352T	881356001
75 FourStroke	EFI, 1731cc	USA 1B366823 - 2B094995	89-817109A 2	882751
		BEL 0P459572 and up		
75 FourStroke	2.1L	USA 2B094996 and up	882751	882751
90 FourStroke	Carb, 1596cc	USA 0G960500 - 1B226999	8M0098898	(2)
		BEL 0P094500 - 0P400999		
90 FourStroke	EFI, 1596cc	USA 1B172291 - 1B366822	881352T	881356001
90 FourStroke	EFI, 1731cc	USA 1B366823 - 2B094995	89-817109A 2	882751
		BEL 0P459572 and up		
90 FourStroke	2.1L	USA 2B094996 and up	882751	882751
115 FourStroke	EFI, w/single relay trim	USA 0T178500 - 0T800999	881352T	882751A 3
115 FourStroke	EFI, w/two relay trim	USA 0T178500 - 0T800999	881352T	882751A 1
115 FourStroke	EFI, 1741cc	USA 0T809000 - 1B366822	881352T	882751A 1
115 FourStroke	EFI, 1731cc	USA 1B366823 - 2B094995	89-817109A 2	882751
		BEL 0P459572 and up		
115 FourStroke	2.1L	USA 2B094996 and up	882751	882751
135 FourStroke	Verado	USA 1B227000 and up	882751A04	882751A04
		BEL 0P419487 and up		
150 FourStroke	EFI	USA 1B905505 and up	8M0057697	8M0057697
150 FourStroke	Verado	USA 1B227000 and up	882751A04	882751A04
		BEL 0P419487 and up		
175 FourStroke	Verado	USA 1B227000 and up	882751A04	882751A04
		BEL 0P419487 and up		
200 FourStroke	4 cyl., Verado	USA 1B517159 and up	882751A04	882751A04
		BEL 0P514869 and up		
200 FourStroke	6 cyl., Verado	USA 0T980000 and up	882751A04	882751A04
		BEL 0P409357 and up		
225 FourStroke	EFI	USA 0T653945 and up	881352T	888320T
225 FourStroke	6 cyl., Verado	USA 0T980000 and up	882751A04	882751A04
		BEL 0P409357 and up		
250 FourStroke	6 cyl., Verado	USA 0T980000 and up	882751A04	882751A04
		BEL 0P409357 and up		
275 FourStroke	6 cyl., Verado	USA 0T980000 and up	882751A04	882751A04
		BEL 0P409357 and up		
300 FourStroke	6 cyl., Verado	USA 1B517434 and up	882751A04	882751A04
		BEL 0P520553 and up		
350Sci FourStroke	6 cyl., Verado (Race)	USA 1B716557 - 2B143542	882751A04	882751A04

(2) For an UP relay order 804281T. For a DOWN relay order 804282T.

(3) For an UP relay order 898103T09. For a DOWN relay order 898103T10.

ELECTRICAL SYSTEM

MERCURY® OUTBOARDS

2-Cycle Solenoid and Relay Chart

Model	Model Notes	Serial # Range	Starter Solenoid	Power Trim Solenoid	Power Trim Relay
6		USA 0A197112 - 0D280999	89- 96054T	N/A	N/A
		BEL 9461526 - 9792199			
6		USA 0D281000 - 0T800749	89- 850189T	N/A	N/A
		BEL 9792200 and up			
8		USA 0A197112 - 0D280999	89- 96054T	N/A	N/A
		BEL 9461526 - 9792199			
8		USA 0D281000 and up	89- 850189T	N/A	N/A
		BEL 9792200 and up			
9.9		USA 0A197112 - 0D280999	89- 96054T	N/A	N/A
		BEL 9461526 - 9792199			
9.9		USA 0D281000 and up	89- 850189T	N/A	N/A
		BEL 9792200 and up			
18 (18, 18XD)		USA 5837437 and up	89- 96054T	N/A	N/A
		AUS 8071973 and up			
		BEL 9308306 and up			
		CAN 7173723 and up			
20 (200, 20)		USA 4709593 - 6443972	89- 853654A 1	N/A	N/A
		AUS 8045199 and up			
		BEL 9157230 - 9415100			
		CAN 7098523 - 7209532			
20 (20, 20XD)		USA 6443973 - 0G044026	89- 96054T	N/A	N/A
		BEL 9415101 - 9807908			
		CAN 7209533 and up			
20		USA 0G044027 - 0T979999	89- 850188T 1	N/A	N/A
		BEL 9807909 and up			
20 JET		USA 0G044027 and up	89- 850188T 1	N/A	N/A
		BEL 9807909 - 0P325499			
25 (25, 25XD)(2 cyl)	2 cylinder	USA 5705532 - 0G044026	89- 96054T	N/A	N/A
		AUS 8073158 and up			
		BEL 9315316 - 9807908			
		CAN 7166928 and up			
25	2 cylinder	USA 0G044027 and up	89- 850188T 1	N/A	N/A
		BEL 9807909 and up			
30	2 cylinder, 644cc	USA 0G053314 and up	89- 850187T 1	N/A	882751A 1
		BEL 0P017000 and up			
30	2 cylinder, 430cc	USA 0G575500 and up	89- 853809T	N/A	N/A
30 JET	Non-handle	USA 0C159200 - 0G589999	89- 96054T	N/A	N/A
30 JET	Non-handle	USA 0G590000 - 0T178499	89- 850187T 1	N/A	N/A
35	2 cylinder w/3 Ram Trim	USA 6445653 - 0C159199	89- 96158T	89- 96158T	N/A
		BEL 9384476 and up			
		CAN 7209608 and up			
35	2 cylinder w/1 Ram Trim	USA 0C159200 and up	89- 96158T	N/A	87- 18211
		BEL			
40 (40, 402, 400)	2 cylinder	USA 2874704 - 5556229	25661T 1	N/A	N/A
		AUS 8002335 - 8064749			
		BEL 3339688 - 9251455			
		CAN 3340783 - 7144762			
40	2 cylinder	USA 5556230 - 5823917	89- 853654A 1	N/A	N/A
		AUS 8064750 - 8070639			
		BEL 9251456 - 9298955			
		CAN 7144763 - 7169337			

ELECTRICAL SYSTEM

MERCURY® OUTBOARDS

Model	Model Notes	Serial # Range	Starter Solenoid	Power Trim Solenoid	Power Trim Relay
40	2 cylinder	USA 5823918 - 0G053313	89- 96158T	N/A	N/A
		AUS 8070640 and up			
		BEL 9298956 and up			
		CAN 7169338 and up			
40	2 cylinder	USA 0G053314 and up	89- 850187T 1	N/A	882751A 1
40	3 cylinder	USA 0G531301 - 0T999999	89- 850187T 1	N/A	882751A 1
		BEL 9973100 and up			
40	4 cylinder w/solenoids	USA 0C159200 and up	89- 96054T	89- 818999A 2	N/A
		BEL 9570790 and up			
40	4 cylinder w/relays	USA 0C159200 and up	89- 96054T	N/A	87- 19761
		BEL 9570790 and up			
40 JET	3 cylinder	USA 0T178500 and up	89- 850187T 1	N/A	882751A 1
45	4 cylinder wo/trim circuit breaker & fuse	USA 5531630 - 6146848	89- 853654A 1	89- 853654A 1	N/A
		AUS 8063985 - 8075602			
		BEL 9248006 - 9362390			
		CAN 7143688 - 7198592			
45	4 cylinder w/trim circuit breaker & fuse	USA 5531630 - 6146848	89- 853654A 1	89- 96158T	N/A
		AUS 8063985 - 8075602			
		BEL 9248006 - 9362390			
		CAN 7143688 - 7198592			
45	4 cylinder wo/trim circuit breaker & fuse	USA 6146849 - 0B110788	89- 96158T	89- 853654A 1	N/A
		BEL 9362391 - 9466691			
		CAN 7198593 - 0A719280			
45	4 cylinder w/trim circuit breaker & fuse	USA 6146849 - 0B110788	89- 96158T	89- 96158T	N/A
		BEL 9362391 - 9466691			
		CAN 7198593 - 0A719280			
45 (4 cyl)	4 cylinder	USA 0B110789 and up	89- 96158T	89- 96158T	N/A
		BEL 9466692 and up			
		CAN 0A719281 and up			
45 JET	w/flush mount starter solenoid	USA 0D000750 - 0G290584	89- 96054T	N/A	N/A
45 JET	w/rubber bushing mount starter solenoid	USA 0D000750 - 0G290584	89- 850188T 1	N/A	N/A
45 JET		USA 0G290585 - 0G589999	89- 818999A 2	N/A	N/A
45 JET		USA 0G590000 - 0T178499	89- 850187T 1	N/A	N/A
50 (500)		USA 2858814 - 3008818	N.L.A.	N/A	N/A
		AUS 2863739 - 3015353			
		CAN 2742142 - 3015453			
50 (500)		USA 3008819 - 4140999	25661T 1	N/A	N/A
		AUS 3015354 - 8029514			
		BEL 9001581 - 9082513			
		CAN 3015454 - 7051982			
50 (50, 500)		USA 4141000 - 5531629	89- 853654A 1	N/A	N/A
		AUS 8029515 - 8063984			
		BEL 9082514 - 9248005			
		CAN 7051983 - 7143687			
50	4 cylinder wo/trim circuit breaker & fuse	USA 5531630 - 6146848	89- 853654A 1	89- 853654A 1	N/A
		AUS 8063985 - 8075602			
		BEL 9248006 - 9362390			
		CAN 7143688 - 7198592			
50	4 cylinder w/trim circuit breaker & fuse	USA 5531630 - 6146848	89- 853654A 1	89- 96158T	N/A
		AUS 8063985 - 8075602			
		BEL 9248006 - 9362390			
		CAN 7143688 - 7198592			

Not all parts listed are available for the European, C.I.S., Africa and Middle East Markets.
 For more information, please contact your local Mercury, Mariner, MerCruiser or Quicksilver Office.

ELECTRICAL SYSTEM

MERCURY® OUTBOARDS

Model	Model Notes	Serial # Range	Starter Solenoid	Power Trim Solenoid	Power Trim Relay
50	4 cylinder w/trim circuit breaker & fuse	USA 6146849 and up	89- 96158T	89- 853654A 1	N/A
		BEL 9362391 and up			
		CAN 7198593 and up			
50	4 cylinder w/trim circuit breaker & fuse	USA 6146849 and up	89- 96158T	89- 96158T	N/A
		BEL 9362391 and up			
		CAN 7198593 and up			
50	3 cylinder	USA 6428681 - 0B122929	89- 96054T	89- 96158T	N/A
		BEL 9385911 - 9469199			
		CAN 7208333 - 0A721308			
50	3 cylinder w/3 Ram Trim	USA 0B122930 - 0D000749	89- 96158T	89- 96158T	N/A
		BEL 9469200 - 9683054			
		CAN 0A721309 and up			
50	3 cylinder w/1 Ram Trim	USA 0B122930 - 0D000749	89- 96158T	N/A	87- 18211
		BEL 9469200 - 9683054			
		CAN 0A721309 and up			
50	3 cylinder w/flush mount starter solenoid	USA 0D000750 - 0G290584	89- 96054T	N/A	882751A 1
		BEL 9683055 - 9885344			
50	3 cylinder w/rubber mount starter solenoid	USA 0D000750 - 0G290584	89- 850188T 1	N/A	882751A 1
		BEL 9683055 - 9885344			
50	3 cylinder	USA 0G290585 - 0G589999	89- 818999A 2	N/A	882751A 1
		BEL 9885345 - 9973099			
50	3 cylinder	USA 0G590000 and up	89- 850187T 1	N/A	882751A 1
		BEL 9973100 and up			
55	3 cylinder w/flush mount starter solenoid	USA 0D000750 - 0G290584	89- 96054T	N/A	882751A 1
		BEL 9683055 - 9885344			
55	3 cylinder w/rubber mount starter solenoid	USA 0D000750 - 0G290584	89- 850188T 1	N/A	882751A 1
		BEL 9683055 - 9885344			
55	3 cylinder	USA 0G290585 - 0G589999	89- 818999A 2	N/A	882751A 1
		BEL 9885345 - 9973099			
55	3 cylinder	USA 0G590000 and up	89- 850187T 1	N/A	882751A 1
		BEL 9973100 and up			
60	3 cylinder	USA 6428681 - 0B122929	89- 96054T	89- 96158T	N/A
		BEL 9385911 - 9469199			
		CAN 7208333 - 0A721308			
60	3 cylinder w/3 Ram Trim	USA 0B122930 - 0D000749	89- 96158T	89- 96158T	N/A
		BEL 9469200 - 9683054			
		CAN 0A721309 and up			
60	3 cylinder w/1 Ram Trim	USA 0B122930 - 0D000749	89- 96158T	N/A	87- 18211
		BEL 9469200 - 9683054			
		CAN 0A721309 and up			
60	3 cylinder w/flush mount starter solenoid	USA 0D000750 - 0G290584	89- 96054T	N/A	882751A 1
		BEL 9683055 - 9885344			
60	3 cylinder w/rubber mount starter solenoid	USA 0D000750 - 0G290584	89- 850188T 1	N/A	882751A 1
		BEL 9683055 - 9885344			
60	3 cylinder	USA 0G290585 - 0G589999	89- 818999A 2	N/A	882751A 1
		BEL 9885345 - 9973099			
60	3 cylinder	USA 0G590000 and up	89- 850187T 1	N/A	882751A 1
		BEL 9973100 and up			
65 (650)	4 cylinder	1542745 - 2446774	N.L.A.	N/A	N/A
65 (650)	4 cylinder	2446775 - 3293183	25661T 1	N/A	N/A

Model	Model Notes	Serial # Range	Starter Solenoid	Power Trim Solenoid	Power Trim Relay	
65 (650)	3 cylinder	USA 3547987 - 4571651	89-853654A 1	N/A	N/A	
		AUS 8006640 - 8042349				
		BEL 9020074 - 9135824				
		CAN 7013633 - 7087822				
65 JET		USA	89-850187T 1	N/A	N/A	
65 JET		USA	0G127500 and up	89-817109A 2	N/A	N/A
70	3 cylinder	USA 4571652 - 5579016	89-853654A 1	N/A	N/A	
		AUS 8042350 - 8065064				
		BEL 9135825 - 9255130				
		CAN 7087823 - 7145937				
70	3 cylinder	USA 5579017 - 6104369	89-853654A 1	89-853654A 1	N/A	
		AUS 8065065 - 8068964				
		BEL 9255131 - 9352915				
		CAN 7145938 - 7192547				
70	3 cylinder	USA 6104370 - 6428680	89-96054T	89-853654A 1	N/A	
		BEL 9352916 - 9385910				
		CAN 7192548 - 7208332				
70	3 cylinder	USA 0A996142 - 0C221999	89-96158T	89-96158T	N/A	
		BEL 9483121 - 9589038				
75	4 cylinder	USA 6432901 and up	89-96054T	89-96158T	N/A	
		BEL 9393856 and up				
		CAN 7208573 and up				
75	3 cylinder w/3 Ram Trim	USA 0C222000 - 0D252460	89-850187T 1	89-850187T 1	N/A	
		BEL 9589039 and up				
75	3 cylinder w/1 Ram Trim	USA 0C222000 - 0D252460	89-850187T 1	N/A	882751A 1	
		BEL 9589039 and up				
75	3 cylinder w/1 Ram Trim	USA 0D252461 - 0D283221	89-850187T 1	89-818997T 1	N/A	
		BEL				
75	3 cylinder	USA 0D283222 - 0G127499	89-850187T 1	89-818997T 1	N/A	
		BEL 9793577 - 9836632				
75	3 cylinder	USA 0G127500 - 0G360002	89-817109A 2	89-818997T 1	N/A	
		BEL 9836633 - 9934136				
75	3 cylinder	USA 0G360003 and up	89-817109A 2	N/A	882751A 1	
		BEL 9934137 and up				
75 Optimax	3 cylinder, 1.5L	USA 0T801000 and up	89-817109A 2	N/A	882751A 1	
80 (800)	4 cylinder	2559001 - 3493912	25661T 1	N/A	N/A	
80 (800)	4 cylinder	USA 4831999 - 5582561	89-853654A 1	N/A	N/A	
		AUS 8050200 - 8067014				
		BEL 9177626 - 9256130				
		CAN 7110998 - 7146212				
80	4 cylinder wo/trim circuit breaker & fuse	USA 5582562 - 6030903	89-853654A 1	89-853654A 1	N/A	
		AUS 8067015 - 8074612				
		BEL 9256131 - 9345615				
		CAN 7146213 - 7189007				
80	4 cylinder w/trim circuit breaker & fuse	USA 5582562 - 6030903	89-853654A 1	89-96158T	N/A	
		AUS 8067015 - 8074612				
		BEL 9256131 - 9345615				
		CAN 7146213 - 7189007				
80	4 cylinder wo/trim circuit breaker & fuse	USA 6030903 - 6432900	89-96054T	89-853654A 1	N/A	
		AUS 8074612 and up				
		BEL 9345615 - 9393855				
		CAN 7189007 - 7208572				

ELECTRICAL SYSTEM

MERCURY® OUTBOARDS

Model	Model Notes	Serial # Range	Starter Solenoid	Power Trim Solenoid	Power Trim Relay
80	4 cylinder w/trim circuit breaker & fuse	USA 6030903 - 6432900	89- 96054T	89- 96158T	N/A
		AUS 8074612 and up			
		BEL 9345615 - 9393855			
		CAN 7189007 - 7208572			
80	3 cylinder	USA 0A996142 and up	89- 96158T	89- 96158T	N/A
		BEL 9483121 and up			
80 JET	4 cylinder	USA 0D283222 and up	89-817109A 2	N/A	N/A
80 JET	3 cylinder	USA 1B586067 and up	89-817109A 2	N/A	882751A 1
85 (850)	4 cylinder	USA 3493913 - 3865694	25661T 1	N/A	N/A
		AUS 8005440 - 8017139			
		BEL 9011604 - 9053363			
		CAN 7010108 - 7033027			
85 (850)	4 cylinder	USA 3865695 - 4831998	89-853654A 1	N/A	N/A
		AUS 8017140 - 8050199			
		BEL 9053364 - 9177625			
		CAN 7033028 - 7110997			
90 (90, 900)	6 cylinder	USA 4845301 - 5299505	89-853654A 1	89-853654A 1	N/A
		CAN 7111698 - 7123762			
90	6 cylinder	USA 5299506 - 5594656	89-853654A 1	89-853654A 1	N/A
		AUS 8060545 - 8060694			
90	6 cylinder wo/trim circuit breaker & fuse	USA 5594657 - 6026608	89-853654A 1	89-853654A 1	N/A
		AUS 8071020 - 8074512			
		CAN 7147088 - 7185072			
90	6 cylinder w/trim circuit breaker & fuse	USA 5594657 - 6026608	89-853654A 1	89-96158T	N/A
		AUS 8071020 - 8074512			
		CAN 7147088 - 7185072			
90	6 cylinder wo/trim circuit breaker & fuse	USA 6026609 - 6436122	89-96054T	89-853654A 1	N/A
		AUS 8074513 and up			
		CAN 7185073 - 7208847			
90	6 cylinder w/trim circuit breaker & fuse	USA 6026609 - 6436122	89-96054T	89-96158T	N/A
		AUS 8074513 and up			
		CAN 7185073 - 7208847			
90	6 cylinder	USA 6436123 and up	89-96054T	89-96158T	N/A
		CAN 7208848 and up			
90	3 cylinder	USA 0A996142 - 0C221999	89-96158T	89-96158T	N/A
		BEL 9483121 - 9589038			
90	3 cylinder w/3 Ram Trim	USA 0C222000 - 0D252460	89-850187T 1	89-850187T 1	N/A
		BEL 9589039 and up			
90	3 cylinder w/1 Ram Trim	USA 0C222000 - 0D252460	89-850187T 1	N/A	882751A 1
		BEL 9589039 and up			
90	3 cylinder w/1 Ram Trim	USA 0D252461 - 0D283221	89-850187T 1	89-818997T 1	N/A
		BEL			
90	3 cylinder	USA 0D283222 - 0G127499	89-850187T 1	89-818997T 1	N/A
		BEL 9793577 - 9836632			
90	3 cylinder	USA 0G127500 - 0G360002	89-817109A 2	89-818997T 1	N/A
		BEL 9836633 - 9934136			
90	3 cylinder	USA 0G360003 and up	89-817109A 2	N/A	882751A 1
		BEL 9934137 and up			
90 Optimax	3 cylinder, 1.5L	USA 0T801000 and up	89-817109A 2	N/A	882751A 1
100 (1000 SS)		2318586 - 2836018	25661T 1	N/A	N/A
100 (1000 BP)		2399698 - 3253111	25661T 1	N/A	N/A
100	4 cyl. w/ 3 Ram Trim & 5/16-18 starter terminal	USA 0B209468 - 0D252460	89-817109A 2	89-850187T 1	N/A(1)
		BEL 9523034 and up			

ELECTRICAL SYSTEM

MERCURY® OUTBOARDS

Model	Model Notes	Serial # Range	Starter Solenoid	Power Trim Solenoid	Power Trim Relay
100	4 cyl. w/ 1 Ram Trim & 5/16-18 starter terminal	USA 0B209468 - 0D252460 BEL 9523034 and up	89-817109A 2	N/A	882751A 1(1)
100	4 cylinder w/ 5/16-18 starter terminal	USA 0D252461 - 0D283221 BEL	89-817109A 2 89-817109A 2	89-818997T 1	N/A(1)
100	4 cylinder	USA 0D283222 - 0G359967 BEL 9793577 - 9934136	89-817109A 2	89-818997T 1	N/A
100	4 cylinder	USA 0G359968 and up BEL 9934137 and up	89-817109A 2	N/A	882751A 1
110 (1100)	6 cylinder	1870204 - 2314955	25661T 1	N/A	N/A
115 (1150)	6 cylinder	USA 2836019 - 4112634 AUS 8008665 - 8027114 CAN 7010763 - 7047257	25661T 1	25661T 1	N/A
115 (115, 1150)	6 cylinder	USA 4112635 - 5600966 AUS 8027115 - 8061269 CAN 7047258 - 7147987	89-853654A 1	89-853654A 1	N/A
115	6 cylinder wo/trim circuit breaker & fuse	USA 5600967 - 6051525 AUS 8061270 - 8071274 CAN 7147988 - 7186572	89-853654A 1	89-853654A 1	N/A
115	6 cylinder w/trim circuit breaker & fuse	USA 5600967 - 6051525 AUS 8061270 - 8071274 CAN 7147988 - 7186572	89-853654A 1	89-96158T	N/A
115	6 cylinder wo/trim circuit breaker & fuse	USA 6051526 - 6436122 CAN 7186573 - 7208847	89-96054T	89-96158T	N/A
115	6 cylinder w/trim circuit breaker & fuse	USA 6051526 - 6436122 CAN 7186573 - 7208847	89-96054T	89-96158T	N/A
115	6 cylinder	USA 6436123 and up CAN 7208848 and up	89-96054T	89-96158T	N/A
115	4 cyl. w/ 3 Ram Trim & 5/16-18 starter terminal	USA 0C100000 - 0D252460 BEL 9559771 and up	89-817109A 2	89-850187T 1	N/A(1)
115	4 cyl. w/ 1 Ram Trim & 5/16-18 starter terminal	USA 0C100000 - 0D252460 BEL 9559771 and up	89-817109A 2	N/A	882751A 1(1)
115	4 cylinder w/ 5/16-18 starter terminal	USA 0D252461 - 0D283221 BEL	89-817109A 2	89-818997T 1	N/A(1)
115	4 cylinder	USA 0D283222 - 0G359967 BEL 9793577 - 9934136	89-817109A 2	89-818997T 1	N/A
115	4 cylinder	USA 0G359968 and up	89-817109A 2	N/A	882751A 1
115	4 cylinder	BEL 9934137 and up	89-817109A 2	N/A	882751A 1
115 Optimax	3 cylinder, 1.5L	USA 0T801000 and up	89-817109A 2	N/A	882751A 1
115 Pro XS		USA 1B751825 and up	89-817109A 2	N/A	882751A 1
125 (1250, 1250 BP)	6 cylinder	2314956 - 3253111	25661T 1	N/A	N/A
125	4 cylinder	USA 0D283222 - 0G359967 BEL 9793577 - 9934136	89-817109A 2	89-818997T 1	N/A
125	4 cylinder	USA 0G359968 and up BEL 9934137 and up	89-817109A 2	N/A	882751A 1
125 Optimax	3 cylinder, 1.5L	USA 1B736885 and up	89-817109A 2	N/A	882751A 1
135 (1350)	6 cylinder	2839369 - 3293233	25661T 1	N/A	N/A
140 (1400)	6 cylinder	3293234 - 3502805	25661T 1	25661T 1	N/A
140 (140, 1400)	6 cylinder	USA 4865678 and up AUS 8052650 and up CAN 7112773 and up	89-853654A 1	89-853654A 1	N/A
140 JET		USA 0G303046 - 0T178499	89-817109A 2	N/A	882751A 1
150 (1500)	6 cylinder	USA 3502806 - 4121434 AUS 8005615 - 8028040 CAN 7010533 - 7048782	25661T 1	25661T 1	N/A

Not all parts listed are available for the European, C.I.S., Africa and Middle East Markets.
For more information, please contact your local Mercury, Mariner, MerCruiser or Quicksilver Office.

ELECTRICAL SYSTEM

MERCURY® OUTBOARDS

Model	Model Notes	Serial # Range	Starter Solenoid	Power Trim Solenoid	Power Trim Relay
150 (1500)	6 cylinder	USA 4121435 - 4865677	89-853654A 1	25661T 1	N/A
		AUS 8028041 - 8052649			
		CAN 7048783 - 7112772			
150 (1500XS)		USA 4868648 - 5327662	89-853654A 1	89-853654A 1	N/A
105 JET	V-6 w/flush mounted starter solenoid	USA 0D082000 - 0G303045	89-853654A 1	N/A	N/A
105 JET	V-6 w/rubber mounted starter solenoid	USA 0D082000 - 0G303045	89-817109A 2	N/A	N/A
105 JET	V-6	USA 0G303046 and up	89-817109A 2	N/A	N/A
V-135	w/1/4-20 starter solenoid terminals	USA 0A904646 - 0C100860	89-96054T	89-96158T	N/A
V-135	w/5/16-18 starter solenoid terminals	USA 0A904646 - 0C100860	89-853654A 1	89-96158T	N/A
V-135		USA 0C100861 - 0C239552	89-853654A 1	89-96158T	N/A
V-135	w/standard color trim solenoid	USA 0C239553 - 0D081999	89-853654A 1	89-96158T	N/A
V-135	w/off white color trim solenoid	USA 0C239553 - 0D081999	89-853654A 1	89-818864T	N/A
V-135	w/flush mounted starter solenoid	USA 0D082000 - 0G201874	89-853654A 1	89-818997T 1	N/A
V-135	w/rubber bushing mount starter solenoid	USA 0D082000 - 0G201874	89-817109A 2	89-818997T 1	N/A
V-135	w/flush mounted starter solenoid	USA 0G201875 - 0G303045	89-853654A 1	N/A	882751A 1
V-135	w/rubber bushing mount starter solenoid	USA 0G201875 - 0G303045	89-817109A 2	N/A	882751A 1
V-135		USA 0G303046 and up	89-817109A 2	N/A	882751A 1
V-135 DFI		USA 0G590000 and up	89-817109A 2	N/A	882751A 1
V-150 Mercury		USA 5432022 - 6042945	89-853654A 1	89-96158T	N/A
V-150 Mariner		USA 5432022 - 6038680	89-853654A 1	89-96158T	N/A
V-150 Mercury		USA 6042946 - 0A904645	89-96054T	89-96158T	N/A
V-150 Mariner		USA 6038681 - 0A904645	89-96054T	89-96158T	N/A
V-150	w/1/4-20 starter solenoid terminals	USA 0A904646 - 0C100860	89-96054T	89-96158T	N/A
V-150	w/5/16-18 starter solenoid terminals	USA 0A904646 - 0C100860	89-853654A 1	89-96158T	N/A
V-150		USA 0C100861 - 0C239552	89-853654A 1	89-96158T	N/A
V-150	w/standard color trim solenoid	USA 0C239553 - 0D081999	89-853654A 1	89-96158T	N/A
V-150	w/off white color trim solenoid	USA 0C239553 - 0D081999	89-853654A 1	89-818864T	N/A
V-150	w/flush mounted starter solenoid	USA 0D082000 - 0G201874	89-853654A 1	89-818997T 1	N/A
V-150	w/rubber bushing mount starter solenoid	USA 0D082000 - 0G201874	89-817109A 2	89-818997T 1	N/A
V-150	w/flush mounted starter solenoid	USA 0G201875 - 0G303045	89-853654A 1	N/A	882751A 1
V-150	w/rubber bushing mount starter solenoid	USA 0G201875 - 0G303045	89-817109A 2	N/A	882751A 1
V-150		USA 0G303046 and up	89-817109A 2	N/A	882751A 1
V-150 EFI	w/flush mounted starter solenoid	USA 0D082000 - 0G201874	89-853654A 1	89-818997T 1	N/A
V-150 EFI	w/rubber bushing mount starter solenoid	USA 0D082000 - 0G201874	89-817109A 2	89-818997T 1	N/A
V-150 EFI	w/flush mounted starter solenoid	USA 0G201875 - 0G303045	89-853654A 1	N/A	882751A 1
V-150 EFI	w/rubber bushing mount starter solenoid	USA 0G201875 - 0G303045	89-817109A 2	N/A	882751A 1
V-150 EFI		USA 0G303046 and up	89-817109A 2	N/A	882751A 1
V-150 DFI		USA 0G590000 and up	89-817109A 2	N/A	882751A 1
V-150 XR4		USA 0B242885 - 0C239552	89-853654A 1	89-96158T	N/A
V-150 XR4	w/standard color trim solenoid	USA 0C239553 - 0D081999	89-853654A 1	89-96158T	N/A
V-150 XR4	w/off white color trim solenoid	USA 0C239553 - 0D081999	89-853654A 1	89-818864T	N/A
V-150 XR6	w/flush mounted starter solenoid	USA 0D082000 - 0G201874	89-853654A 1	89-818997T 1	N/A
V-150 XR6	w/rubber bushing mount starter solenoid	USA 0D082000 - 0G201874	89-817109A 2	89-818997T 1	N/A
V-150 XR6	w/flush mounted starter solenoid	USA 0G201875 - 0G303045	89-853654A 1	N/A	882751A 1
V-150 XR6	w/rubber bushing mount starter solenoid	USA 0G201875 - 0G303045	89-817109A 2	N/A	882751A 1
V-150 XR6		USA 0G303046 and up	89-817109A 2	N/A	882751A 1
V-175 (V-175, V-1750)		USA 4301235 - 6618750	89-853654A 1	89-853654A 1	N/A
		AUS 8058870 and up			
V-175	w/1/4-20 starter solenoid terminals	USA 6618751 - 0C100860	89-96054T	89-96158T	N/A
V-175	w/5/16-18 starter solenoid terminals	USA 6618751 - 0C100860	89-853654A 1	89-96158T	N/A
V-175		USA 0C100861 - 0C239552	89-853654A 1	89-96158T	N/A
V-175	w/standard color trim solenoid	USA 0C239553 - 0D081999	89-853654A 1	89-96158T	N/A
V-175	w/off white color trim solenoid	USA 0C239553 - 0D081999	89-853654A 1	89-818864T	N/A

ELECTRICAL SYSTEM

Model	Model Notes	Serial # Range	Starter Solenoid	Power Trim Solenoid	Power Trim Relay
V-175	w/flush mounted starter solenoid	USA 0D082000 - 0G201874	89-853654A 1	89-818997T 1	N/A
V-175	w/rubber bushing mount starter solenoid	USA 0D082000 - 0G201874	89-817109A 2	89-818997T 1	N/A
V-175	w/flush mounted starter solenoid	USA 0G201875 - 0G303045	89-853654A 1	N/A	882751A 1
V-175	w/rubber bushing mount starter solenoid	USA 0G201875 - 0G303045	89-817109A 2	N/A	882751A 1
V-175		USA 0G303046 and up	89-817109A 2	N/A	882751A 1
V-175 EFI	w/standard color trim solenoid	USA 0D000750 - 0D081999	89-853654A 1	89-96158T	N/A
V-175 EFI	w/off white color trim solenoid	USA 0D000750 - 0D081999	89-853654A 1	89-818864T	N/A
V-175 EFI	w/flush mounted starter solenoid	USA 0D082000 - 0G201874	89-853654A 1	89-818997T 1	N/A
V-175 EFI	w/rubber bushing mount starter solenoid	USA 0D082000 - 0G201874	89-817109A 2	89-818997T 1	N/A
V-175 EFI	w/flush mounted starter solenoid	USA 0G201875 - 0G303045	89-853654A 1	N/A	882751A 1
V-175 EFI	w/rubber bushing mount starter solenoid	USA 0G201875 - 0G303045	89-817109A 2	N/A	882751A 1
V-175 EFI		USA 0G303046 - 0T800999	89-817109A 2	N/A	882751A 1
V-175 DFI		USA 0G960500 and up	89-817109A 2	N/A	882751A 1
V-175 Pro XS		USA 1B516339 and up	89-817109A 2	N/A	882751A 1
V-200 (V-200, V-2000)		USA 4839034 - 6073191	89-853654A 1	89-853654A 1	N/A
		AUS 8061595 - 8065672			
V-200		USA 6073192 - 6625220	89-96054T	89-96158T	N/A
V-200	w/1/4-20 starter solenoid terminals	USA 6625221 - 0C100860	89-96054T	89-96158T	N/A
V-200	w/5/16-18 starter solenoid terminals	USA 6625221 - 0C100860	89-853654A 1	89-96158T	N/A
V-200		USA 0C100861 - 0C291519	89-853654A 1	89-96158T	N/A
V-200 (2.5L)	w/standard color trim solenoid	USA 0C291520 - 0D081999	89-853654A 1	89-96158T	N/A
V-200 (2.5L)	w/off white color trim solenoid	USA 0C291520 - 0D081999	89-853654A 1	89-818864T	N/A
V-200	w/flush mounted starter solenoid	USA 0D082000 - 0G201874	89-853654A 1	89-818997T 1	N/A
V-200	w/rubber bushing mount starter solenoid	USA 0D082000 - 0G201874	89-817109A 2	89-818997T 1	N/A
V-200	w/flush mounted starter solenoid	USA 0G201875 - 0G303045	89-853654A 1	N/A	882751A 1
V-200	w/rubber bushing mount starter solenoid	USA 0G201875 - 0G303045	89-817109A 2	N/A	882751A 1
V-200		USA 0G303046 and up	89-817109A 2	N/A	882751A 1
V-200 EFI (2.4L)		USA 0C100861 - 0C291519	89-853654A 1	89-96158T	N/A
V-200 EFI (2.5L)	w/standard color trim solenoid	USA 0C291520 - 0D081999	89-853654A 1	89-96158T	N/A
V-200 EFI (2.5L)	w/off white color trim solenoid	USA 0C291520 - 0D081999	89-853654A 1	89-818864T	N/A
V-200 EFI	w/flush mounted starter solenoid	USA 0D082000 - 0G201874	89-853654A 1	89-818997T 1	N/A
V-200 EFI	w/rubber bushing mount starter solenoid	USA 0D082000 - 0G201874	89-817109A 2	89-818997T 1	N/A
V-200 EFI	w/flush mounted starter solenoid	USA 0G201875 - 0G303045	89-853654A 1	N/A	882751A 1
V-200 EFI	w/rubber bushing mount starter solenoid	USA 0G201875 - 0G303045	89-817109A 2	N/A	882751A 1
V-200 EFI		USA 0G303046 and up	89-817109A 2	N/A	882751A 1
V-200 DFI (3.0L)		USA 0G386496 and up	89-817109A 2	N/A	882751A 1
V-200 Pro XS		USA 1B504989 and up	89-817109A 2	N/A	882751A 1
V-220 Laser		USA 0B117316 and up	89-853654A 1	89-96158T	N/A
V-225 (2.4L)		USA 5628028 and up	89-853654A 1	89-853654A 1	N/A
V-225 (3.0L)		USA 0D280813 - 0G129221	89-817109A 2	89-818997T 1	N/A
V-225 (3.0L)	w/trim solenoids	USA 0G129222 - 0G303045	89-817109A 2	89-818997T 1	N/A
	w/trim relays	USA 0G129222 - 0G303045	89-817109A 2	N/A	882751A 1
V-225 (3.0L)		USA 0G303046 and up	89-817109A 2	N/A	882751A 1
V-225 Sea Pro/Marathon		USA 0G245605 and up	89-817109A 2	N/A	882751A 1
V-225 DFI		USA 0G590000 and up	89-817109A 2	N/A	882751A 1
V-225 Pro XS		USA 1B104549 and up	89-817109A 2	N/A	882751A 1
V-225/250 EFI		USA 0G129222 and up	89-817109A 2	N/A	882751A 1
V-250XB		USA 0G980600 and up	89-817109A 2	N/A	882751A 1
V-250 Pro XS		USA 1B426561 and up	89-817109A 2	N/A	882751A 1
V-250/275 (3.4L)		USA 0C101891 and up	89-853654A 1	89-96158T	N/A
V-300 (3.4L)		USA 5611648 and up	89-853654A 1	89-96158T	N/A

(1) 1/4-20 starter solenoid terminals require an 818998A 1 solenoid

ELECTRICAL HARNESS REPAIR COMPONENTS

ALTERNATOR HARNESS SERVICE END



84-881262A 2

As an alternative to replacing the complete engine harness, this service end is furnished with the necessary bullet connector to connect to the main engine harness.

OptiMax model year 1998 thru 2001, Delco alternator only.

CAN 1 HARNESS REPAIR KIT

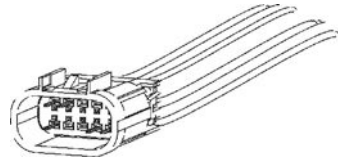

879346A31

Use when the replacement of an entire harness is not necessary. Includes the 10 pin connector and 5 crimp splices.

Fits the 75-115hp. EFI FourStroke outboard (1B366823-2B094995) the Optimax outboard and the L4/L6 Verado outboards. Also fits MCM CAN 1 resistors.

PACKARD REPAIR KIT, 2 PIN BLACK

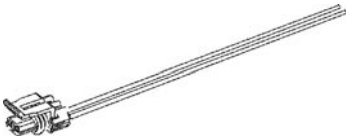

879346A32

Use when the replacement of an entire harness is not necessary. Includes the Packard 2-pin connector and 2 crimp splices.

Fits the 75-115hp. EFI FourStroke outboard (1B366823-2B094995)(temp sensors, vent canister switch and purge valve, neutral switch, trim relay harness), the Optimax outboard (neutral switch, temp sensors, IVST fuel pump, CAN 2 terminator) and the L4/L6 Verado (temp sensors, vent canister switch, vent vanister purge valve, knock resistor, neutral switch, water in fuel sensor, CAN 2 terminator). Also fits MCM 3.0L TKS temp switch, 3.0L MPI fuel pump, V-6 & SB V-8 exhaust water temp and 8.2L digital coolant sensor.

KNOCK SENSOR REPAIR KIT, 2-PIN, WHITE

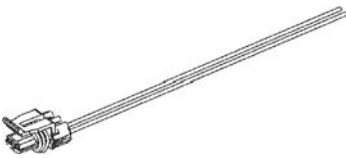

879346A33

Use when the replacement of an entire harness is not necessary. Includes the Packard 2-pin connector and 2 crimp splices.

Fits the L4/L6 Verado outboards. Also fits current MCM V-6 & V-8 knock sensors.

PACKARD REPAIR KIT, 3-PIN, BLACK

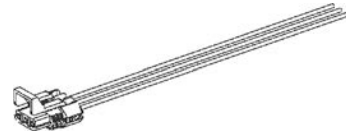

879346A34

Use when the replacement of an entire harness is not necessary. Includes the Packard 3-pin connector and 3 crimp splices.

Fits the L4/L6 Verado outboards (trim relay harness, power steering). Also fits MCM V-6 & SB V-8 cam position sensor.

PACKARD REPAIR KIT, 3-PIN GRAY

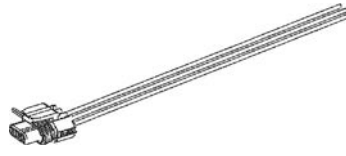

879346A35

Use when the replacement of an entire harness is not necessary. Includes the Packard 3-pin connector and 3 crimp splices.

Fits the 75-115hp. EFI FourStroke outboard (1B366823-2B094995)(MAP sensor) and the Optimax outboard (MAP Sensor). Also fits current MCM 8.2L MAP sensor.

PACKARD REPAIR KIT, 4-PIN



879346A36

Use when the replacement of an entire harness is not necessary. Includes the Packard 4-pin connector and 4 crimp splices.

Fits the 75-115hp. EFI FourStroke outboard (1B366823-2B094995)(diagnostics connector), the Optimax outboard (diagnostics connector) and the L4/L6 Verado outboards (diagnostics connector). Also fits MCM diagnostic/depth finder connector.

PACKARD REPAIR KIT, 5-PIN

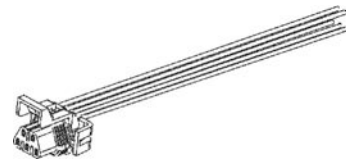

879346A37

Use when the replacement of an entire harness is not necessary. Includes the Packard 5-pin connector and 5 crimp splices.

Fits Optimax outboard (shift actuator) and the L4/L6 Verado outboard (shift actuator). Also fits MCM DTS digital shift actuator.

PACKARD REPAIR KIT, 6-PIN

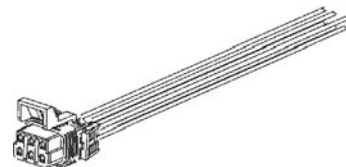

879346A38

Use when the replacement of an entire harness is not necessary. Includes the Packard 6-pin connector and 6 crimp splices.

Fits the 75-115hp. EFI FourStroke outboard (1B366823-2B094995)(SmartCraft boat harness, FSM harness), the Optimax outboard (SmartCraft boat harness) and the L4/L6 Verado outboard (SmartCraft boat harness, FSM harness). Also fits MCM paddle/fuel connector.

PACKARD REPAIR KIT, 3-PIN, ROUND

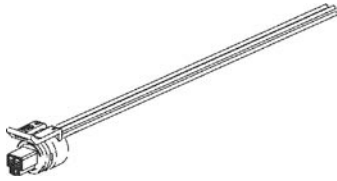

879346A39

Use when the replacement of an entire harness is not necessary. Includes the Packard 3-pin connector and 3 crimp splices.
Fits the 75-115hp. EFI FourStroke outboard (1B366823-2B094995)(MAP, pitot pressure, block water pressure, oil pressure, TPS throttle position), the Optimax outboard (block water pressure, pitot pressure) and the L4/L6 Verado outboard (MAP, pitot pressure, oil pressure, block pressure, 350ScI fuel rail pressure sensors). Also fits MCM V-6 & V-8 digital oil pressure sensor and 3.0L MPI TPS.

IGNITION COIL DRIVER REPAIR KIT, 2-PIN

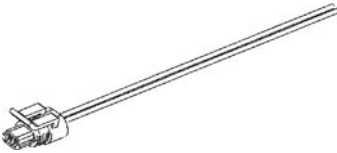

879346A40

Use when the replacement of an entire harness is not necessary. Includes the 2-pin connector and 2 crimp splices.
Fits the Optimax outboard (ignition coil driver). Also fits MCM digital coolant sensor.

DELPHI REPAIR KIT, 3-PIN

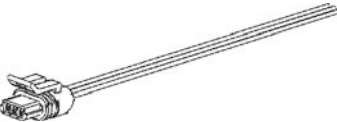

879346A41

Use when the replacement of an entire harness is not necessary. Includes the 3-pin connector and 3 crimp splices.
Fits the 75-115hp. EFI FourStroke outboard (1B366823-2B094995)(cam position sensor), the Optimax outboard (ignition coil, throttle position sensor) and the L4/L6 Verado outboard (cam position sensor). Also fits MCM 8.2L cam position sensor.

DELPHI REPAIR KIT, 4-PIN

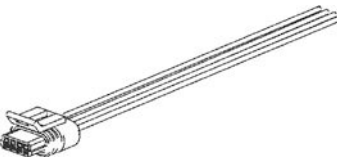

879346A42

Use when the replacement of an entire harness is not necessary. Includes the 4-pin connector and 4 crimp splices.
Fits the Optimax outboard (ignition coil driver). Also fits MCM V-6 & SB V-8 ignition coil driver.

BOOST VALVE REPAIR KIT, 4-PIN

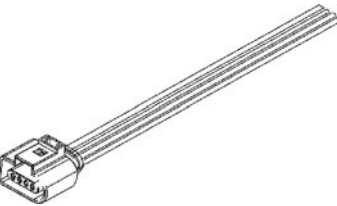

879346A43

Use when the replacement of an entire harness is not necessary. Includes the 4-pin connector and 4 crimp splices.
Fits the L4/L6 Verado outboards (boost valve).

ETC ELECTRONIC THROTTLE REPAIR KIT, 6-PIN

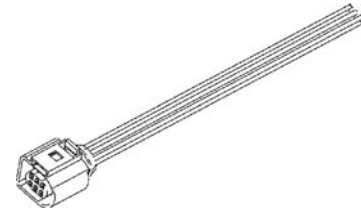

879346A44

Use when the replacement of an entire harness is not necessary. Includes the 6-pin connector and 6 crimp splices.
Fits the Optimax outboard (ETC electronic throttle control) and the L4/L6 Verado outboard (ETC electronic throttle control). Also fits MCM DTS digital throttle.

MAT MANIFOLD AIR TEMPERATURE REPAIR KIT, 2-PIN

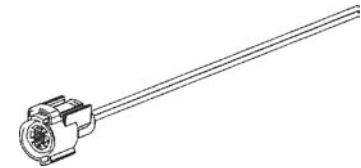

879346A45

Use when the replacement of an entire harness is not necessary. Includes the MAT 2-pin connector and 2 crimp splices.
Fits the 75-115hp. EFI FourStroke outboard (1B366823-2B094995)(MAT sensor) and the L4/L6 Verado outboard (MAT sensor).

PENCIL COIL REPAIR KIT, 3-PIN

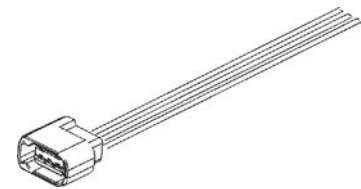

879346A46

Use when the replacement of an entire harness is not necessary. Includes the 3-pin connector and 3 crimp splices.
Fits the 75-115hp. EFI FourStroke outboard (1B366823-2B094995)(pencil coil) and the L4/L6 Verado outboard (pencil coil).

HARNESS REPAIR KIT, 3-PIN

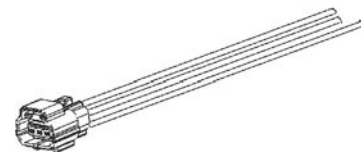

879346A47

Use when the replacement of an entire harness is not necessary. Includes the cowl switch connector and 3 crimp splices.
Fits the 75-115hp. EFI FourStroke outboard (1B366823-2B094995)(cowl tilt switch), the Optimax outboard (cowl tilt switch) and the L4/L6 Verado outboard (cowl tilt switch, trim sensor harness).

ELECTRICAL SYSTEM

RELAY BASE REPAIR KIT, WHITE

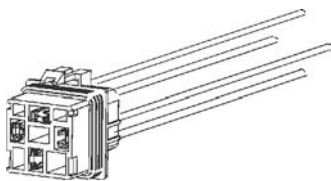

879346A48

Use when the replacement of an entire harness is not necessary. Includes the relay base connector and 4 crimp splices.

Fits the 75-115hp. EFI FourStroke outboard (1B366823-2B094955)(main power relay), the Optimax outboard (main power relay) and the L4/L6 Verado outboard (fuel pump relay, starter relay). Alos fits MCM starter relay and main power relay.

DIRECT INJECTOR HARNESS SERVICE END

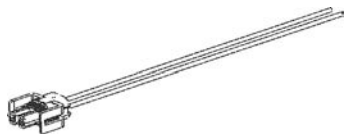

879346A49

As an alternative to replacing the complete engine harness, this service end is furnished with the necessary 2 bullet connectors to connect to the main engine harness.

Fits the Optimax outboard (direct injector).

FUEL INJECTOR HARNESS SERVICE END

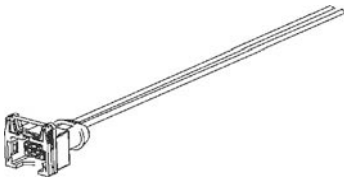

879346A50

As an alternative to replacing the complete engine harness, this service end is furnished with the necessary 2 bullet connectors to connect to the main engine harness.

Fits the 75-115hp. EFI FourStroke outboard (1B366823-2B094955)(fuel injector), the Optimax outboard (fuel injector) and the L4/L6 Verado outboard (fuel injector). Alos fits the current 8.2L injectors.

IGNITION COIL REPAIR KIT, 5-PIN

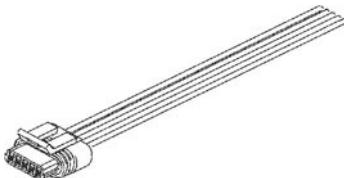

879346A51

Use when the replacement of an entire harness is not necessary. Includes the 5-pin connector and 5 crimp splices.

Fits the Optimax outboard (ignition coil).

CPS CRANKSHAFT POSITION SENSOR REPAIR KIT, 2-PIN

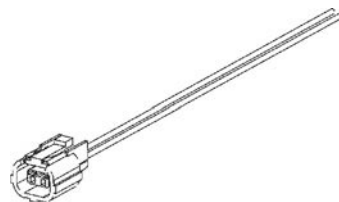

879346A52

Use when the replacement of an entire harness is not necessary. Includes the CPS 2-pin connector and 2 crimp splices.

Fits the 75-115hp. EFI FourStroke outboard (1B366823-2B094955)(crankshaft position sensor), the Optimax outboard (crankshaft position sensor) and the L4/L6 Verado outboard (crankshaft position sensor). Alos fits the 3.0L MPI crankshaft position sensor.

ALTERNATOR REPAIR KIT, 2-PIN

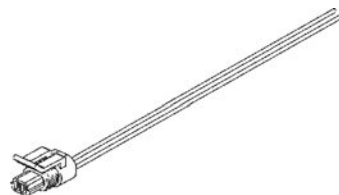

879346A53

Use when the replacement of an entire harness is not necessary. Includes the alternator 2-pin connector and 2 crimp splices.

Fits the 75-115hp. EFI FourStroke outboard (1B366823-2B094955), the Optimax outboard and the L4/L6 Verado outboard.

IAC REPAIR KIT, 2-PIN



8M0050085

As an alternative to replacing the complete engine harness, this service end is furnished with the necessary 2 bullet connectors to connect to the main engine harness.

Fits MCM MPI engines with mechanical throttle body. Also fits the 75-115hp. EFI FourStroke outboard (1B366823-2B094955)(Idle air control IAC).

DTS POWER HARNESS REPAIR KIT, 2-PIN

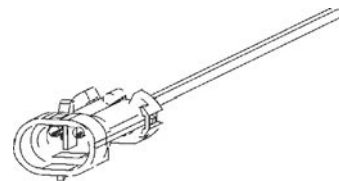

8M0050324

As an alternative to replacing the complete engine harness, this service end is furnished with the necessary 2 bullet connectors to connect to the main engine harness.

Fits the Optimax outboard (DTS power harness).

CRANK SENSOR HARNESS SERVICE END



84-878074A 2

As an alternative to replacing the complete engine harness, this service end is furnished with the necessary bullet connector to connect to the main engine harness.

OptiMax model year 2000 and prior.

ELECTRICAL HARNESS SEAL KIT

Electrical harness seals found in a variety of Optimax, DFI and EFI applications may be purchased in kit form or ordered separately.

IGNITION COIL HARNESS SEAL



26-878461 3

Green, 3-way.

Priced individually, sold @ multiples of 2

MAP SENSOR HARNESS SEAL



26-878463 3

Purple, 3-way.

Priced individually, sold @ multiples of 2

CDM HARNESS SEAL



26-878461 4

Light blue, 4-way.

Priced individually, sold @ multiples of 2

TEMPERATURE SENDER HARNESS SEAL



26-878463 2

Gray, 2-way.

Priced individually, sold @ multiples of 2

DDT HARNESS SEAL



26-878466

Green, 2-way.

Priced individually, sold @ multiples of 2

OIL PUMP HARNESS SEAL



26-878461 2

Light Blue, 2-way.

Priced individually, sold @ multiples of 2

DIRECT INJECTOR HARNESS SEAL



26-878462

Light Blue, 2-way.
Priced individually, sold @ multiples of 2

FUSE HARNESS SEAL



26-878464 8

Green, 8-way.
Priced individually, sold @ multiples of 2

FUEL PUMP HARNESS SEAL



26-878464 2

Green, 2-way.
Priced individually, sold @ multiples of 2

SS-V6 HARNESS SEAL



26-878463 6

Light Blue, 6-way.
Priced individually, sold @ multiples of 2

RELAY HARNESS SEAL



26-878465

Green, 5-way.
Priced individually, sold @ multiples of 2

STATOR HARNESS SEAL



26-878463 4

Tan, 4-way.
Priced individually, sold @ multiples of 2

FUSE HARNESS SEAL



26-878464 6

Green, 6-way.
Priced individually, sold @ multiples of 2

FUEL SYSTEM

CHECK VALVE KITS

CHECK VALVE KIT



21- 30430A 2

See application chart

CHECK VALVE KIT



21- 8M0084275

Kit contains fuel pump diaphragms, gaskets, check valves, spring, cap and screws. Filler blocks are no longer available.

CHECK VALVE KIT

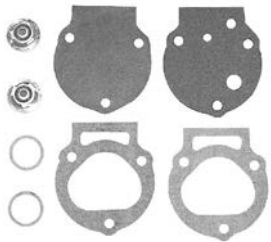

21- 30430A 1

See application chart

CHECK VALVE KIT



21- 30430A 3

See application chart

CHECK VALVE KIT



21- 8M0084276

Kit contains fuel pump diaphragms, gaskets, check valves, spring, cap and screws. Filler blocks are no longer available.

CHECK VALVE KIT

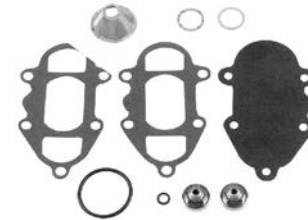

21- 30430A 7

See application chart

CHECK VALVE KIT



21- 8M0084277

Kit contains fuel pump diaphragms, gaskets, check valves, inlet screen, pulse chamber, spring, cap and screws. Filler blocks are no longer available.

CHECK VALVE KIT



21- 30430A 8

See application chart

FUEL PUMP DIAPHRAGM KITS

FUEL PUMP DIAPHRAGM



80606M

Yamaha part number, 648-24411-00-00

FUEL PUMP DIAPHRAGM

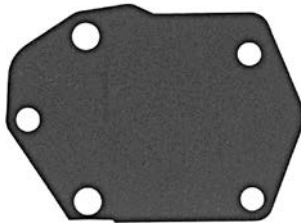

84141M

Yamaha part number, 663-24411-00-00

GASKET



27-98769 1

Fits a wide variety of Mercury 2 stroke outboard engines. See dealer for applications.

DIAPHRAGM KIT

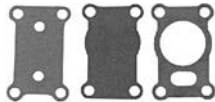

31503A 1

See application chart

Priced individually, sold @ multiples of 5

DIAPHRAGM & GASKET KIT



1395-9761 1

See application chart

DIAPHRAGM KIT

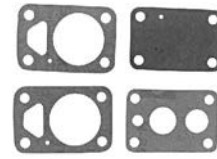

53245A 1

Diaphragm kit

DIAPHRAGM KIT

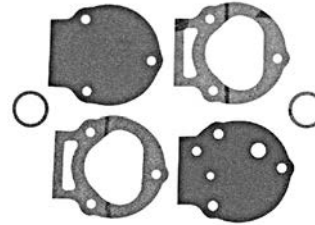

23014A 1

See application chart

DIAPHRAGM KIT



21-857005A 1

See application chart

DIAPHRAGM KIT



55278A 1

See application chart

DIAPHRAGM KIT



55278A 4

See application chart
Priced individually, sold @ multiples of 5

DIAPHRAGM KIT

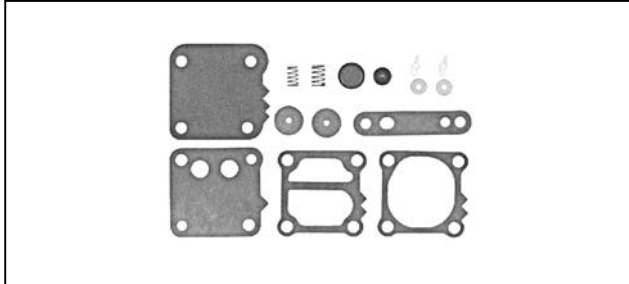

42909A 4

See application chart

DIAPHRAGM KIT



55278A 5

See application chart

DIAPHRAGM KIT

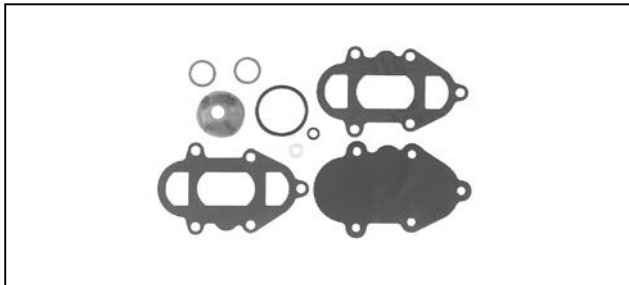

89031A 1

See application chart
Priced individually, sold @ multiples of 2

DIAPHRAGM KIT

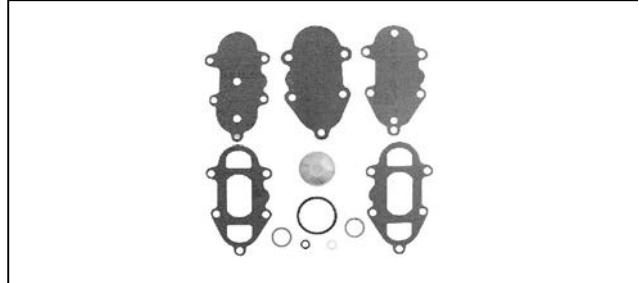

89031A 3

See application chart
Priced individually, sold @ multiples of 2

DIAPHRAGM KIT



89031A 2

See application chart
Priced individually, sold @ multiples of 2

DIAPHRAGM KIT



90363A 1

See application chart

DIAPHRAGM KIT



89031A 4

See application chart

FUEL SYSTEM

MECHANICAL FUEL PUMP ASSEMBLY



835389T02

Sold as a complete assembly.
Fits the F8/9.9/13.5/15 Hp. FourStroke 323cc. outboards.

DIAPHRAM KIT



21-851812A01

See application chart

FUEL PUMP ASSEMBLY

Image not Available.

8M0141827

Sold as complete pump only.
Fits the 40 hp. FourStroke (3 cylinder Carb model) s/n USA 1B036614-1B344306 and CHN 1C000001 and above, 40 hp. FourStroke (3 cylinder EFI model) s/n USA 0T409000 and above and CHN 1C000001 and above, and the 40/50/60 hp. (4 cylinder EFI model) s/n USA 0T409000 and above and CHN 1C000001 and above.

MECHANICAL FUEL PUMP REPAIR CHART

Mercury/Mariner Fuel Pump Repair Kits

Model	Serial # Range	Check Valve Kit	Diaphragm Kit	Mechanical Fuel Pump
3.9	1655013 - 2498135	N.L.A.	31503A 1	N.L.A.
4 (40)(1 cyl)	USA 2498136 - 4107219	21-30430A 2	53245A 1	89977A 1
	AUS 3306257 - 8026539			
	BEL 9000306 - 90721718			
	CAN 3305152 - 7045757			
4 FourStroke	JPN 0R036272 and up	N/A	21-851812A01	803529T06
	BEL 0P401000 and up			
4.5 (45, 4.5)(1 cyl)	USA 4107220 - 5270783	21-30430A 2	53245A 1	89977A 1
	AUS 8026540 - 8059344			
	BEL 9072179 - 9221755			
	CAN 7045758 - 7128837			
5 FourStroke	JPN 0R036272 and up	N/A	21-851812A01	803529T06
	BEL 0P401000 and up			
6 (60)	1916139 - 2529894	N.L.A.	31503A 1	N.L.A.
6 (60J)	2385673 - 2387383	N.L.A.	31503A 1	N.L.A.
6	USA 0A197112 - 0T800749	N/A	1395- 9761 1	N/A
	BEL 9461526 and up			
6 FourStroke	JPN 0R036272 and up	N/A	21-851812A01	803529T06
	BEL 0P401000 and up			
7.5 (75)	2529895 - 3488152	21-30430A 2	53245A 1	89977A 1
8	USA 0A197112 and up	N/A	1395- 9761 1	N/A
	BEL 9461526 and up			

Model	Serial # Range	Check Valve Kit	Diaphragm Kit	Mechanical Fuel Pump
9.8 (110)	1865779 - 27980563	N.L.A.	31503A 1	N.L.A.
9.8 (110)	2798057 - 3795657	21- 30430A 2	53245A 1	89977A 1
9.9	USA 0A197112 and up BEL 9461526 and up	N/A	1395- 9761 1	N/A
9.9 FourStroke 232cc	USA 0H000058 - 0H016909	N/A	N/A	N.L.A.
9.9 FourStroke 323cc	USA 0G760300 - 1B226999 BEL 0P075166 - 0P400999	N/A	N/A	835389T02
9.9 FourStroke	JPN 0R042475 and up BEL 0P325500 and up	N/A	21- 851812A01	803529T06
15	USA 0B292414 and up BEL 9542620 and up	N/A	1395- 9761 1	N/A
15 FourStroke	USA 0G590000 - 1B727495	N/A	N/A	835389T02
15 FourStroke	JPN 0R235949 and up	N/A	N/A	803529T04
20 (200)	1866496 - 2296266	21- 30430A 2	23014A 1	N.L.A.
20 (200)	2296267 - 2551114	N.L.A.	N.L.A.	N.L.A.
20 (200)	2551115 - 3537530	21- 30430A 2	53245A 1	89977A 1
20	USA 6443973 - 0T800749 BEL 9415101 and up CAN 7209533 and up	N/A	1395- 9761 1	N/A
20 FourStroke	JPN 0R235168 and up	N/A	N/A	803529T04
20 JET	USA 0G044027 and up	N/A	1395- 9761 1	N/A
25	USA 6443973 and up BEL 9415101 and up CAN 7209533 and up	N/A	1395- 9761 1	N/A
25 FourStroke (Carb)	USA 0G590000 - 0T40899 BEL 9973100 - 0P153499	N/A	N/A	826398T 3
25 FourStroke (Carb)	USA 0T409000 - 1B344298 BEL 0P153500 - 0P388282	N/A	N/A	899106T
25 FourStroke (EFI)	JPN 0R106999 and up	N/A	N/A	803529T04
30 (2 cyl)(644cc)	0G053314 - 0T800749	N/A	21- 857005A 1	14360A78
30 JET	0C159200 - 0T408999	N/A	21- 857005A 1	14360A78
30 FourStroke	USA 0G760300 - 0T408999 BEL 0P017000 - 0P153499	N/A	N/A	826398T 3
30 FourStroke	USA 0T409000 - 1B226999 BEL 0P153500 - 0P400999	N/A	N/A	899106T
30 FourStroke	JPN 0R106999 and up	N/A	N/A	803529T04
35 (350)	1960827 - 2874703	21- 30430A 1	23014A 1	N.L.A.
35	USA 6445653 - 0B110788 BEL 9384476 - 9466646 CAN 7209608 and up	21- 8M0084275	55278A 4	N.L.A.
35	USA 0B110789 and up BEL 9466647 and up	N/A	21- 857005A 1	14360A78
40 (40, 400, 402)(2 cyl)	USA 2874704 - 5556229 AUS 8002335 - 8064749 BEL 3339688 - 9251455 CAN 3340783 - 7144762	21- 30430A 3	55278A 1	N.L.A.
40 (2 cyl)(644cc)	USA 0G053314 and up	N/A	21- 857005A 1	14360A78
40 (4 cyl)	USA 0C159200 and up BEL 9570790 and up	N/A	21- 857005A 1	14360A78
40 (3 cyl)	USA 0G590000 - 0T999999 BEL 9973100 and up	N/A	21- 857005A 1	14360A78
40 FourStroke (3 cyl., Carb)	USA 0T409000 - 1B036613	N/A	8M0141827	899106T

Not all parts listed are available for the European, C.I.S., Africa and Middle East Markets.
For more information, please contact your local Mercury, Mariner, MerCruiser or Quicksilver Office.

FUEL SYSTEM

MERCURY® OUTBOARDS

Model	Serial # Range	Check Valve Kit	Diaphragm Kit	Mechanical Fuel Pump
40 FourStroke (3 cyl., Carb)	USA 1B036614 - 1B344306	N/A	N/A	8M0141827
	CHN 1C000001 and up			
40 FourStroke (3 cyl., EFI)	USA 0T409000 - 1B344398	N/A	N/A	8M0141827
	BEL 0P153500 - 0P515896			
	CHN 1C000001 and up			
40 FourStroke (4 cyl., Carb)	USA 0T178500 - 0T598999	N/A	N/A	826398T 3
	BEL 0P094500 - 0P206999			
40 FourStroke (4 cyl., EFI)	USA 0T409000 - 1B344306	N/A	N/A	8M0141827
	BEL 0P153500 and up			
	CHN 1C000001 and up			
40 JET (2 cycle)	USA 0G760300 and up	N/A	21-857005A 1	14360A78
	BEL 0P017000 and up			
40 FourStroke JET	CHN 1C051324 and up	N/A	N/A	8M0141827
45 (4 cyl)	USA 0B110789 and up	N/A	21-857005A 1	14360A78
	BEL 9466692 and up			
45 JET	USA 0D000750 - 0T129554	N/A	21-857005A 1	14360A78
	BEL 9683055 - 0P094499			
50 (50, 500)(4 cyl)	USA 2116318 - 4357639	21-30430A 2	23014A 1	N.L.A.
	AUS 2863739 - 8030089			
	BEL 9001581 - 9107213			
	CAN 2097445 - 7068997			
50 (3 cyl)	USA 6428681 - 0B122929	N/A	55278A 1	N.L.A.
	BEL 9385911 - 9469199			
	CAN 7208333 - 0A721307			
50 (3 cyl)	USA 0B122930 - 0T999999	N/A	21-857005A 1	14360A78
	BEL 9469200 and up			
	CAN 0A721308 and up			
50 FourStroke (Carb)	USA 0G231123 - 0T598999	N/A	N/A	826398T 3
	BEL 9944807 - 0P206999			
50 FourStroke (EFI)	USA 0T409000 - 1B226999	N/A	N/A	8M0141827
	BEL 0P153500 - 0P400999			
	CHN 1C000001 and up			
55 (3 cyl)	USA 0D000750 and up	N/A	21-857005A 1	14360A78
	BEL 9741042 and up			
60 (3 cyl)	USA 6428681 - 0B122929	N/A	55278A 1	N.L.A.
	BEL 9385911 - 9469199			
	CAN 7208333 - 0A721307			
60 (3 cyl)	USA 0B122930 and up	N/A	21-857005A 1	14360A78
	BEL 9469200 and up			
	CAN 0A721308 and up			
60 FourStroke (Carb)	USA 0T178500 - 0T598999	N/A	N/A	826398T 3
	BEL 0P094500 - 0P206999			
60 FourStroke (EFI)	USA 0T409000 - 1B226999	N/A	N/A	8M0141827
	BEL 0P153500 - 0P400999			
	CHN 1C000001 and up			
65 (650)(4 cyl)	2119749 - 2803561	21-30430A 1	23014A 1	N.L.A.
65 (650)(4 cyl)	2803562 - 3293183	N.L.A.	N.L.A.	N.L.A.
65 (650)(3 cyl)	USA 3293184 - 4571651	21-30430A 3	N.L.A.	N.L.A.
	AUS 8006640 and up			
	BEL 9020074 - 9135824			
	CAN 7013633 - 7087822			
65 JET	USA 0D283222 and up	N/A	21-857005A 1(2)	14360A78

Model	Serial # Range	Check Valve Kit	Diaphragm Kit	Mechanical Fuel Pump	
70 (3 cyl)	USA	4571652 - 6428680	21-8M0084275	55278A 4	N.L.A.
	AUS	8042350 and up			
	BEL	9135825 - 9385910			
	CAN	7087823 - 7208332			
70 (3 cyl)	USA	0A996142 - 0C221999	N/A	42909A 4	14360A78
	BEL	9483121 - 9589038			
75 (4 cyl)	USA	6432901 and up	21-8M0084276(4)	55278A 5	N.L.A.(4)
	BEL	9393856 and up			
	CAN	7208573 and up			
75 (4 cyl)	USA	6432901 and up	N/A	21-857005A 1(3)	14360A78(3)
	BEL	9393856 and up			
	CAN	7208573 and up			
75 (3 cyl)	USA	0C222000 - 0D283221	N/A	42909A 4(1)	14360A78
	BEL	9589039 - 9793576			
75 (3 cyl)	USA	0C222000 - 0D283221	N/A	21-857005A 1(2)	14360A78
	BEL	9589039 - 9793576			
75 (3 cyl)	USA	0D283222 and up	N/A	21-857005A 1	14360A78
	BEL	9793577 and up			
75 DFI (3 cyl)	USA	0T980000 and up	N/A	21-857005A 1	14360T74
75 FourStroke (Carb)	USA	0G960500 - 0T408999	N/A	N/A	804249T 1
75 FourStroke (Carb)	USA	0T409000 - 1B226999	N/A	N/A	880890T 1
75 FourStroke (EFI)	USA	1B172291 - 1B366822	N/A	N/A	880890A02
80 (800)(4 cyl)		2559001 - 2670574	21-30430A 1	23014A 1	N.L.A.
80 (800)(4 cyl)		2783253 - 2856331	21-30430A 3	N.L.A.	N.L.A.
80 (800)(4 cyl)		2886332 - 3493912	21-8M0084276	55278A 5	N.L.A.
80 (80, 800)(4 cyl)	USA	4831999 - 6432900	21-8M0084276	55278A 5	N.L.A.
	AUS	8050200 and up			
	BEL	9177626 - 9393855			
	CAN	7110998 - 7208572			
80 (3 cyl)	USA	0A996142 - 0C221999	N/A	42909A 4	14360A78
	BEL	9483121 - 9589038			
80 JET (4 cyl.)	USA	0D283222 and up	N/A	21-857005A 1	14360A78
	BEL	9793577 - 0P325499			
80 JET (3 cyl.)	USA	1B586067 and up	N/A	21-857005A 1	14360T74
85 (850)(4 cyl)	USA	3493913 - 4831998	21-8M0084276	55278A 5	N.L.A.
	AUS	8005440 - 8050199			
	BEL	9011604 - 9177625			
	CAN	7010108 - 7110997			
90 (90, 900)(6 cyl)	USA	4845301 - 5299505	21-30430A 7	89031A 1	N.L.A.
	CAN	7111698 - 7123762			
90 (6 cyl)	USA	5299506 - 6436122	21-8M0084277	89031A 3	N.L.A.
	AUS	8060545 and up			
	CAN	7147088 - 7208847			
90 (6 cyl)	USA	6436123 and up	N/A	21-857005A 1(3)	14360A78(3)
	CAN	7208848 and up			
90 (3 cyl)	USA	0A996142 - 0C221999	N/A	42909A 4	14360A78
	BEL	9483121 - 9589038			
90 (3 cyl)	USA	0C222000 - 0D283221	N/A	21-857005A 1(2)	14360A78
	BEL	9589039 - 9793576			
90 (3 cyl)	USA	0C222000 - 0D283221	N/A	42909A 4(1)	14360A78
	BEL	9589039 - 9793576			
90 (3 cyl)	USA	0D283222 and up	N/A	21-857005A 1	14360A78
	BEL	9793577 and up			

FUEL SYSTEM

MERCURY® OUTBOARDS

Model	Serial # Range	Check Valve Kit	Diaphragm Kit	Mechanical Fuel Pump
90 DFI (3 cyl)	USA 0T801000 and up	N/A	21-857005A 1	14360T74
90 FourStroke (Carb)	USA 0G960500 - 0T408999	N/A	N/A	804249T 1
90 FourStroke (Carb)	USA 0T409000 - 1B226999	N/A	N/A	880890T 1
90 FourStroke (EFI)	USA 1B172291 - 1B366822	N/A	N/A	880890A02
95 (950)(6 cyl)	1869776 - 2318585	21-30430A 1	23014A 1	N.L.A.
100 (1000SS/BP)(6 cyl)	2318586 - 3253111	21-30430A 1	23014A 1	N.L.A.
100 (4 cyl)	USA 0B209468 - 0D283221	N/A	42909A 4(1)	14360A78
	BEL 9523034 - 9793576			
100 (4 cyl)	USA 0B209468 - 0D283221	N/A	21-857005A 1(2)	14360A78
	BEL 9523034 - 9793576			
100 (4 cyl)	USA 0D283222 - 0G965520	N/A	21-857005A 1	14360A78
	BEL 9793577 - 0P058999			
110 (1100)(6 cyl)	1870204 - 2314955	21-30430A 1	23014A 1	N.L.A.
115 (1150)(6 cyl)	USA 2836019 - 3761034	21-30430A 3	55278A 1	N.L.A.
	AUS 8008665 - 8014004			
	CAN 7010763 - 7025597			
115 (115, 1150)(6 cyl)	USA 3761035 - 5314655	21-30430A 7	89031A 1	N.L.A.
	AUS 8014005 - 8061119			
	CAN 7025598 - 7131212			
115 (115, 1150)(6 cyl)	USA 5314656 - 6436122	21-8M0084277	89031A 3	N.L.A.
	AUS 8061120 and up			
	CAN 7131213 - 7208847			
115 (115, 1150)(6 cyl)	USA 6436123 and up	21-8M0084277(4)	89031A 3(4)	N.L.A.
	CAN 7208848 and up			
115 (115, 1150)(6 cyl)	USA 6436123 and up	N/A	21-857005A 1(3)	14360A78
	CAN 7208848 and up			
115 (4 cyl)	USA 0D283222 and up	N/A	21-857005A 1	14360A78
	BEL 9793577 and up			
115 DFI (6 cyl)	USA 0G960500 - 0T178999	N/A	21-857005A 1	14360T75
115 DFI (3 cyl)	USA 0T801000 and up	N/A	21-857005A 1	14360T74
115 Pro XS	USA 1B751825 and up	N/A	21-857005A 1	14360T74
115 FourStroke (EFI)	USA 0T178500 - 1B366822	N/A	N/A	880890T 1
125 (1250)(6 cyl)	2314956 - 2839368	21-30430A 1	23014A 1	N.L.A.
125 (1250BP)(6 cyl)	2400058 - 2641954	21-30430A 1	23014A 1	N.L.A.
125 (4 cyl)	USA 0D283222 and up	N/A	21-857005A 1	14360A78
	BEL 9793577 and up			
125 DFI (3 cyl)	USA 1B736885 and up	N/A	21-857005A 1	14360T74
135 (1350)(6 cyl)	2839369 - 3293233	21-30430A 3	55278A 1	N.L.A.
140 (1400)(6 cyl)	3293234 - 3502805	21-30430A 3	55278A 1	N.L.A.
140 (140, 1400)(6 cyl)	USA 4865678 - 5327662	21-30430A 7	89031A 1	N.L.A.
	AUS 8052650 - 8052879			
	CAN 7112773 - 7132512			
140 (6 cyl)	USA 5327663 and up	21-8M0084277	89031A 3	N.L.A.
	AUS 8066065 and up			
	CAN 7132513 and up			
140 JET	USA 0G303046 - 0T178499	N/A	21-857005A 1	14360A78
150 (1500)(6 cyl)	USA 3502806 - 4865677	21-30430A 3	55278A 1	N.L.A.
	AUS 8005615 - 8052649			
	CAN 7010533 - 7112772			
150 (1500XS)(6 cyl)	USA 4868648 - 5327662	21-30430A 8	89031A 2	N.L.A.
V-135	USA 0A904646 - 0C100860	21-30430A 8(4)	89031A 2(4)	N.L.A.(4)
V-135	USA 0A904646 - 0D081999	N/A	21-857005A 1(3)	15930A15
V-135	USA 0D082000 - 0T178499	N/A	21-857005A 1	14360A78
V-135 DFI (Design I)	USA 0G590000 - 0G760299	N/A	N/A	N.L.A.

Model	Serial # Range	Check Valve Kit	Diaphragm Kit	Mechanical Fuel Pump
V-135 DFI (Design II)	USA 0G590000 - 0G760299	N/A	21-857005A 1	14360T75
V-135 DFI	USA 0G760300 and up	N/A	21-857005A 1	14360T75
V-1500 (150hp)	USA 4868998 - 0A904645	21- 30430A 8	89031A 2	N.L.A.
V-150	USA 0A904646 - 0C100860	21- 30430A 8(4)	89031A 2	N.L.A.
V-150	USA 0A904646 - 0C100860	N/A	21-857005A 1(3)	15930A15
V-150	USA 0C100861 - 0D081999	N/A	21-857005A 1	15930A15
V-150 (Carb & EFI)	USA 0D082000 - 1B226999	N/A	21-857005A 1	14360A78
V-150 DFI (Design I)	USA 0G590000 - 0G760299	N/A	21-857005A 1	N.L.A.
V-150 DFI (Design II)	USA 0G590000 - 0G760299	N/A	21-857005A 1	14360T75
V-150 DFI	USA 0G760300 and up	N/A	21-857005A 1	14360T75
XR-4	USA 0B242885 - 0D081999	N/A	21-857005A 1	15930A15
XR-6	USA 0D082000 and up	N/A	21-857005A 1	14360A78
V-175	USA 4301235 - 0C100860	21- 30430A 8(4)	89031A 2(4)	N.L.A.
	AUS 8058870 and up			
V-175	USA 4301235 and up	N/A	21-857005A 1(3)	
	AUS 8058870 and up			
V-175	USA 0C100861 - 0D303045	N/A	21-857005A 1	15930A15
V-175	USA 0D303046 - 0G960499	N/A	21-857005A 1	14360A78
V-175 EFI	USA 0D000750 - 0D081999	N/A	21-857005A 1	15930A15
V-175 EFI	USA 0D082000 - 0T408999	N/A	21-857005A 1	14360A78
V-175 EFI	USA 0T409000 - 0T800999	N/A	21-857005A 1	14360T75
V-175 DFI	USA 0T178500 and up	N/A	21-857005A 1	14360T75
V-175 Pro XS	USA 1B516339 and up	N/A	21-857005A 1	14360T75
V-200, V-2000	USA 4839034 - 6073191	21- 30430A 8	89031A 2	N.L.A.
	AUS 8061595 - 8065672			
V-200	USA 6073192 - 6357229	N.L.A.	90363A 1	N.L.A.
V-200	USA 6357230 - 6625220	N.L.A.	89031A 4	N.L.A.
V-200	USA 6625221 - 0C291519	N/A	21-857005A 1	15930A15
V-200	USA 0C291520 - 1B226999	N/A	21-857005A 1	14360A78
V-200 EFI	USA 0C100861 - 0D081999	N/A	21-857005A 1	15930A15
V-200 EFI	USA 0D082000 - 0T408999	N/A	21-857005A 1	14360A78
V-200 EFI (2.5L)	USA 0T409000 and up	N/A	21-857005A 1	14360T75
V-200 EFI (3.0L)	USA 0T750164 and up	N/A	21-857005A 1	14360A78
V-200 DFI	USA 0G590000 - 0T598999	N/A	21-857005A 1	14360A78
V-200 DFI	USA 0T599000 - 0T800999	N/A	21-857005A 1	14360T77
V-200 DFI	USA 0T801000 and up	N/A	21-857005A 1	14360T74
V-200 Pro XS	USA 1B504989 and up	N/A	21-857005A 1	14360T74
V-220 LASER	USA 0B117316 and up	N/A	21-857005A 1	15930A15
V-225	USA 5628028 and up	N.L.A.	90363A 1	N.L.A.
V-225/225 SEA-PRO/ MARTHON (3.0L)	USA 0D280813 and up	N/A	21-857005A 1	14360A78
V-225 EFI (3.0L)	USA 0G129222 and up	N/A	21-857005A 1	14360A78
V-225 DFI	USA 0G590000 - 0T598999	N/A	21-857005A 1	14360A78
V-225 DFI	USA 0T599000 - 0T800999	N/A	21-857005A 1	14360T77
V-225 DFI	USA 0T801000 and up	N/A	21-857005A 1	14360T74
V-225 DTS	USA 0T599000 - 1B417701	N/A	21-857005A 1	14360T77
V-225 DTS	USA 1B417702 and up	N/A	21-857005A 1	14360T74
V-225 Pro XS	USA 1B104549 and up	N/A	21-857005A 1	14360T74
V-250 (3.4L)	USA 0C101891 and up	N/A	21-857005A 1	14360A78
V-250 EFI (3.0L)	USA 0G129222 and up	N/A	21-857005A 1	14360A78
V-250XB	USA 0G980600 - 0T800999	N/A	21-857005A 1	14360A78
V-250 DFI	USA 1B528615 and up	N/A	21-857005A 1	14360T74
V-250 Pro XS	USA 1B426561 and up	N/A	21-857005A 1	14360T74
V-275 (3.4L)	USA 0C101891 and up	N/A	21-857005A 1	14360A78

Not all parts listed are available for the European, C.I.S., Africa and Middle East Markets.
For more information, please contact your local Mercury, Mariner, MerCruiser or Quicksilver Office.

FUEL SYSTEM

MERCURY® OUTBOARDS

Model	Serial # Range	Check Valve Kit	Diaphragm Kit	Mechanical Fuel Pump
V-300 (3.4L)	USA 5611648 and up	21-30430A 8	89031A 2	N.L.A.

- (1) 90 Degree Oil Check Valve
- (2) Inline Oil Check Valve
- (3) Use With Square Fuel Pump
- (4) Use With Triangular Fuel Pump

CARBURETOR GASKETS & GASKET KITS

FLOAT BOWL COVER GASKET



1399- 99

Priced individually, sold @ multiples of 10

GASKET

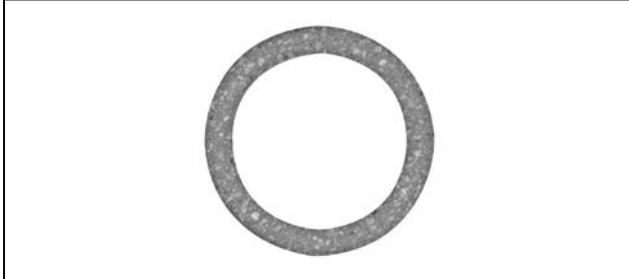

1399- 5207

Fits various Mercury 2 stroke carburetors
Priced individually, sold @ multiples of 3

GASKET

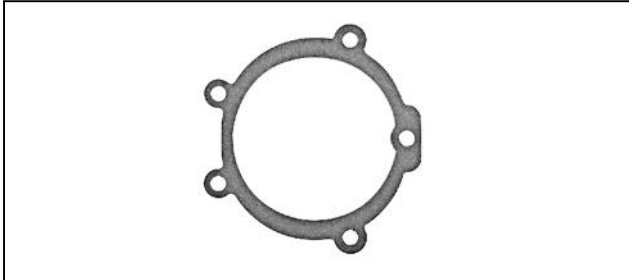

27- 13937 6

Fits Various 75-115 horsepower 2 stroke outboard engines. See dealer for application

GASKET



27- 15172 4

See dealer for applications

GASKET



27- 25848

Priced individually, sold @ multiples of 5
Priced individually, sold @ multiples of 5

GASKET

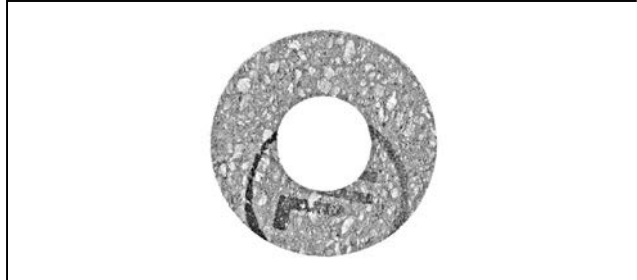

27- 25849

Priced individually, sold @ multiples of 5

GASKET

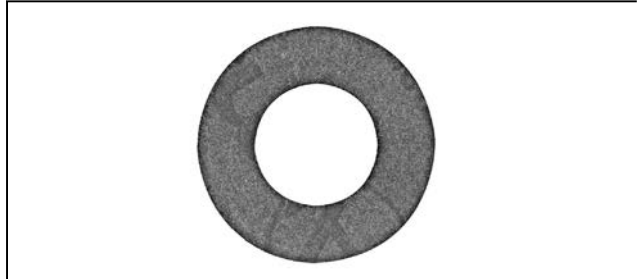

27- 25851

Priced individually, sold @ multiples of 5

GASKET



27- 29586

Priced individually, sold @ multiples of 5

GASKET

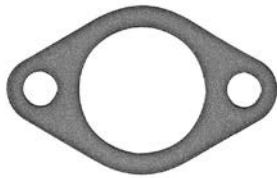

27- 31402

Priced individually, sold @ multiples of 5

GASKET

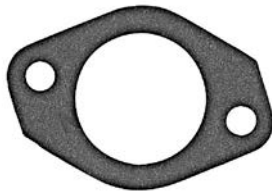

27- 48164 1

Priced individually, sold @ multiples of 5

GASKET



27- 63309

Priced individually, sold @ multiples of 3

GASKET



27- 67751 1

Priced individually, sold @ multiples of 5

GASKET



27- 73377 1

GASKET



27- 75791 1

GASKET



27- 76952

Priced individually, sold @ multiples of 2

GASKET



27- 89221 1

GASKET



27- 90430 1

GASKET



27- 828319

FUEL SYSTEM

MERCURY® OUTBOARDS

GASKET



27-828925

GASKET

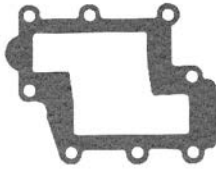

27-F433168

GASKET

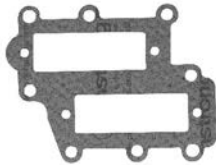

27-F433406

GASKET



27-F440906

GASKET



27-F481836

GASKET SET



27-8M0114820

Fits the 4/5/6 hp. FourStroke outboards s/n 0R057259 & prior.

GASKET SET



1399- 1717

DIAPHRAGM & GASKET KIT



1395- 9761 1

See application chart

GASKET SET

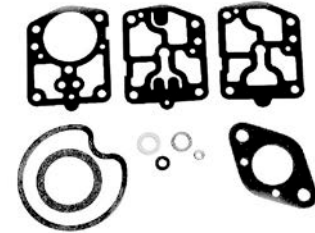

1399- 5135

DIAPHRAGM & GASKET KIT



1395- 9027

DIAPHRAGM & GASKET KIT

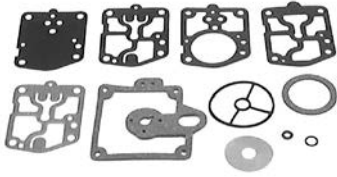

1399- 8154

GASKET SET



1395-879194024

CARBURETOR GASKET SET



1399- 2015

GASKET SET



1399- 5198

GASKET SET



1395-811223 1

Carburetor gasket set with numerous 2-cycle outboard applications. Review the Electronic Parts Catalog for your specific application.

DIAPHRAGM & GASKET KIT



1395- 9024

GASKET SET



1395- 9651

GASKET SET



1395- 6200

GASKET SET



810749 2

FUEL SYSTEM

MERCURY® OUTBOARDS

GASKET SET

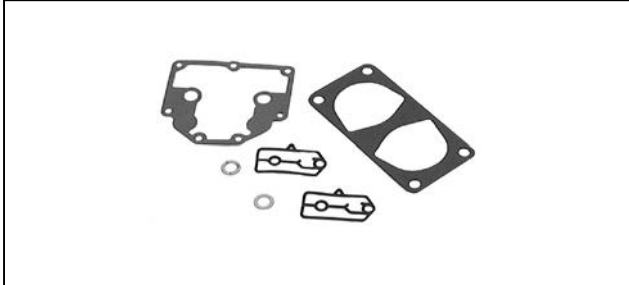

810749 3

CARBURETOR REPAIR KIT



1395- 7826

GASKET SET



1395- 6452

CARBURETOR REPAIR KIT

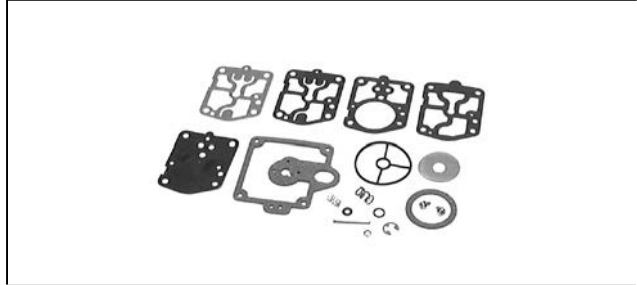

1399- 8153

CARBURETOR REPAIR KITS - MERCURY/MARINER

CARBURETOR REPAIR KIT



1395- 5109 1

CARBURETOR REPAIR KIT



1395- 8506

CARBURETOR REPAIR KIT

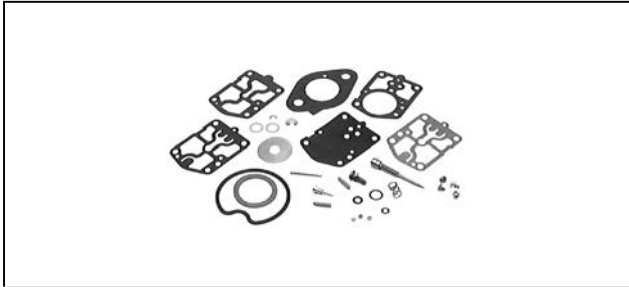

1399- 5199 1

CARBURETOR REPAIR KIT



1395- 9023

CARBURETOR REPAIR KIT

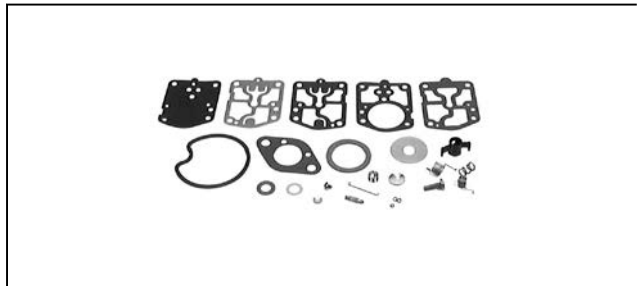

1395- 9026

CARBURETOR REPAIR KIT



1395- 9262 1

CARBURETOR REPAIR KIT



804346T02

CARBURETOR REPAIR KIT



1395- 9648 1

CARBURETOR REPAIR KIT



809594A 1

CARBURETOR REPAIR KIT



1395- 9650

CARBURETOR REPAIR KIT

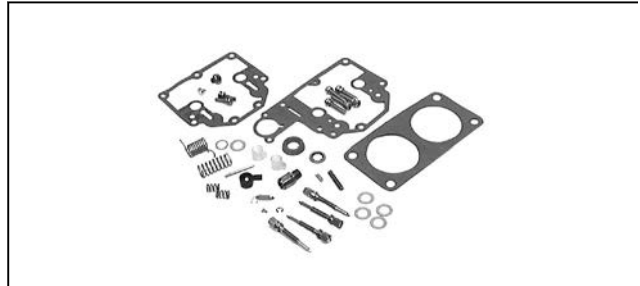

1395-811691 2

CARBURETOR REPAIR KIT

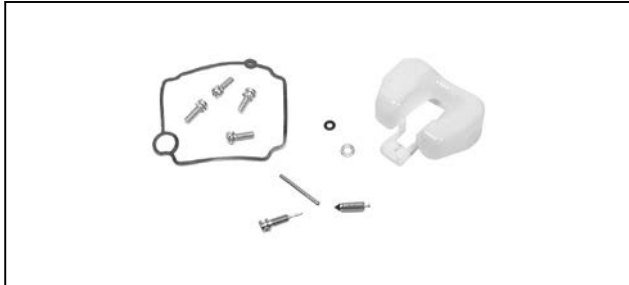

802706A 1

CARBURETOR REPAIR KIT



1395-811691 3

CARBURETOR REPAIR KIT



809449A 1

CARBURETOR REPAIR KIT



812953

Not all parts listed are available for the European, C.I.S., Africa and Middle East Markets.
 For more information, please contact your local Mercury, Mariner, MerCruiser or Quicksilver Office.

FUEL SYSTEM

MERCURY® OUTBOARDS

CARBURETOR REPAIR KIT



1395-823635 4

CARBURETOR REPAIR KIT



855546A 3

CARBURETOR REPAIR KIT



1395-823707 2

CARBURETOR REPAIR KIT



855546A 4

CARBURETOR REPAIR KIT



854256

CARBURETOR REPAIR KIT



8M0090764

CARBURETOR REPAIR KIT



854256 1

CARBURETOR REPAIR KIT



1399-879194026

CARBURETOR REPAIR KIT



855546A 1

CARBURETOR REPAIR KIT



8M0044575

Includes new float, float pin, inlet needle, bowl gasket and flange gaskets.
Fits the carburetor on the F4/5/6 hp. FourStroke outboards, serial number OR000001 and above.

CARBURETOR REPAIR KIT



8M0044576

Includes new float, float pin, inlet needle, bowl gasket, air box o-ring and flange gaskets.
Fits the carburetor on the F8/9.9 hp. FourStroke outboards, serial number OR042475 and above.

CARBURETOR REPAIR KIT

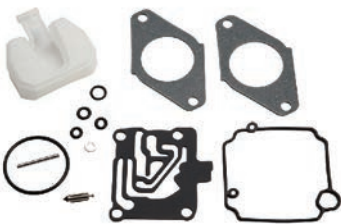

8M0044577

Includes new float, float pin, inlet needle, bowl gasket, air box o-ring and flange gaskets.
Fits the carburetor on the F15/20 hp. FourStroke outboards, serial number OR235168 and above.

CARBURETOR REPAIR KITS - EARLY MARINER

CARBURETOR REPAIR KIT

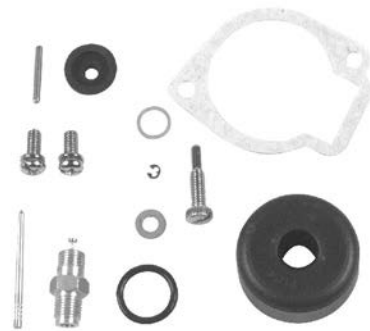

41859M

CARBURETOR REPAIR KIT



91755T

CARBURETOR REPAIR KIT



11502M

CARBURETOR REPAIR KIT



84473T

FUEL SYSTEM

MERCURY® OUTBOARDS

CARBURETOR REPAIR KIT



814481M

CARBURETOR REPAIR KIT



811038M

CARBURETOR REPAIR KIT



97667T

CARBURETOR REPAIR KIT



17068M

CARBURETOR DIAPHRAGM KITS

DIAPHRAGM & GASKET KIT



1395- 9761 1

See application chart

DIAPHRAGM KIT



1399- 5137

DIAPHRAGM & GASKET KIT

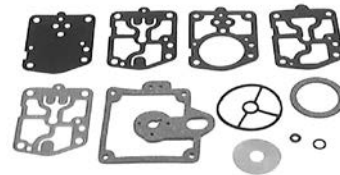

1399- 8154

DIAPHRAGM & GASKET KIT



1395- 9024

FUEL PUMP DIAPHRAGM

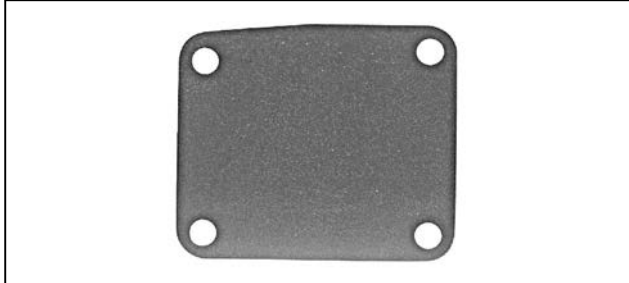

11497M

FUEL PUMP DIAPHRAGM

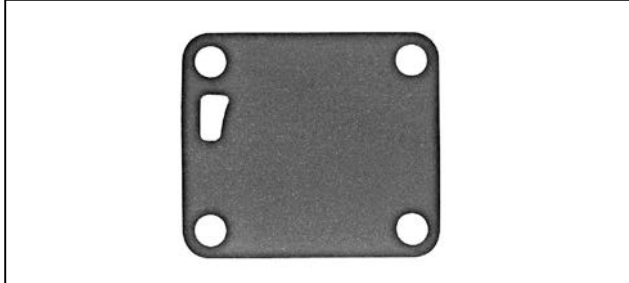

84262M

FUEL PUMP DIAPHRAGM

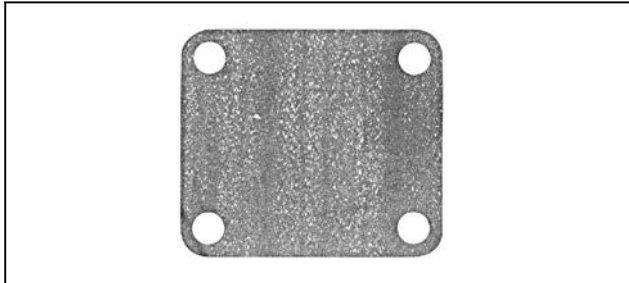

84265M

INLET NEEDLE ASSEMBLIES

INLET NEEDLE & SEAT ASSEMBLY



1395- 7624

INLET NEEDLE & SEAT ASSEMBLY



1395- 7824

INLET NEEDLE & SEAT ASSEMBLY



1395- 8318 1

INLET NEEDLE & SEAT ASSEMBLY



1395- 9258 1

INLET NEEDLE & SEAT ASSEMBLY



17050M

INLET NEEDLE & SEAT ASSEMBLY



19271 1

INLET NEEDLE & SEAT ASSEMBLY



95263A 1

INLET NEEDLE ASSEMBLY



16254

INLET NEEDLE & SEAT ASSEMBLY



1395-811690 1

INLET NEEDLE ASSEMBLY



16254 3

INLET NEEDLE ASSEMBLY



1395- 9022

INLET NEEDLE ASSEMBLY



1395 803861

INLET NEEDLE ASSEMBLY



1395-879194011

INLET NEEDLE ASSEMBLY



809570

INLET NEEDLE ASSEMBLY



14182M

INLET NEEDLE ASSEMBLY



809570 1

INLET NEEDLE ASSEMBLY**809570002**

Fits Mercury/Mariner 8/9.9 hp. FourStroke outboards, beginning with Model Year 2005.

INLET NEEDLE ASSEMBLY**854247****INLET NEEDLE ASSEMBLY****F10265****FLOATS****FLOAT ASSEMBLY****1395- 8673****FLOAT ASSEMBLY****1395- 9169 1****FLOAT ASSEMBLY****1395- 9293****FLOAT ASSEMBLY****1395- 9594****FLOAT ASSEMBLY****16253**

FLOAT ASSEMBLY



16253 2

Fits Mercury/Mariner 8/9.9 hp. FourStroke outboards, beginning with Model Year 2005.

FLOAT ASSEMBLY



16253 3

FLOAT ASSEMBLY



19273

FLOAT ASSEMBLY



95259

FLOAT ASSEMBLY



804184

FLOAT ASSEMBLY



809569

FLOAT ASSEMBLY



810738

FLOAT ASSEMBLY



1395 823620

FLOAT ASSEMBLY



854253

FLOAT ASSEMBLY



854253 1

FLOAT ASSEMBLY



898103245

FLOAT ASSEMBLY



891730A01

CARBURETOR REPAIR CHARTS

Mercury/Mariner InLine Carburetor Repair Kits

Model	Carb # or SN	Diaphragm Kit	Float	Gasket Kit	Inlet Needle Assy	Repair Kit
2.5	Serial #USA-0G710613 & Above Serial #BEL-0P017000 & Above	N/A	95259	N.L.A.	95263 1	855546A 4
2.5 FourStroke	Serial #JPN-0R131842-0R131841	N/A	898101288	N/A	16254 3	898103A68
2.5 FourStroke	Serial #JPN-0R131842 & Above	N/A	898103245	N/A	16254 3	8M0090764
3.3	Serial #USA-0G710613 & Above Serial #BEL-0P017000 & Above	N/A	95259	N.L.A.	95263 1	855546A 4
3.5 FourStroke	Serial #JPN-0R131842-0R131841	N/A	898101288	N/A	16254 3	898103A68
3.5 FourStroke	Serial #JPN-0R131842 & Above	N/A	898101288	N/A	16254 3	8M0090764
3.9 (39)	KB-7A,KB-7B	N/A	1395- 8673	1399- 1717	1395- 9258 1	1395- 9262 1(1)(2)
4 (40)(1 cyl)	KB-10A	N/A	1395- 8673	1399- 1717	1395- 9258 1	1395- 9262 1(1)(2)
4 (1 cyl)	WMD-1	N/A	1395- 8673	1399- 1717	1395- 8318 1	N.L.A.
4 (1 cyl)	Serial USA-0A855097 & Above Serial BEL-9589154 & Above	N/A	16253	N.L.A.	16254	855546A 1
4 (2 cyl)	LMO-1	N/A	N.L.A.	N.L.A.	(4)	N.L.A.
4 (2 cyl)	LMO-2	N/A	N.L.A.	N.L.A.	N.L.A.	N.L.A.
4 (2 cyl)	LMO-3	N/A	N.L.A.	N.L.A.	(4)	N.L.A.
4 (2 cyl)	LMO-4	N/A	N.L.A.	N.L.A.	(4)	N.L.A.
4 FourStroke	Serial# JPN 0R000001 & above	N/A	16253 3	N/A	16254 3	8M0044575
4.5 (1 cyl)	KB-10A	N/A	1395- 8673	1399- 1717	1395- 9258 1	1395- 9262 1(1)(2)
4.5 (1 cyl)	WMD-1	N/A	1395- 8673	1399- 1717	1395- 8318 1	N.L.A.
5 (1 cyl)	Serial USA-0A855097 & Above Serial BEL-9589154 & Above	N/A	16253	N.L.A.	16254	855546A 1
5 FourStroke	Serial# JPN 0R000001 & Above	N/A	16253 3	N/A	16254 3	8M0044575
6	KB-6A, 6B	N/A	1395- 8673	1399- 1717	1395- 9258 1	1395- 9262 1
6	AJ-57A	N/A	1395- 8673	N.L.A.	1395- 9258 1	N.L.A.

**Not all parts listed are available for the European, C.I.S., Africa and Middle East Markets.
For more information, please contact your local Mercury, Mariner, MerCruiser or Quicksilver Office.**

FUEL SYSTEM

MERCURY® OUTBOARDS

Model	Carb # or SN	Diaphragm Kit	Float	Gasket Kit	Inlet Needle Assy	Repair Kit
6	WMC-5,5A,5B,7,7A,17,17B,17C,18,18,18B,19,19A,20,20	1395- 9761 1	1395- 9169 1	1395- 9761 1	1395-803861	1395- 9648 1
6	WMC-23,28,34,39,41,41A,47,47A,49,49A,57	1395- 9761 1	1395- 9169 1	1395- 9761 1	1395-803861	1395-823707 2
6 FourStroke	Serial# JPN 0R000001 & Above	N/A	16253 3	N/A	16254 3	8M0044575
7.5 (7.5, 75)	BB-2A,2B,2C,4A,5A,5B,5C,5D,7A,7C	1399- 5137	1395- 9293	1399- 5135	1395- 9022	1399-879194026
7.5 (7.5, 75)	KB-9A, 12A	N/A	1395- 8673	1399- 1717	1395- 9258 1	1395- 9262 1
7.5	WMB-2,4	N/A	1395- 9293	1395- 9027	1395- 9022	1395- 9026
8	WMC-5,5A,5B,7,7A,17,17B,17C,18,18A,18B,19,19A,20,2	1395- 9761 1	1395- 9169 1	1395- 9761 1	1395-803861	1395- 9648 1
8	WMC-23,28,34,39,41,41A,47,47A,49,49A,57	1395- 9761 1	1395- 9169 1	1395- 9761 1	1395-803861	1395-823707 2
8 (4-Stroke)(232 cc)	Serial# USA-0H000058-0T979999	N/A	N.L.A.	N.L.A.	14182M	N.L.A.
8 (4-Stroke) (323cc)	Serial# BEL 0P086824-0P325499	N/A	809569	N.L.A.	809570 1	802706A 1
8 FourStroke	Serial# JPN 0R042475 & above Serial# BEL 0P325500 & above	N/A	16253 2	N/A	809570002	8M0044576
9.8 (9.8, 110)	BB-1A,1B,1C,3A,3B,3C,6A,6C	1399- 5137	1395- 9293	1399- 5135	1395- 9022	1399-879194026
9.8 (9.8, 110)	KB-5A,8A,11A	N/A	1395- 8673	1399- 1717	1395- 9258 1	1395- 9262 1
9.8	WMB-1, 3	N/A	1395- 9293	1395- 9027	1395- 9022	1395- 9026
9.9	WMC-5,5A,5B,7,7A,17,17B,17C,18,18A,18B,19,19A,20,2	1395- 9761 1	1395- 9169 1	1395- 9761 1	1395-803861	1395- 9648 1
9.9	WMC-23,28,34,39,41,41A,47,47A,49,49A,57	1395- 9761 1	1395- 9169 1	1395- 9761 1	1395-803861	1395-823707 2
9.9 (4-Stroke) (232cc)	Serial# USA-0H000058 & 0H017099	N/A	N.L.A.	N.L.A.	14182M	N.L.A.
9.9 (4-Stroke) (323cc)	Serial# USA-0G760300-0T979999	N/A	809569	N.L.A.	809570 1	802706A 1
9.9 (4-Stroke) (323cc)	Serial# BEL 0P075166-0P325499	N/A	809569	N.L.A.	809570 1	802706A 1
9.9 FourStroke	Serial# JPN 0R042475 & above Serial# BEL 0P325500 & above	N/A	16253 2	N/A	809570002	8M0044576
10 (100)	AJ-56AB	N/A	1395- 8673	N.L.A.	1395- 9258 1	N.L.A.
10 (100)	KB-1A, 4A	N/A	1395- 8673	1399- 1717	1395- 9258 1	N.L.A.
10 (Sea Pro, Marathon)	WMC-33,33A,40,42,50,50A,50B,55,55A	1395- 9761 1	1395- 9169 1	1395- 9761 1	1395-803861	1395-823707 2
10 (XR10, Magnum10)	WMC-23,48,48A,49,49A	1395- 9761 1	1395- 9169 1	1395- 9761 1	1395-803861	1395-823707 2
15 (150)	KB-1A, 4A	N/A	1395- 8673	1399- 1717	1395- 9258 1	N.L.A.
15	WMC-5,5A,5B,7,7A,17,17B,17C,18,18A,18B,19,19A,20,2	1395- 9761 1	1395- 9169 1	1395- 9761 1	1395-803861	1395- 9648 1
15	WMC-23,28,34,39,41,41A,47,47A,49,49A,57	1395- 9761 1	1395- 9169 1	1395- 9761 1	1395-803861	1395-823707 2
15 (Super 15,15XD)	WMC-13,13A,14,14A,15A,16A,24,25,26,27,29,30,31,31A	1395- 9761 1	1395- 9169 1	1395- 9761 1	1395-803861	1395-823707 2
15 (Sea Pro, Marathon)	WMC-33,33A,40,42,50,50A,50B,55,55A	1395- 9761 1	1395- 9169 1	1395- 9761 1	1395-803861	1395-823707 2
15 FourStroke, 323cc	Serial# USA-0G590000-1B727495 Serial# BEL 0P075166 & Above	N/A	809569	N.L.A.	809570 1	802706A 1
15 FourStroke, 351cc	Serial# JPN 0R235949 & Above	N/A	16253 2	N/A	809570002	8M0044577
18	BC-1A,1B,1C,2A,2B,2D	1399- 8154	N.L.A.	1399- 8154	N.L.A.	1399- 8153
18	WMC-1,2,3,4,9,10,11,12	1395- 9761 1	1395- 9169 1	1395- 9761 1	1395-803861	1395- 9648 1
18	WMC-13,13A,14,14A,15A,16A,24,25,26,27,29,30,31,31A	1395- 9761 1	1395- 9169 1	1395- 9761 1	1395-803861	1395-823707 2
20 (200)	KA-22A,22B,22C,23A,25A	N/A	1395- 8673	1399- 2015	1395- 9258 1	1395- 9262 1
20 (20,200)	BA-1A,2A,2C,2D,2E	1399- 5137	1395- 9293	1399- 5198	(4)	1399- 5199 1
20 (20,200)	BC-1A,1B,1C,2A,2B,2D	1399- 8154	N.L.A.	1399- 8154	N.L.A.	1399- 8153
20	WMC-1,2,3,4,9,10,11,12	1395- 9761 1	1395- 9169 1	1395- 9761 1	1395-803861	1395- 9648 1
20	WMC-13,13A,14,14A,15A,16A,24,25,26,27,29,30,31,31A	1395- 9761 1	1395- 9169 1	1395- 9761 1	1395-803861	1395-823707 2
20 JET	WMC-45, 53A	1395- 9761 1	1395- 9169 1	1395- 9761 1	1395-803861	1395-823707 2
20 FourStroke	Serial# JPN-0R235168 & Above	N/A	16253 2	N/A	809570002	8M0044577
25 (2cyl)	BC-1A,1B,1C,2A,2B,2D	1399- 8154	N.L.A.	1399- 8154	N.L.A.	1399- 8153
25 (2cyl)	WMC-1,2,3,4,9,10,11,12	1395- 9761 1	1395- 9169 1	1395- 9761 1	1395-803861	1395- 9648 1

FUEL SYSTEM

MERCURY® OUTBOARDS

Model	Carb # or SN	Diaphragm Kit	Float	Gasket Kit	Inlet Needle Assy	Repair Kit
25 (2cyl)	WMC-13,13A,14,14A,15A,16A,24,25,26,27,29,30,31,31A	1395- 9761 1	1395- 9169 1	1395- 9761 1	1395- 803861	1395- 823707 2
25 (3 cyl)	FD-3C, 3D	N/A	891730A01		F10265	809449A 1
25 FourStroke	Serial# USA-0G590000-0T408999 Serial# BEL-9973100-0P153499	N/A	854253	N.L.A.	854247	854256
25 FourStroke	Serial# USA-0409000-1B344298 Serial# BEL 0P153500-0P388282	N/A	854253 1	N.L.A.	854247	854256 1
25 FourStroke	Bodensee, Serial# BEL 0P017000-0P388282	N/A	854253	N.L.A.	854247	854256
30 (300)(4 cyl)	AJ-54A	N/A	1395- 8673	N.L.A.	1395- 9258 1	N.L.A.
30 (300)(4 cyl)	KB-2A	N/A	1395- 8673	1399- 1717	1395- 9258 1	N.L.A.
30 (2 cyl)(644cc)	WME-36,36A,37,37A,38,39A,42,42A,63,64,65,66,67	N/A	1395- 9594	1395- 811223 1	1395- 879194011	1395- 823635 4
30 JET (4 cyl)	WMA 10, 13	N/A	1395-823620	1395- 9651	1395- 879194011	1395- 9650
30 JET (3 cyl)	WME 53,68,69	N/A	1395- 9594	1395- 811223 1	1395- 879194011	1395- 823635 4
30 FourStroke (3 cyl)	Serial# USA 0G760300-0T178499	N/A	854253	N/A	854247	854256
30 FourStroke (3 cyl)	Serial# USA 0T178500 & Above Serial# BEL 0P153500 & Above	N/A	854253 1	N/A	854247	854256 1
35 (350)(4 cyl)	AJ-54A	N/A	1395- 8673	N.L.A.	1395- 9258 1	N.L.A.
35 (350)(4 cyl)	KB-2A	N/A	1395- 8673	1399- 1717	1395- 9258 1	N.L.A.
35 (2 cyl)	KC-4A,8A,9A,9B,9C,13A	N/A	1395- 8673	1399- 2015	1395- 8318 1	1395- 9262 1
40 (400)(4 cyl)	KA-2A,9A	N/A	1395- 8673	1399- 2015	1395- 9258 1	N.L.A.
40 (40,400,402)(2 cyl)	KD-5A	N/A	1395- 8673	1395- 879194024	1395- 9258 1	1395- 9262 1
40 (40,400,402)(2 cyl)	WMK-1,8,21,24,31,33,34,38	N/A	1395- 8673	1395- 879194024	1395- 8318 1	1395- 5109 1
40 (2 cyl)(644cc)	WME-36,36A,37,37A,38,39A,42,42A,63,64,65,66,67	N/A	1395- 9594	1395- 811223 1	1395- 879194011	1395- 823635 4
40 (3 cyl)	WME-53,68,69	N/A	1395- 9594	1395- 811223 1	1395- 879194011	1395- 823635 4
40 (4 cyl)	WMA-4	1395- 9024	1395- 9293	1395- 9024	1395- 9022	1395- 9023
40 (4 cyl)	WMA-7B	N/A	1395- 9293	1395- 9651	1395- 879194011	1395- 9650
40 (4 cyl)	WMA-9,10,13	N/A	1395-823620	1395- 9651	1395- 879194011	1395- 9650
40 FourStroke (4 cyl)	Serial# USA-0G231123-0T178499	N/A	809569	N.L.A.	809570 1	809594A 1
40 FourStroke (4 cyl)	Serial# USA 0T228405-0T598999 Serial# BEL 0P094500-0P206999	N/A	854253 1	N/A	854247	854256 1
40 (4-Stroke)(3 cyl)	Serial# USA 0G760300-0T178499	N/A	854253	N/A	854247	854256
40 (4-Stroke)(3 cyl)	Serial# USA 0T178500 & Above Serial# BEL 0P153500 & Above	N/A	854253 1	N/A	854247	854256 1
45 (450)(4 cyl)	KA-17A	N/A	1395- 8673	1399- 2015	1395- 9258 1	1395- 9262 1
45 (4 cyl)	WMA-4	1395- 9024	1395- 9293	1395- 9024	1395- 9022	1395- 9023
45 (4 cyl)	WMA-7B	N/A	1395- 9293	1395- 9651	1395- 879194011	1395- 9650
45 (4 cyl)	WMA-9,10,13	N/A	1395-823620	1395- 9651	1395- 879194011	1395- 9650
45 (4-Stroke, Bodensee)	Serial# USA-0G231123 & Above	N/A	809569	N.L.A.	809570 1	809594A 1
45 JET (3 cyl)	WME-57,58	N/A	1395- 9594	1395- 811223 1	1395- 879194011	1395- 823635 4
50 (4 cyl)	KA-13A,18A,19A,21A,21B,21C,21D,24A,26A,26B,27A	N/A	1395- 8673	1399- 2015	1395- 9258 1	1395- 9262 1
50 (4 cyl)	BA-3A,3B,3C,3D,4A	1399- 5137	1395- 9293	1399- 5198	1395- 9022	1399- 5199 1
50 (4 cyl)	WMA-1,3	1395- 9024	1395- 9293	1395- 9024	1395- 9022	1395- 9023
50 (4 cyl)	WMK-8	N/A	1395- 8673	1395- 879194024	1395- 8318 1	1395- 5109 1
50 (3 cyl)	WM-13,13A,15,15A,16,16A,18	N/A	19273	1395- 6200	19271 1	812953
50 (3 cyl)	WME-22,22B,23,24,26,27,28,35,43,44,45,53,68,69	N/A	1395- 9594	1395- 811223 1	1395- 879194011	1395- 823635 4
50 (4-Stroke)(935 cc)	Serial# USA 0T178500-0T598999	N/A	809569	N.L.A.	809570 1	809594A 1

Not all parts listed are available for the European, C.I.S., Africa and Middle East Markets.
For more information, please contact your local Mercury, Mariner, MerCruiser or Quicksilver Office.

FUEL SYSTEM

MERCURY® OUTBOARDS

Model	Carb # or SN	Diaphragm Kit	Float	Gasket Kit	Inlet Needle Assy	Repair Kit
50 (4-Stroke)(995 cc)	Serial# USA 0T178500-0T598999 Serial# BEL 0P094500-0P206999	N/A	854253 1	N/A	854247	854256 1
55	WM-13,13A,15,15A,16,16A,18	N/A	19273	1395- 6200	19271 1	812953
55	WME-22,22B,23,24,26,27,28,35,43,44,45,57,58	N/A	1395- 9594	1395-811223 1	1395-879194011	1395-823635 4
60 (600)(6 cyl)	KB-3A	N/A	1395- 8673	1399- 1717	1395- 9258 1	N.L.A.
60 (3 cyl)	WM-13,13A,15,15A,16,16A,18	N/A	19273	1395- 6200	19271 1	812953
60 (3 cyl)	WME-22,22B,23,24,26,27,28,35,43,44,45,57,58	N/A	1395- 9594	1395-811223 1	1395-879194011	1395-823635 4
60 FourStroke (995 cc)	Serial# USA 0T178500-0T598999 Serial# BEL 0P094500-0P206999	N/A	854253 1	N/A	854247	854256 1
65 (650)(4 cyl)	KC-2A,5A,5B,5C,11A,15A	N/A	1395- 8673	1399- 2015	1395- 9258 1	1395- 9262 1
65 (650)(3 cyl)	WMK-5,12,13,20	N/A	1395- 8673	1395-879194024	1395- 8318 1	1395- 5109 1
65 (650)(3 cyl)	WM-2	N/A	1395- 8673	1395- 6200	1395- 8318 1	N.L.A.
65 (650)(3 cyl)	WM-4	N/A	1395- 8673	1395- 6200	1395- 8318 1	812953
65 JET (3 cyl)	WME-29,30,31,41,46,47,48,49,59,60,61,62,75,76,77,7	N/A	1395- 9594	1395-811223 1	1395-879194011	1395-823635 4
70 (700)(6 cyl)	KA-8A,12A	N/A	1395- 8673	1399- 2015	1395- 9258 1	1395- 9262 1
70 (3 cyl)	WM-6,8,9,11	N/A	19273	1395- 6200	1395- 8318 1	812953
70 (3 cyl)	WME-1,1A,1B,4,5,6,6A,7,7B,8,9,10,10A,15,15A,17,18,	N/A	1395- 9594	1395-811223 1	1395-879194011	1395-823635 4
75 (4 cyl)	WM-14,17	N/A	19273	1395- 6200	19271 1	812953
75 (3 cyl)	WME-1,1A,1B,4,5,6,6A,7,7B,8,9,10,10A,15,15A,17,18,	N/A	1395- 9594	1395-811223 1	1395-879194011	1395-823635 4
75 FourStroke	Serial# USA 0G960500-1B226999 Serial# BEL 0P094500 & Above	N/A	804184	N/A	17050M	804346T02
80 (800)(6 cyl)	KA-10A,11A,14A,16A,KC-3A	N/A	1395- 8673	1399- 2015	1395- 9258 1	N.L.A.
80 (80,800)(4 cyl)	KD-4A	N/A	1395- 8673	1395-879194024	1395- 8318 1	1395- 9262 1
80 (80,800)(4 cyl)	WM-5,10,12,14,17	N/A	19273	1395- 6200	1395- 8318 1	812953
80 (3 cyl)	WME-1,1A,1B,4,5,6,6A,7,7B,8,9,10,10A,15,15A,17,18,	N/A	1395- 9594	1395-811223 1	1395-879194011	1395-823635 4
80 JET (4 cyl)	WME-32,32A,50,79	N/A	1395- 9594	1395-811223 1	1395-879194011	1395-823635 4
85 (850)(6cyl)	KA-10A,11A,14A,16A,KC-3A	N/A	1395- 8673	1399- 2015	1395- 9258 1	N.L.A.
85 (850)(4 cyl)	WM-3,5	N/A	19273	1395- 6200	1395- 8318 1	812953
85 (850)(4 cyl)	WMK-4,16,17	N/A	1395- 8673	1395-879194024	1395- 8318 1	1395- 5109 1
90 (900)(6 cyl)	KC-6A	N/A	1395- 8673	1399- 2015	1395- 9258 1	1395- 9262 1
90 (90,900)(6 cyl)	WMK-23,27,30,35,39	N/A	1395- 8673	1395-879194024	1395- 8318 1	1395- 5109 1
90 (3 cyl)	WME-1,1A,1B,4,5,6,6A,7,7B,8,9,10,10A,15,15A,17,18,	N/A	1395- 9594	1395-811223 1	1395-879194011	1395-823635 4
90 FourStroke	Serial# USA 0G960500 & Above Serial# BEL 0P094500 & Above	N/A	804184	N/A	17050M	804346T02
95 (950)(6 cyl)	KC-6A	N/A	1395- 8673	1399- 2015	1395- 9258 1	1395- 9262 1
100 (1000) (6 cyl)	KC-1A,7A,7B,10A,14A	N/A	1395- 8673	1399- 2015	1395- 9258 1	1395- 9262 1
100 (1000) (6 cyl)	KD-1A,1B,2A,3A	N/A	1395- 8673	1395-879194024	1395- 8318 1	1395- 9262 1
100 (4 cyl)	WME-11,14,20,20A,21,21A,32,32A,50,79	N/A	1395- 9594	1395-811223 1	1395-879194011	1395-823635 4
110 (1100)(6 cyl)	KC-1A,7A,7B,10A,14A	N/A	1395- 8673	1399- 2015	1395- 9258 1	1395- 9262 1
115 (115,1150)(6 cyl)	KD-6A,6B	N/A	1395- 8673	1395-879194024	1395- 8318 1	1395- 9262 1
115 (115,1150)(6 cyl)	WMK-3,10,15,18,26,28,32,36,40,41	N/A	1395- 8673	1395-879194024	1395- 8318 1	1395- 5109 1
115 (4 cyl)	WME-11,14,20,20A,21,21A,33,40,40A	N/A	1395- 9594	1395-811223 1	1395-879194011	1395-823635 4
125 (1250)(6 cyl)	KD-1A,1B,2A,3A	N/A	1395- 8673	1395-879194024	1395- 8318 1	1395- 9262 1
125 (4 cyl)	WME-34,52,81	N/A	1395- 9594	1395-811223 1	1395-879194011	1395-823635 4
135 (1350)(6 cyl)	KD-7A,7B	N/A	1395- 8673	1395-879194024	1395- 8318 1	1395- 9262 1
135 (1350)(6 cyl)	WMK-4	N/A	1395- 8673	1395-879194024	1395- 8318 1	1395- 5109 1
140 (140,1400)(6 cyl)	WMK-7,9,25,29	N/A	1395- 8673	1395-879194024	1395- 8318 1	1395- 5109 1
150 (1500)(6 cyl)	WMK-11,14,19,22	N/A	1395- 8673	1395-879194024	1395- 8318 1	1395- 5109 1

(1) Kit does not include jet or idle needle.

(2) Kit does not include idle tube or nozzle.

(4) Included in carburetor repair parts kit.

Mercury/Mariner V-6 Carburetor Repair Kits

Model	Serial # Range	Carb #	Float	Gasket Kit	Inlet Needle Assy	Repair Kit
V-105 JET	USA 0D082000 - 0G303045	WMH-13, 13B, 23, 31	810738	810749 2	1395-811690 1	1395-811691 2
V-105 JET	USA 0G303046 and up	WMV-2, 2A	810738	810749 3	1395-811690 1	1395-811691 3
V-135	USA 0A904646 - 0C100860	WH-33, 40	N.L.A.	1395- 6452	1395- 7824	1395- 8506
V-135	USA 0A904646 - 0C100860	WH-32, 35, 38	N.L.A.	1395- 6452	1395- 7824	1395- 7826
V-135	USA 0C100861 - 0C239552	WH- 35, 38	N.L.A.	1395- 6452	1395- 7824	1395- 7826
V-135	USA 0C100861 - 0C239552	WH- 40, 48	N.L.A.	1395- 6452	1395- 7824	1395- 8506
V-135	USA 0C239553 - 0D081999	WMH- 8, 8A	810738	810749 2	1395-811690 1	1395-811691 2
V-135	USA 0D082000 - 0G303045	WMH-12A, 12B	810738	810749 2	1395-811690 1	1395-811691 2
V-135	USA 0D082000 - 0G303045	WMH-28, 30	810738	810749 2	1395-811690 1	1395-811691 2
V-135	USA 0G303046 - 0G760299	WMV-1, 1A	810738	810749 3	1395-811690 1	1395-811691 3
V-135	USA 0G760300 and up	WMV-1A, 15, 15A	810738	810749 3	1395-811690 1	1395-811691 3
V-140 JET	USA 0G082000 - 0G303045	WMH-16, 21, 34, 39	810738	810749 2	1395-811690 1	1395-811691 2
V-140 JET	USA 0G303046 - 0G760299	WMV-5, 5A	810738	810749 3	1395-811690 1	1395-811691 3
V-140 JET	USA 0G760300 and up	WMV-5A	810738	810749 3	1395-811690 1	1395-811691 3
V-150 (150,1500)	USA prior to - 0A904645	WH-9	N.L.A.	1395- 6452	1395- 7824	1395- 7826
V-150 (150,1500)	USA prior to - 0A904645	WH-12	N.L.A.	1395- 6452	1395- 7824	1395- 7826
V-150 (150,1500)	USA prior to - 0A904645	WH-29	N.L.A.	1395- 6452	1395- 7824	1395- 8506
V-150	USA 0A904646 - 0C239552	WH-35, 38	N.L.A.	1395- 6452	1395- 7824	1395- 7826
V-150	USA 0A904646 - 0C239552	WH-40, 48	N.L.A.	1395- 6452	1395- 7824	1395- 8506
V-150	USA 0C239553 - 0D081999	WMH-1, 7	810738	810749 2	1395-811690 1	1395-811691 2
V-150	USA 0D082000 - 0G303045	WMH-13, 13B, 23, 31	810738	810749 2	1395-811690 1	1395-811691 2
V-150	USA 0G303046 - 0G760299	WMV-2, 2A	810738	810749 3	1395-811690 1	1395-811691 3
V-150	USA 0G760300 and up	WMV-3A, 16, 16A	810738	810749 3	1395-811690 1	1395-811691 3
V-150 (XR4, MAG II)	USA 0B242885 - 0C100860	WH- 41A	N.L.A.	1395- 6452	1395- 7824	1395- 8506
V-150 (XR4, MAG II)	USA 0C100861 - 0C239552	WH-41	N.L.A.	1395- 6452	1395- 7824	1395- 8506
V-150 (XR4, MAG II)	USA 0C100861 - 0C239552	WH- 41A	N.L.A.	1395- 6452	1395- 7824	N.L.A.
V-150 (XR4, MAG II)	USA 0C239553 - 0D081999	WMH-6	810738	810749 2	1395-811690 1	1395-811691 2
V-150 (XR6, MAG III)	USA 0D082000 - 0G303045	WMH-14A, 25, 32A	810738	810749 2	1395-811690 1	1395-811691 2
V-150 (XR6, MAG III)	USA 0G303046 - 0G760299	WMV-3, 3A	810738	810749 3	1395-811690 1	1395-811691 3
V-150 (XR6, MAG III)	USA 0G762000 and up	WMV-3A, 16, 16A	810738	810749 3	1395-811690 1	1395-811691 3
V-175 (175, 1750)	USA 4301235 - 0C100860	WH-13	N.L.A.	1395- 6452	1395- 7824	1395- 7826
V-175 (175, 1750)	AUS 8058870 - 8064249	WH-13	N.L.A.	1395- 6452	1395- 7824	1395- 7826
V-175 (175, 1750)	USA 4301235 - 0C100860	WH-1, 4, 7, 28, 39, 46	N.L.A.	1395- 6452	1395- 7824	1395- 7826
V-175 (175, 1750)	AUS 8058870 - 8064249	WH-1, 4, 7, 28, 39, 46	N.L.A.	1395- 6452	1395- 7824	1395- 7826
V-175 (175, 1750)	USA 4301235 - 0C100860	WH-7A	N.L.A.	1395- 6452	1395- 7824	1395- 7826
V-175 (175, 1750)	AUS 8058870 - 8064249	WH-7A	N.L.A.	1395- 6452	1395- 7824	1395- 7826
V-175 (175, 1750)	USA 4301235 - 0C100860	WH-17	N.L.A.	1395- 6452	1395- 7824	1395- 7826
V-175 (175, 1750)	AUS 8058870 - 8064249	WH-17	N.L.A.	1395- 6452	1395- 7824	1395- 7826
V-175 (175, 1750)	USA 4301235 - 0C100860	WH-17R, 30, 34	N.L.A.	1395- 6452	1395- 7824	1395- 8506
V-175 (175, 1750)	AUS 8058870 - 8064249	WH-17R, 30, 34	N.L.A.	1395- 6452	1395- 7824	1395- 8506
V-175	USA 0C00861 - 0C239552	WH-34	N.L.A.	1395- 6452	1395- 7824	1395- 8506
V-175	USA 0C239553 - 0D081999	WMH-2, 11	810738	810749 2	1395-811690 1	1395-811691 2
V-175	USA 0D082000 - 0G303045	WMH-15, 22, 33	810738	810749 2	1395-811690 1	1395-811691 2
V-175	USA 0G303046 - 0G760299	WMV-4, 4A	810738	810749 3	1395-811690 1	1395-811691 3
V-175	USA 0G760300 and up	WMV-4A	810738	810749 3	1395-811690 1	1395-811691 3
V-200 (V-200,V-2000)	USA 4839034 - 0C100860	WH-3	N.L.A.	1395- 6452	1395- 7824	1395- 7826
V-200 (V-200,V-2000)	AUS 8061595 - 865672	WH-3	N.L.A.	1395- 6452	1395- 7824	1395- 7826
V-200 (V-200,V-2000)	USA 4839034 - 0C100860	WH-3A, 11	N.L.A.	1395- 6452	1395- 7824	1395- 7826
V-200 (V-200,V-2000)	AUS 8058870 - 8065672	WH-3A, 11	N.L.A.	1395- 6452	1395- 7824	1395- 7826
V-200 (V-200,V-2000)	USA 4839034 - 0C100860	WH-14, 16, 18, 20, 28, 39, 46	N.L.A.	1395- 6452	1395- 7824	1395- 7826
V-200 (V-200,V-2000)	AUS 8058870 - 8065672	WH-14, 16, 18, 20, 28, 39, 46	N.L.A.	1395- 6452	1395- 7824	1395- 7826
V-200	USA 0C100861 - 0C291519	WH-46	N.L.A.	1395- 6452	1395- 7824	1395- 7826
V-200	USA 0C291520 - 0D081999	WMH-3	810738	810749 2	1395-811690 1	1395-811691 2

**Not all parts listed are available for the European, C.I.S., Africa and Middle East Markets.
For more information, please contact your local Mercury, Mariner, MerCruiser or Quicksilver Office.**

FUEL SYSTEM

MERCURY® OUTBOARDS

Model	Serial # Range	Carb #	Float	Gasket Kit	Inlet Needle Assy	Repair Kit
V-200	USA 0D082000 - 0G303045	WMH-16, 21, 34, 39	810738	810749 2	1395-811690 1	1395-811691 2
V-200	USA 0G303046 - 0G760299	WMV-5, 5A	810738	810749 3	1395-811690 1	1395-811691 3
V-200	USA 0G760300 and up	WMV-5A	810738	810749 3	1395-811690 1	1395-811691 3
V-225 (2.4L)	USA 5628028 and up	WH-5, 20	N.L.A.	1395- 6452	1395- 7824	1395- 7826
V-225 (3.0L)	USA 0D280813 - 0G303045	WMH-19, 46, 47	810738	810749 2	1395-811690 1	1395-811691 2
V-225 (3.0L)	USA 0G303046 - 0G760299	WMV-7, 13	810738	810749 3	1395-811690 1	1395-811691 3
V-225 (3.0L)	USA 0G303046 and up	WMV-13, 13A	810738	810749 3	1395-811690 1	1395-811691 3
V-225 (3.0L) SeaPro/ Marathon	USA 0G245605 - 0G303045	WMH-45	810738	810749 2	1395-811690 1	1395-811691 2
V-225 (3.0L) SeaPro/ Marathon	USA 0G303046 - 0G760299	WMH-6, 11A	810738	810749 3	1395-811690 1	1395-811691 3
V-225 (3.0L) SeaPro/ Marathon	USA All and up	WMV-11, 11A, 13, 13A, 19	810738	810749 3	1395-811690 1	1395-811691 3
V-250/V-275 (3.4L)	USA 0C101891 and up	WD-8A, 9, 9A	N.L.A.	N.L.A.	1395- 8318 1	N.L.A.
V-300 (3.4L)	USA 5611648 and up	WD-3, 5	N.L.A.	N.L.A.	1395- 8318 1	N.L.A.

Early Mariner Carburetor Repair Kits

Model	SN Code	Serial # Range	Carburetor Repair Kit
2B	6A1	000101 - 037283	N.L.A.
2B	6A1	037284 - 131231	41859M
2B	6A1	131232 and up	N.L.A.
3.5 (M)	642	23741 and up	N.L.A.
3.5 (ML)	642	41691 and up	N.L.A.
5A (M)	661	30091 and up	N.L.A.
5A (ML)	661	46596 and up	N.L.A.
5C (M)	6E3	102151 - 144066	91755T
5C (ML)	6E3		91755T
5C (M)	6E3	144067 and up	N.L.A.
5C (ML)	6E3	425197 and up	N.L.A.
6C/D	6H8		11502M
6C/D	6H6		11502M
8B (M)	677	012921 and up	84473T
8B (ML)	677	316416 and up	84473T
8C	6G1		11502M
9.9C (M)	682		84473T
9.9C (ML)	682		84473T
9.9C (E)	682		84473T
9.9C (EL)	682		84473T
9.9C (M)	682	070796 and up	814481M
9.9C (ML)	682	368040 and up	814481M
9.9C (E)	682	251511 and up	814481M
9.9C (EL)	682	554146 and up	814481M
15C (M)	684		84473T
15C (ML)	684	332301 - 332301	84473T
15C (E)	684		84473T
15C (EL)	684		84473T
15C (M)	684	052848 and up	814481M
15C (ML)	684	332302 and up	814481M
15C (E)	684	252381 and up	814481M
15C (EL)	684	553251 and up	814481M
20A (M)	653	07616 and up	N.L.A.
20A (ML)	653	37211 and up	N.L.A.
20C	6A9		84473T
25A (M)	648	24991 and up	N.L.A.
25A (ML)	648	64046 and up	N.L.A.

Model	SN Code	Serial # Range	Carburetor Repair Kit
25A (E)	648	27056 and up	N.L.A.
25A (EL)	648	56526 and up	N.L.A.
25C	695		811038M
28 (M)	664	05306 and up	N.L.A.
28 (ML)	664	41686 and up	N.L.A.
28 (E)	664	26236 and up	N.L.A.
28 (EL)	664	57421 and up	N.L.A.
30A (M)	689	230100 and up	811038M
30A (ML)	689	530100 and up	811038M
30A (E)	689	250100 and up	811038M
30A (EL)	689	550100 and up	811038M
40A (M) (Above Prop Exhaust)	676		N.L.A.
40A (ML) (Above Prop Exhaust)	676		N.L.A.
40A (E) (Above Prop Exhaust)	676		N.L.A.
40A (EL) (Above Prop Exhaust)	676		N.L.A.
40A (M) (Above Prop Exhaust)	676	A007736 and up	NLA
40A (ML) (Above Prop Exhaust)	676	A311371 and up	NLA
40A (E) (Above Prop Exhaust)	676	A100416 and up	NLA
40A (EL) (Above Prop Exhaust)	676	A403471 and up	NLA
40B (M) (Thru Prop Exhaust)	676		N.L.A.
40B (ML) (Thru Prop Exhaust)	676		N.L.A.
40B (E) (Thru Prop Exhaust)	676		N.L.A.
40B (EL) (Thru Prop Exhaust)	676		N.L.A.
40B (M) (Thru Prop Exhaust)	676	B002781 and up	NLA
40B (ML) (Thru Prop Exhaust)	676	B302426 and up	NLA
40B (E) (Thru Prop Exhaust)	676	B102786 and up	NLA
40B (EL) (Thru Prop Exhaust)	676	B405251 and up	NLA
40/40C (M)	6E9		97667T

Model	SN Code	Serial # Range	Carburetor Repair Kit
40/40C (ML)	6E9		97667T
40/40C (E)	6E9		97667T
40/40C (EL)	6E9		97667T
40/40C (M)	6E9	007666 and up	17068M
40/40C (ML)	6E9	309344 and up	17068M
40/40C (E)	6E9	105014 and up	17068M
40/40C (EL)	6E9	423163 and up	17068M
48 (M)	670	02641 and up	N.L.A.
48 (ML)	670	34581 and up	N.L.A.
W48 (M)	670		N.L.A.
W48 (ML)	670		N.L.A.
W48 (M)	670	007191 and up	N.L.A.
W48 (ML)	670	334241 and up	N.L.A.
55 (E)	663		N.L.A.
55 (EL)	663		N.L.A.
55 (E)	663	004424 and up	N.L.A.
55 (EL)	663	318399 and up	N.L.A.
W55	663		N.L.A.
60	675		N.L.A.
60	6F0		N.L.A.

COOLING SYSTEM

COOLING SYSTEM

OUTBOARD WATER PUMP KITS - COMPLETE

COMPLETE WATER PUMP



46-42089A 5

Includes both upper & lower housings, gaskets, plate and impeller. Fits 6-15 hp. outboards. See chart for specific engine applications.

COMPLETE WATER PUMP



46-8M0113799

Includes both upper & lower housings, gaskets, plate and impeller. Fits various outboard models, 40-125 hp. See chart for specific engine applications.

COMPLETE WATER PUMP



46-8M0113801

Includes both upper & lower housings, gaskets, plate and impeller. Fits various outboard models, 30-60 hp. See chart for specific engine applications.

WATER PUMP BASE ASSEMBLY



46-46893A 6

Includes both upper & lower housings, gaskets, plate and impeller. Fits various outboards 3.9-9.8(model 110). See chart for specific engine applications.

COMPLETE WATER PUMP



46-48744A 3

Includes both upper & lower housings, gaskets, plate and impeller. Fits a 20 hp (model 200) outboard, 1970-1985. See chart for serial number groupings.

COMPLETE WATER PUMP



46-70941A 3

Includes both upper & lower housings, gaskets, plate and impeller. Fits the model 45/4.5 hp. and 4 hp., 1 cylinder outboards with a .456" I.D. water impeller.

COMPLETE WATER PUMP



46-73640A 2

Includes both upper & lower housings, gaskets, plate and impeller. Fits a 70 hp. (3 cylinder) outboard. See chart for specific serial number groupings.

COMPLETE WATER PUMP



46- 77177A 3

Includes both upper & lower housings, gaskets, plate and impeller.
 Fits 30 JET (USA 0C159200-0G589999)
 35 hp. 2-cycle (2 cylinder)
 40 hp. 2-cycle (USA 4860103 thru MY1983, AUS 8052125 & above, BEL 9184451 thru MY1983, CAN 7112423 & above)
 45 hp. 2-cycle (4 cylinder)
 50 hp. 2-cycle (4 cylinder) (USA 5531630 & above, AUS 8063985 & above, BEL 9248006 & above, CAN 7143688 & above)
 50/60 2-cycle (3 cylinder) (USA 6428681-0D000749, BEL 9385911-9683054, CAN 7208333 & above)
 70 hp. 2-cycle (3 cylinder) (USA 4977157-6428680, AUS 8050200 & above, BEL 9196961-9385910, CAN 7110998-7208332).

COMPLETE WATER PUMP



46- 77516A 3

Includes both upper & lower housings, gaskets, plate and impeller.
 Fits various Mercury 35/40/50/65 hp outboard engines prior to 1976. See application chart for specific serial number breakdowns.

COMPLETE WATER PUMP



46- 803750A03

Fits Mercury/Mariner 8/9.9 hp. FourStroke outboards (non-BigFoot), beginning with Model Year 2005.

COMPLETE WATER PUMP



46-812966A12

Includes both upper and lower housings, gaskets, key, O-ring, plate, and impeller
 Fits various outboard models, 30-60 hp EFI and Carbureted FourStrokes. See chart for specific engine applications.

COMPLETE WATER PUMP



817275A 5

Includes both upper & lower housings, gaskets, plate and impeller.
 Fits 3.0L DFI outboards. See chart for specific engine applications.

COMPLETE WATER PUMP



817275A 6

Includes both upper & lower housings, gaskets, plate and impeller.
 Fits 3.0L DFI outboards. See chart for specific engine applications.

COOLING SYSTEM

COMPLETE WATER PUMP



817275A09

Includes both upper and lower housings, gaskets, seals, key, Oil-carrier, retaining ring, plate, and impeller.

135-300 hp FourStroke Verado (4 and 6 cylinder)

3.0L DFI and EFI outboards. See chart for specific engine applications.

COMPLETE WATER PUMP

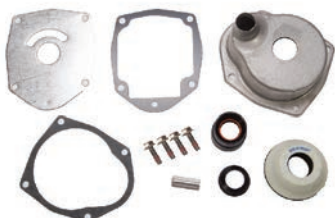

8M0078858

Includes water impeller, upper and lower housings, face plate, gaskets, drive key, face seal and water tube coupling.

COMPLETE WATER PUMP



8M0094529

Includes upper and lower housings, gaskets, plate, seals, key and impeller.

Fits 150 EFI FourStroke 1B905505 and Up, 75-115 EFI FourStroke 2B094996 and Up

COMPLETE WATER PUMP KIT



98-8M0135821

Includes both upper & lower housings, gaskets, plate and impeller.

15/20 EFI FourStroke outboard, 0R833820 and above.

Quicksilver Branded

OUTBOARD WATER PUMP UPPER REPAIR KITS

WATER PUMP UPPER REPAIR KIT



46- 99157T 2

Includes upper housing, seals, gaskets, face plate, key and impeller.

See chart for specific engine applications.

WATER PUMP UPPER REPAIR KIT



46- 60366T 1

Priced individually, sold @ multiples of 2

Mercury Branded, Clamshell Package Point of Sale Packaged.

WATER PUMP UPPER REPAIR KIT



817275A08

Includes water impeller, upper housing, face plate, face seal, drive key and gaskets.

135-300 HP FourStroke Verado (4 and 6 cylinder)

3.0L DFI and EFI outboards. See chart for specific engine applications.

WATER PUMP UPPER REPAIR KIT

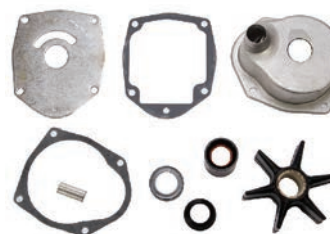

8M0061040

Includes the upper housing, new impeller, face plate, gaskets and key.

Fits the F150 EFI FourStroke outboard (s/n USA 1B905505 and newer) and the F75-115 1.7L FourStroke outboard (s/n USA 2B094996 and newer).

OUTBOARD WATER PUMP IMPELLER - MERCURY/MARINER

WATER PUMP IMPELLER



47- 16154 1

Various 25-20 Hp. FourStroke and 2-cycle outboards.
Review the Electronic Parts Catalog for your specific application.

WATER PUMP IMPELLER



47- 16154 3

Fits Mercury/Mariner shiftable 3.3 hp. (MY1993 & newer), 4/5 hp. 2-cycle (MY1987 & newer), and the 4/5/6 hp. FourStroke (MY1999 & newer).

WATER PUMP IMPELLER



47- 19453T

Various 30-60 Hp. FourStroke outboards.
Review the Electronic Parts Catalog for your specific application.

WATER PUMP IMPELLER



47- 22748

WATER PUMP IMPELLER



47- 42038Q02

Fits 6-15 hp. 2-cycle outboards with standard gearcases (USA 0A197112 & above, BEL 9461526 & above), fits 8/9.9 hp. FourStroke outboards (2004 and prior) with standard gearcases, and fits 15 hp. FourStroke outboards (323cc, MY2008 and prior) with standard gearcases.

Priced individually, sold @ multiples of 2
Quicksilver Branded, Clamshell Package Point of Sale Packaged.

WATER PUMP IMPELLER



47- 43026T 2

Fits 30/40/45/50/60 FourStroke Bigfoot, 60 (3 cyl.) BigFoot, 75-125 (all 3 & 4 cylinder models, USA A996142 & above and BEL 9483121 & above), 75/90/115 FourStroke, 150 EFI FourStroke, New! V6 (3.4L) and V8 (4.6L) FourStroke, V-200 (3.0L) DFI, V-225/250 (3.0L) and MerCruiser Alpha One Gen II drives.

WATER PUMP IMPELLER



47- 85089 10

Included in kit 47-85089T 7
Fits various 15 thru 25 hp outboards. See chart for specific engine applications.

WATER PUMP IMPELLER



47- 85647

Included in kit 47-85647T 1
Fits 3.4L outboards.

COOLING SYSTEM

WATER PUMP IMPELLER



47- 89980

Included in kit 47-89980T 1.
Fits various outboards 3.5-9.8(model 110). See chart for specific engine applications.

WATER PUMP IMPELLER



47- 89981

Included in kit 47-89981T 2
Fits various outboards 3.9-9.8(model 110). See chart for specific engine applications.

WATER PUMP IMPELLER



47- 89982

Included in kit 47-89982T 1
Fits a 20 hp (model 200) outboard, 1970-1985. See chart for serial number groupings.

WATER PUMP IMPELLER



47- 89983T

Included in kit 47-89983T 2
Fits various 30-70 hp outboards. See chart for specific engine applications.

WATER PUMP IMPELLER



47- 89984T 3

Fiberglass Insert for improved corrosion resistance in salt water.
Fits MCM & Outboard applications

WATER PUMP IMPELLER



47- 89984T 4

Fits MCM & Outboard applications. This impeller uses a brass insert. An alternate glass insert impeller 47-89984T3 is available for increased corrosion protection in salt water applications.

WATER IMPELLER REPAIR KIT



47- 89984T 5

Includes new impeller, face plate w/ face plate gaskets, drive key or pin, water tube guide sleeve, "O" rings and gearlube fill & vent screw seals.

Fits Mercury/Mariner 65 hp (4 cylinder) through V-6 outboards with short-vane impellers and fits MerCruiser I/R/MR/Alpha drives (s/n 2495186-0D469858).
Mercury Branded, Clamshell Package Point of Sale Packaged.

WATER PUMP IMPELLER



47- 95289 2

WATER PUMP IMPELLER



47-803748

Fits 9.9 hp. FourStroke (BigFoot gearcase), beginning with Model Year 2005.

WATER PUMP IMPELLER



47-803748 1

Fits Mercury/Mariner 8/9.9 hp. FourStroke outboards (standard gearcase), beginning with Model Year 2005.

WATER PUMP IMPELLER



47-888689

WATER PUMP IMPELLER



47-8M0135803

15/20 EFI FourStroke 0R833820 and above

OUTBOARD WATER PUMP IMPELLER - FORCE

WATER PUMP IMPELLER



47-89984T 3

Fiberglass Insert for improved corrosion resistance in salt water.
Fits MCM & Outboard applications

WATER PUMP IMPELLER



47-F436065-2

WATER PUMP IMPELLER



47-F462065

WATER PUMP IMPELLER



47-F84065

COOLING SYSTEM

MERCURY® OUTBOARDS

OUTBOARD WATER PUMP IMPELLER - EARLY MARINER

IMPELLER



47-80395M

IMPELLER



47-96305M

IMPELLER



47-11590M

IMPELLER



47-95611M

IMPELLER

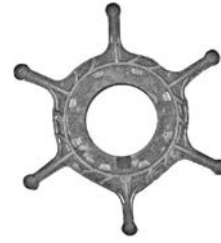

47-84027T

WATER PUMP IMPELLER



47-95533M

IMPELLER



47-84797M

IMPELLER



47-99971M

IMPELLER



47- 81423M

WATER PUMP IMPELLER



47- 97108M

OUTBOARD WATER IMPELLER REPAIR KITS - MERCURY/MARINER

WATER IMPELLER REPAIR KIT



16159A03

WATER IMPELLER REPAIR KIT



8M0080264

WATER IMPELLER REPAIR KIT



47- 19453T 2

Includes new impeller, drive key, face plate with gaskets & water tube seal. Fits 50 hp (3 cylinder) 2-cycle, OD000750-0G589999 with standard gearcase only, and also fits 55/60 hp (3 cylinder) 2-cycle, OD000750 and above with standard gearcase only. Mercury Branded, Clamshell Package Point of Sale Packaged.

WATER IMPELLER REPAIR KIT



47- 42038T 3

Includes new impeller, face plate, drive key, plate gasket and water tube guide. Fits 6-15 hp. outboards. See chart for specific engine applications. Mercury Branded, Clamshell Package Point of Sale Packaged.

WATER IMPELLER REPAIR KIT



47- 8M0100527

Fits F40-60 FourStroke Bigfoot/Command Thrust, 60 Hp. 2-cycle BigFoot OD000750 and above, all 75-115 FourStroke, 150 EFI FourStroke, 70-90 Hp. 2-cycle 0A996142 and above, 100-125 Hp. 2-cycle (4 cylinder) models having pump cover screws without insulators, V-200/225/250 (3.0L) 2-cycle outboards, all 4&6 cylinder Verado (with 4.80 dia. torpedo gearcases), and MerCruiser Alpha One Gen II drives (s/n OD469859 and above). Mercury Branded, Clamshell Package Point of Sale Packaged.

WATER IMPELLER REPAIR KIT



47- 85089T 4

Includes new impeller, face plate, drive key, plate gasket, O ring & impeller washers. Fits various 15 thru 25 hp 2 cycle outboards. See chart for specific engine applications. Mercury Branded, Clamshell Package Point of Sale Packaged.

COOLING SYSTEM

WATER IMPELLER REPAIR KIT

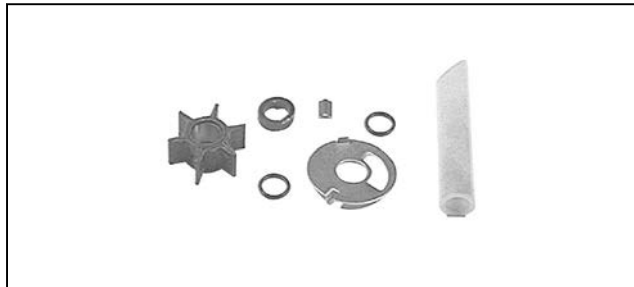

47- 89980T 1

Includes new impeller, face plate, O rings, drive key, slinger and guide sleeve. Fits various outboards 3.5-9.8(model 110). See chart for specific engine applications.

WATER IMPELLER REPAIR KIT



47- 89981T 1

Includes new impeller, face plate, "O" rings, drive key, slinger and guide sleeve. Fits Mercury/Mariner 4 HP (1 cylinder), Model 75 (7.5 HP and Model 110/9.8 HP when the water impeller ID measures .456 inches. Mercury Branded, Clamshell Package Point of Sale Packaged.

WATER IMPELLER REPAIR KIT



47- 89982T 1

Includes new impeller, face plate, plate gaskets, slinger, drive key and O rings. Fits a 20 hp (model 200) outboard, 1970-1985. See chart for serial number groupings.

WATER IMPELLER REPAIR KIT



47- 89983T 1

Includes new impeller, drive key, face plate with gaskets, "O" rings and seat assemblies.

Fits 30 JET (USA 0C159200-0G589999)
 35 hp. 2-cycle (USA 6445653 & above, BEL 9384476 & above, CAN 7209608 & above)
 40 hp. 2-cycle (all 2 cylinder through MY 1983)
 40 hp. 2-cycle (4 cylinder) (USA 0C159200 & above, BEL 9570790 & above)
 45 hp. 2-cycle (4 cylinder)
 50 hp. 2-cycle (4 cylinder with plastic water pumps)
 50/60 hp. 2-cycle (3 cylinder) (USA 6428681-0D000749, BEL 9385911-9683054, CAN 7208333 & above)
 70 hp. 2-cycle (3 cylinder) (USA 4977157-6428680, AUS 8050200 & above, BEL 9196961-9385910, CAN 7110998-7208332).
 Mercury Branded, Clamshell Package Point of Sale Packaged.

WATER IMPELLER REPAIR KIT



47- 89984T 5

Includes new impeller, face plate w/ face plate gaskets, drive key or pin, water tube guide sleeve, "O" rings and gearlube fill & vent screw seals.

Fits Mercury/Mariner 65 hp (4 cylinder) through V-6 outboards with short-vane impellers and fits MerCruiser I/R/MR/Alpha drives (s/n 2495186-0D469858). Mercury Branded, Clamshell Package Point of Sale Packaged.

WATER IMPELLER REPAIR KIT



821354A 2

Includes new impeller, drive key, face plate with gaskets & water tube seal. Fits 40/45/50 (4-Stroke) outboards. See chart for specific engine applications.

IMPELLER REPAIR KIT



821354A04

WATER IMPELLER REPAIR KIT



47-803748K01

Includes new impeller and face plate.
Fits Mercury/Mariner 8/9.9 hp. FourStroke outboards (standard gearcase), beginning with Model Year 2005.
Mercury Branded, Clamshell Package Point of Sale Packaged.

WATER IMPELLER REPAIR KIT



47-803748K02

Includes new impeller and face plate.
Fits 9.9 hp. FourStroke (BigFoot gearcase), beginning with Model Year 2005.
Mercury Branded, Clamshell Package Point of Sale Packaged.

WATER IMPELLER REPAIR KIT

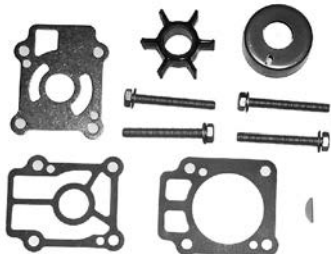

853792T01

Fits Mercury/Mariner Belgium 2-cycle, 2 cylinder/430cc outboards, 25hp. ON018456 and above and 30hp. ON001875 and above.

IMPELLER REPAIR KIT

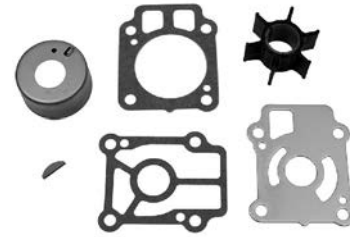

853792A07

Fits the F25/30 EFI FourStroke outboards.

WATER IMPELLER REPAIR KIT



47-8M0100526

Fits F40-60 FourStroke BigFoot/Command Thrust, 60 Hp. 2-cycle BigFoot OD000750 and above, all 75-115 FourStroke, 150 EFI FourStroke, 70-90 Hp. 2-cycle 0A996142 and above, 100-125 Hp. 2-cycle (4 cylinder) models having pump cover screws without insulators, V-200/225/250 (3.0L) 2-cycle outboards, all 4&6 cylinder Verado (with 4.80 dia. torpedo gearcases), and MerCruiser Alpha One Gen II drives (s/n OD469859 and above).
Quicksilver Branded, Clamshell Package Point of Sale Packaged.

OUTBOARD WATER IMPELLER REPAIR KITS - EARLY MARINER

REPAIR KIT



814453M

COOLING SYSTEM

MERCURY® OUTBOARDS

REPAIR KIT

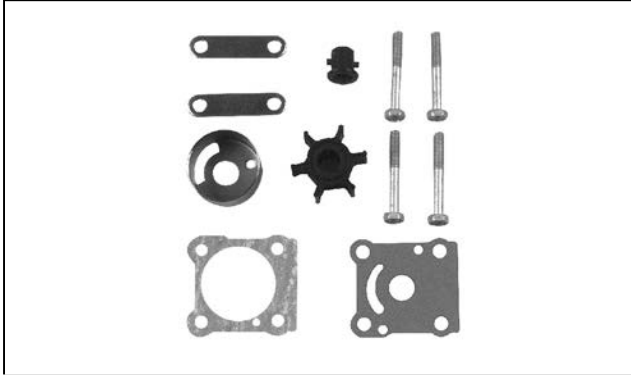

11656T

REPAIR KIT

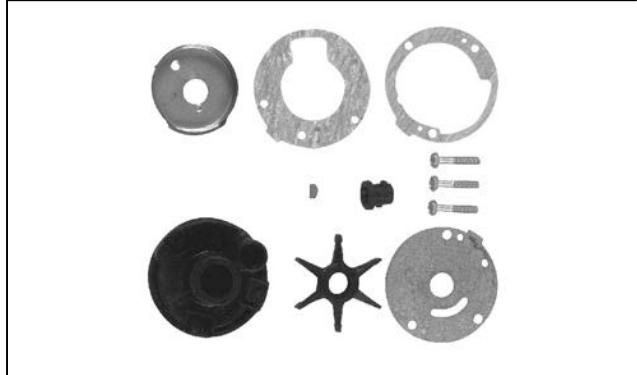

42431M

REPAIR KIT



84181T

REPAIR KIT



95661T

REPAIR KIT



46-84277T

REPAIR KIT



84363T

REPAIR KIT

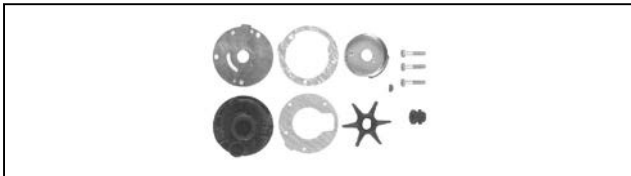

97793T

REPAIR KIT



84188T

OUTBOARD WATER PUMP UPPER HOUSINGS

COMPLETE WATER PUMP



46-812966A12

Includes both upper and lower housings, gaskets, key, O-ring, plate, and impeller. Fits various outboard models, 30-60 hp EFI and Carbureted FourStrokes. See chart for specific engine applications.

UPPER HOUSING



46-16156

UPPER HOUSING



46-16156 1

UPPER HOUSING



46-16156 2

COVER ASSEMBLY



20270A 2

COVER ASSEMBLY



46-42089A 2

UPPER HOUSING



46-77822A 1

COOLING SYSTEM

COVER ASSEMBLY



93224A 1

WATER PUMP UPPER HOUSING



46-96148T 1

UPPER HOUSING



46-99157A02

UPPER HOUSING



46-803750A05

Contains both the upper housing and liner.
 Fits Mercury/Mariner outboards, the F8/9.9 hp. FourStroke BigFoot models (209 cc., Model Year 2005 and above), F15/20 FourStroke outboards (0R235168 and above), and 9.9 hp. 2-cycle outboards (0N059858 and above) and 15/18 hp. 2-cycle outboards (0N001590 and above).

UPPER HOUSING



46-803750A02

Fits Mercury/Mariner 8/9.9 hp. FourStroke outboards (standard gearcase), beginning with Model Year 2005.

UPPER HOUSING



46-803750T05

UPPER HOUSING



817275A 1

UPPER HOUSING



817275A10

UPPER HOUSING



817275A 2

UPPER HOUSING



888686T

UPPER HOUSING



46-821351A 3

WATER PUMP REPAIR CHARTS

FourStroke Water Pump Repair Kits

Model	Model Notes	Serial # Range	Complete Pump Kit	Upper Kit	Impeller	Impeller Repair Kit	Upper Housing
2.5 FourStroke		JPN 0R131842 and up	N/A	N/A	47- 16154 3	889246A16	16156A01
3.5 FourStroke		JPN 0R131842 and up	N/A	N/A	47- 16154 3	889246A16	16156A01
4 FourStroke		JPN 0R000001 and up	N/A	N/A	47- 16154 3	16159A03	46- 16156
		BEL 0P073456 and up					
5 FourStroke		JPN 0R000001 and up	N/A	N/A	47- 16154 3	16159A03	46- 16156
		BEL 0P073456 and up					
6 FourStroke		JPN 0R000001 and up	N/A	N/A	47- 16154 3	16159A03	46- 16156
		BEL 0P073456 and up					
8 FourStroke	232cc	USA 0G760300 - 0T178499	46- 42089A 5	N/A	47- 42038Q02	47- 42038Q 3	46- 42089A 2
	232cc	USA 0H017100 - 0H017349					
8 FourStroke	323cc, Standard	BEL 0P075166 - 0P325499	46- 42089A 5	N/A	47- 42038Q02	47- 42038Q 3	46- 42089A 2
8 FourStroke		USA 0R042475 and up	46- 803750A03	N/A	47- 803748 1	47- 803748Q01	46- 803750A02(2)
		BEL 0P325500 and up					
9.9 FourStroke	232cc	USA 0H000058 - 0H016909	46- 42089A 5	N/A	47- 42038Q02	47- 42038Q 3	46- 42089A 2
9.9 FourStroke	323cc, Standard	USA 0G760300 - 0T979999	46- 42089A 5	N/A	47- 42038Q02	47- 42038Q 3	46- 42089A 2
	323cc, Standard	BEL 0P075166 - 0P325499					
9.9 FourStroke	323cc, BigFoot	USA 0G760300 - 0T979999	N/A	46- 99157T 2	47- 85089 10	N/A	46- 99157A02
	323cc, BigFoot	BEL 0P075166 - 0P325499					
9.9 FourStroke	Standard gearcase	JPN 0R042475 and up	46- 803750A03	N/A	47- 803748 1	47- 803748Q01	46- 803750A02
		BEL 0P325500 and up					
9.9 FourStroke	BigFoot gearcase	JPN 0R042475 and up	N/A	N/A	47- 803748	47- 803748Q02	46- 803750A05(2)
		BEL 0P325500 and up					
15 FourStroke	323cc, Standard	USA 0G590000 - 1B727495	46- 42089A 5	N/A	47- 42038Q02	47- 42038Q 3	46- 42089A 2
		BEL 9973100 and up					
15 FourStroke	323cc, BigFoot	USA 0G590000 - 1B727495	N/A	46- 99157T 2	47- 85089 10	N/A	46- 99157A02
		BEL 9973100 and up					

Not all parts listed are available for the European, C.I.S., Africa and Middle East Markets. For more information, please contact your local Mercury, Mariner, MerCruiser or Quicksilver Office.

COOLING SYSTEM

MERCURY® OUTBOARDS

Model	Model Notes	Serial # Range	Complete Pump Kit	Upper Kit	Impeller	Impeller Repair Kit	Upper Housing
15 FourStroke	351cc	JPN 0R235949 - 0R833819	46-8M0122064	N/A	47-803748	N/A	46-803750A05
15 EFI FourStroke		JPN 0R833820 and up	8M0135821 8M0137849 (Chrome)	N/A	8M0135803	N/A	8M0134492
20 FourStroke	351cc	JPN 0R235168 - 0R833819	46-8M0122064	N/A	47-803748	N/A	46-803750A05
20 EFI FourStroke		JPN 0R833820 and up	8M0135821 8M0137849 (Chrome)	N/A	8M0135803	N/A	8M0134492
25 FourStroke	Carb	USA 0G590000 - 0T408999 BEL 9973100 - 0P153499	N/A	N/A	47-85089 10	821354A 2	46-821351A 3
25 FourStroke	Carb	USA 0T409000 - 1B344298 BEL 0P153500 - 0P388282	N/A	N/A	47-85089 10	821354A04	46-821351A 3
25 FourStroke	EFI	JPN 0R106999 and up	N/A	N/A	47-16154 1	853792A07	46-803750T05
30 FourStroke	Carb, Standard	USA 0G760300 - 0T408999 BEL 0P153500 - 0P153499	N/A	N/A	47-85089 10	821354A 2	46-821351A 3
30 FourStroke	Carb, Standard	USA 0T409000 and up BEL 0P153500 and up	N/A	N/A	47-85089 10	821354A04	46-821351A 3
30 FourStroke	EFI	USA 0T409000 - 1B226999	N/A	N/A	47-85089 10	821354A04	46-821351A 3
30 FourStroke	EFI	JPN 0R106999 and up	N/A	N/A	47-16154 1	853792A07	46-803750T05
40 FourStroke	Carb, 3 cylinder, Standard	USA 0G760300 - 0T408999 BEL 0P153500 - 0P153499	N/A	N/A	47-85089 10	821354A 2	46-821351A 3
40 FourStroke	Carb, 3 cylinder, Standard	USA 0T409000 and up BEL 0P153500 and up	N/A	N/A	47-85089 10	821354A04	46-821351A 3
40 FourStroke	EFI, 3 cylinder, Standard	USA 0T409000 - 1B226999	N/A	N/A	47-85089 10	821354A04	46-821351A 3
40 FourStroke	EFI, 3 cyl., Short Shaft	USA 1B227000 - 1B344398	N/A	N/A	47-85089 10	821354A04	46-821351A 3
40 FourStroke	EFI, 3cyl., Short Shaft	CHN 1C000001 - 1C049738	N/A	N/A	47-85089 10	821354A04	46-821351A 3
40 FourStroke	EFI, 3cyl., Long Shaft	CHN 1C000001 - 1C049738	46-812966A12	N/A	47-19453T	N/A	46-812966A12
40 FourStroke	EFI, 3 cyl.	CHN 1C049739 and up	46-812966A12	N/A	47-19453T	N/A	46-812966A12
40 FourStroke	Carb, 4 cylinder, BigFoot	USA 0T228405 - 0T598999 BEL 0P094500 - 0P206999	46-8M0113801	N/A	47-43026T 2	47-8M0100527	817275A 2
40 FourStroke	EFI, 4 cylinder, BigFoot	USA 0T409000 - 1B344398 BEL 0P153500 - 0P400999 CHN 1C000001 - 1C033810	46-8M0113801	N/A	47-43026T 2	47-8M0100527	817275A 2
40 FourStroke	EFI, 4 cylinder, BigFoot	CHN 1C033811 - 1C050251 BEL 0P401000 - 0P515896	46-8M0113799	N/A	47-43026T 2	47-8M0100527	817275A 2
40 FourStroke	EFI, 4 cylinder, BigFoot	CHN 1C050252 and up	46-8M0113801	N/A	47-43026T 2	47-8M0100527	817275 2
45 FourStroke	4 cylinder Bodensee, Standard	USA 0G231123 - 0T178499	N/A	N/A	47-85089 10	821354A 2	46-821351A 3
45 FourStroke	4 cylinder, Bodensee, BigFoot	USA 0G231123 - 0T178499	46-8M0113799	N/A	47-43026T 2	47-8M0100527	817275A 2
50 FourStroke	Standard	USA 0G231123 - 0T178499	N/A	N/A	47-85089 10	821354A 2	46-821351A 3
50 FourStroke	BigFoot	USA 0G231123 - 0T178499	46-8M0113799	N/A	47-43026T 2	47-8M0100527	817275A 2
50 FourStroke	Carb, Standard, 996cc	USA 0T178500 - 0T598999 BEL 0P094500 - 0P206999	46-812966A12	N/A	47-19453T	N/A	46-812966A12
50 FourStroke	Carb, BigFoot, 996cc	USA 0T178500 - 0T598999 BEL 0P094500 - 0P206999	46-8M0113801	N/A	47-43026T 2	47-8M0100527	817275A 2
50 FourStroke	EFI, Standard, 996cc	USA 0T409000 - 1B344398 BEL 0P153500 - 0P400999 CHN 1C000001 and up	46-812966A12	N/A	47-19453T	N/A	46-812966A12
50 FourStroke	EFI, BigFoot, 996cc	USA 0T409000 - 1B344398 BEL 0P153500 - 0P400999 CHN 1C000001 - 1C033810	46-8M0113801	N/A	47-43026T 2	47-8M0100527	817275A 2
50 FourStroke	EFI, BigFoot, 996cc	CHN 1C033811 - 1C050251 BEL 0P401000 - 0P515896	46-8M0113799	N/A	47-43026T 2	47-8M0100527	817275A 2
50 FourStroke	EFI, BigFoot, 996cc	CHN 1C050252 and up	46-8M0113801	N/A	47-43026T 2	47-8M0100527	817275A 2
60 FourStroke	Carb, Standard, 996cc	USA 0T178500 - 0T598999 BEL 0P094500 - 0P206999	46-812966A12	N/A	47-19453T	N/A	46-812966A12

COOLING SYSTEM

MERCURY® OUTBOARDS

Model	Model Notes	Serial # Range	Complete Pump Kit	Upper Kit	Impeller	Impeller Repair Kit	Upper Housing
60 FourStroke	Carb, BigFoot, 996cc	USA 0T178500 - 0T598999 BEL 0P094500 - 0P206999	46 8M0113801	N/A	47- 43026T 2	47- 8M0100527	817275A 2
60 FourStroke	EFI, Standard, 996cc	USA 0T409000 - 1B344398 BEL 0P153500 and up CHN 1C000001 and up	46 812966A12	N/A	47- 19453T	N/A	46 812966A12
60 FourStroke	EFI, BigFoot, 996cc	USA 0T409000 - 1B344398 BEL 0P153500 - 0P400999 CHN 1C000001 - 1C033810	46 8M0113801	N/A	47- 43026T 2	47- 8M0100527	817275A 2
60 FourStroke	EFI, BigFoot, 996cc	CHN 1C033811 - 1C050251 BEL 0P401000 - 0P515896	46 8M0113799	N/A	47- 43026T 2	47- 8M0100527	817275A 2
60 FourStroke	EFI, BigFoot, 996cc	CHN 1C050252 and up	46 8M0113801	N/A	47- 43026T 2	47- 8M0100527	817275A 2
75 FourStroke	1596cc	USA 0G960500 - 1B366822	46 8M0113799	N/A	47- 43026T 2	47- 8M0100527	817275A 2
75 FourStroke	1731cc	USA 1B366823 - 2B094995 BEL 0P459572 and up	46 8M0113799	N/A	47- 43026T 2	47- 8M0100527	817275A 2
75/80 FourStroke	2.1L	USA 2B094996 and up	8M0094529	8M0061040	47- 43026T 2	47- 8M0100526	817275A10
90 FourStroke	1596cc	USA 0G960500 - 1B366822	46 8M0113799	N/A	47- 43026T 2	47- 8M0100527	817275A 2
90 FourStroke	1731cc	USA 1B366823 - 2B094995 BEL 0P459572 and up	46 8M0113799	N/A	47- 43026T 2	47- 8M0100527	817275A 2
90/100 FourStroke	2.1L	USA 2B094996 and up	8M0094529	8M0061040	47- 43026T 2	47- 8M0100526	817275A10
115 FourStroke	1741cc	USA 0T178500 - 1B366822	46 8M0113799	N/A	47- 43026T 2	47- 8M0100527	817275A 2
115 FourStroke	1731cc	USA 1B366823 - 2B094995	46 8M0113799	N/A	47- 43026T 2	47- 8M0100527	817275A 2
115 FourStroke	2.1L	USA 2B094996 and up	8M0094529	8M0061040	47- 43026T 2	47- 8M0100526	817275A10
135 FourStroke	4 cyl., Verado	USA 1B227000 and up	817275A09	817275A08	47- 43026T 2	47- 8M0100527	817275A 2
150 FourStroke	EFI	USA 1B905505 and up	8M0094529		47- 43026T 2		817275A10
150 FourStroke	4 cyl., Verado	USA 1B227000 and up	817275A09	817275A08	47- 43026T 2	47- 8M0100527	817275A 2
175 FourStroke	4 cyl., Verado	USA 1B227000 and up	817275A09	817275A08	47- 43026T 2	47- 8M0100527	817275A 2
200 FourStroke	4 cyl., Verado	USA 1B517159 and up	817275A09	817275A08	47- 43026T 2	47- 8M0100527	817275A 2
200, 6 cyl., Verado	4.8 inch Torpedo	USA 0T980000 and up	817275A09	817275A08	47- 43026T 2	47- 8M0100527	817275A 2
	5.44 inch Torpedo		8M0078858		47- 43026T 2		817275A 1
225 FourStroke	EFI	USA 0T653945 and up	N/A	N/A	47- 888689	888687A 1	888686T
225, 6 cyl., Verado	4.8 inch Torpedo	USA 0T980000 and up	817275A09	817275A08	47- 43026T 2	47- 8M0100527	817275A 2
	5.44 inch Torpedo		8M0078858		47- 43026T 2		817275A 1
250, 6 cyl., Verado	4.8 inch Torpedo	USA 0T980000 and up	817275A09	817275A08	47- 43026T 2	47- 8M0100527	817275A 2
	5.44 inch Torpedo		8M0078858		47- 43026T 2		817275A 1
275, 6 cyl., Verado	4.8 inch Torpedo	USA 0T980000 and up	817275A09	817275A08	47- 43026T 2	47- 8M0100527	817275A 2
	5.44 inch Torpedo		8M0078858		47- 43026T 2		817275A 1
300, 6 cyl., Verado	4.8 inch Torpedo	USA 1B517434 and up	817275A09	817275A08	47- 43026T 2	47- 8M0100527	817275A 2
	5.44 inch Torpedo		8M0078858		47- 43026T 2		817275A 1

(1) Base Housing only, seal not included.

(2) Upper Housing only, insert cup not included.

2-Cycle Water Pump Repair Kits

Model	Serial # Range	Complete Pump Kit	Upper Kit	Impeller	Impeller Repair Kit	Upper Housing
2 hp (pump on top of gearcase)		0G413201 and up		N.L.A.		
2.2M		8075603 and up		47- 95289 2		
2.5/3 hp		0A855097 and up		47- 95289 2		
3.3 w/shift		0D901217 and up		47- 16154 3	8M0080264	46- 16156 1
3.3 non-shift		0D901217 and up		47- 95289 2		
3.5		6202173 and up	N.L.A.	47- 89980		N.L.A.
3.6	USA	5404657 and up	N.L.A.	47- 89980		N.L.A.
	BEL	9252831 and up				
	CAN	7145388 and up				

Not all parts listed are available for the European, C.I.S., Africa and Middle East Markets.
For more information, please contact your local Mercury, Mariner, MerCruiser or Quicksilver Office.

COOLING SYSTEM

MERCURY® OUTBOARDS

Model	Serial # Range	Complete Pump Kit	Upper Kit	Impeller	Impeller Repair Kit	Upper Housing
3.9(14)	1655013 - 2200317 2200318 - 2498135	46-46893A 6	N/A	47-22748	N/A	N.L.A.
4 (1 Cyl.) .438 inch Imp. I.D.	USA 5595532 - 0A809600 AUS 8068065 and up BEL 9258281 - 9477829 CAN 7143688 and up	N.L.A.	N/A	47-89980	47-89980T 1	93224A 1
4 (1 Cyl.) .456 inch Imp. I.D.	USA 5595532 and up AUS 8068065 and up BEL 9258281 and up CAN 7143688 and up	46-70941A 3	N/A	47-89981	47-89981T 1	93224A 1
4/5 (1 Cyl.)	USA 0A809601 and up BEL 9477830 and up	N/A	N/A	47-16154 3	N/A	46-16156
40/4 (2 Cyl.), GNAT, .438 inch Imp. I.D.	BEL 9075839 - 9256980 CAN 7085673 - 7146487	N.L.A.	N/A	47-89980	N/A	N.L.A.
40/4 (2 Cyl.), GNAT, .456 inch Imp. I.D.	BEL 9075839 - 9256980 CAN 7085673 - 7146487	N.L.A.	N/A	47-89981	N/A	N.L.A.
40/4 (2 Cyl.)	USA 5589202 and up AUS 8065265 and up BEL 9256981 and up CAN 7146488 and up	N.L.A.	N/A	47-89980	N/A	N.L.A.
45/4.5 (1 Cyl)	USA 4107220 - 5595531 AUS 8026540 - 8068064 BEL 9072179 - 9258280 CAN 7045758 - 7147237	46-70941A 3	N/A	47-89981	47-89981T 1	93224A 1
45/4.5 (1 Cyl), .438 inch Imp. I.D.	USA 5595532 and up AUS 8068065 and up BEL 9258281 and up CAN 7147238 and up	N.L.A.	N/A	47-89980	47-89980T 1	93224A 1
45/4.5 (1 Cyl), .456 inch Imp. I.D.	USA 5595532 and up AUS 8068065 and up BEL 9258281 and up CAN 7147238 and up	46-70941A 3	N/A	47-89981	47-89981T 1	93224A 1
60 (6 hp)	1408611 - 1490054	N.L.A.	N/A	47-22748	N/A	N.L.A.
60 (6 hp)	1490055 - 1582402	N.L.A.	N/A	47-22748	N/A	N.L.A.
60 (6 hp)(12)	1582403 - 1916138	46-46893A 6	N/A	47-22748	N/A	N.L.A.
60 (6 hp)(12)	1916139 - 2193817	46-46893A 6	N/A	47-89981	N/A	N.L.A.
60 (6 hp)	2193818 - 2529894	46-46893A 6	N/A	47-89981	N/A	93224A 1
60J (6 hp)	2385673 - 2387383	N/A	N/A	47-89981	N/A	N.L.A.
6	USA 0A197112 - 0T800749 BEL 9461526 and up	46-42089A 5	N/A	47-42038Q02	47-42038T 3	46-42089A 2
75 (7.5 hp)	USA 2529895 - 4131609 AUS 8015315 - 8028839 BEL 9043194 - 9079488 CAN 7028598 - 7050207	46-46893A 6	N/A	47-89981	N/A	93224A 1
75 (7.5 hp)	USA 4131610 - 5226934 AUS 8028840 - 8058019 BEL 9079489 - 9219255 CAN 7050206 - 7136037	46-70941A 3	N/A	47-89981	47-89981T 1	93224A 1
7.5 HP., .438 inch Imp. I.D.	USA 5206550 and up AUS 8057545 and up BEL 9217756 and up CAN 7125388 and up	N.L.A.	N/A	47-89980	47-89980T 1	93224A 1
7.5 HP., .456 inch Imp. I.D.	USA 5206550 and up AUS 8057545 and up	46-70941A 3	N/A	47-89981	47-89981T 1	93224A 1

COOLING SYSTEM

MERCURY® OUTBOARDS

Model	Serial # Range	Complete Pump Kit	Upper Kit	Impeller	Impeller Repair Kit	Upper Housing
8	BEL 9217756 and up					
	CAN 7125388 and up					
	USA 0A197112 and up	46-42089A 5	N/A	47-42038Q02	47-42038T 3	46-42089A 2
	BEL 9461526 and up					
110 (9.8 hp)(13)	1865779 - 2196388	46-46893A 6	N/A	47-89981	N/A	N.L.A.
110 (9.8 hp)	2196389 - 3795657	46-46893A 6	N/A	47-89981	N/A	93224A 1
110 (9.8 hp)	USA 3795658 - 4126459	46-46893A 6	N/A	47-89981	N/A	93224A 1
	AUS 8015040 - 8028439					
	BEL 9041439 - 9078138					
	CAN 7027323 - 7049107					
	USA 4126460 - 5206549	46-70941A 3	N/A	47-89981	47-89981T 1	93224A 1
110 (9.8 hp)	AUS 8028440 - 8057554					
	BEL 9078139 - 9217755					
	CAN 7049108 - 7125387					
	USA 5206550 and up	N.L.A.	N/A	47-89980	47-89980T 1	93224A 1
9.8 HP., .438 inch Imp. I.D.	AUS 8057545 and up					
	BEL 9217756 and up					
	CAN 7125388 and up					
	USA 5206550 and up	46-70941A 3	N/A	47-89981	47-89981T 1	93224A 1
9.8 HP., .456 inch Imp. I.D.	AUS 8057545 and up					
	BEL 9217756 and up					
	CAN 7125388 and up					
	USA 5206550 and up	46-70941A 3	N/A	47-89981	47-89981T 1	93224A 1
9.9	USA 0A197112 and up	46-42089A 5	N/A	47-42038Q02	47-42038T 3	46-42089A 2
	BEL 9461526 and up					
XR10/ Sea Pro, 10 Magnum & Marathon	USA 0D038000 and up	46-42089A 5	N/A	47-42038Q02	47-42038T 3	46-42089A 2
	BEL 9596000 and up					
15	USA 0B292414 and up	46-42089A 5	N/A	47-42038Q02	47-42038T 3	46-42089A 2
	BEL 9542620 and up					
15 Sea Pro & Marathon	USA 0G044365 and up	46-42089A 5	N/A	47-42038Q02	47-42038T 3	46-42089A 2
	BEL 9927000 and up					
15XD/BigFoot	BEL 9927000 and up	N/A	46-99157T 2	47-85089 10	47-85089T 4	46-99157A02
18/18XD	USA 5837437 and up	N/A	46-99157T 2	47-85089 10	47-85089T 4	46-99157A02
	AUS 8071973 and up					
	BEL 9308306 and up					
200 (20 HP.)	1558310 - 1866495	N/A	N/A	N.L.A.	N/A	N.L.A.
200 (20 HP.)	1866496 - 2296266	N.L.A.	N/A	N.L.A.	N/A	N.L.A.
200 (20 HP.)(2)	2296267 - 2827676	N.L.A.	N/A	N.L.A.	N/A	N.L.A.
200 (20 HP.)(4)	2296267 - 2827676	N.L.A.	N/A	N.L.A.	N/A	N.L.A.
200 (20 HP.)	USA 2827677 - 6443972	46-48744A 3	N/A	47-89982	47-89982T 1	N.L.A.
	AUS 8006265 and up					
	BEL 9016254 - 9415100					
	CAN 7012358 - 7209532					
20/20XD	USA 6443973 - 0T800749	N/A	46-99157T 2	47-85089 10	47-85089T 4	46-99157A02
	BEL 9415101 and up					
	CAN 7209533 and up					
25/25XD	USA 5705532 and up	N/A	46-99157T 2	47-85089 10	47-85089T 4	46-99157A02
	AUS 8073158 and up					
	BEL 9315316 and up					
25 Sea Pro/Marathon & Super 15	USA 0B238464 and up	N/A	46-99157T 2	47-85089 10	47-85089T 4	46-99157A02
	BEL 9507381 and up					
	CAN 0A730007 and up					
25 (3 Cyl.)	USA 0E268781 and up	N/A	46-99157T 2	47-85089 10	47-85089T 4	46-99157A02
300 (30 hp)	1271884 - 1448139	N/A	N/A	47-89983T	N/A	20270A 2
300 (2 Cyl.), 644cc	USA 0G053314 - 0T598999	N/A	N/A	47-85089 10	821354A 2	46-821351A 3

Not all parts listed are available for the European, C.I.S., Africa and Middle East Markets.
 For more information, please contact your local Mercury, Mariner, MerCruiser or Quicksilver Office.

COOLING SYSTEM

Model	Serial # Range	Complete Pump Kit	Upper Kit	Impeller	Impeller Repair Kit	Upper Housing
30 (2 Cyl.), 430cc, Lightning	USA 0G575500 and up	N/A	N/A	47- 16154 1	853792T01	46- 16156 2
30 Jet	USA 0C159200 - 0G589999	46- 77177A 3	46- 60366T 1	47- 89983T	47- 89983T 1	46- 77822A 1
30 Jet	USA 0G590000 and up	N/A	N/A	47- 85089 10	821354A 2	46- 821351A 3
350 (35 HP)	1571114 - 1960826	N/A	N/A	47- 89983T	N/A	20270A 2
350 (35 HP)(2)	1960827 - 2453068	N/A	N/A	47- 89983T	N/A	46- 60366Q 1
350 (35 HP)(4)	1960827 - 2453068	N/A	46- 60366T 1	47- 89983T	N/A	46- 77822A 1
35 (2 Cyl.)	USA 6445653 and up	46- 77177A 3	46- 60366T 1	47- 89983T	47- 89983T 1	46- 77822A 1
	BEL 9384476 and up					
	CAN 7209608 and up					
400 (40 hp)	1279685 - 1476509	N/A	N/A	47- 89983T	N/A	20270A 2
400/402(40hp)	USA 2874704 - 4362214	N/A	46- 60366T 1	47- 89983T	47- 89983T 1	46- 77822A 1
	AUS 8002335 - 8036449					
	BEL 3339688 - 9108563					
	CAN 3340783 - 7070272					
402 (40 hp)	USA 4362215 - 4860102	N/A	46- 60366T 1	47- 89983T	47- 89983T 1	46- 77822A 1
	AUS 8036450 - 8052124					
	BEL 9108564 - 9184450					
	CAN 7070273 - 7112422					
402/40(2 Cyl), Through 1983	USA 4860103 and up	46- 77177A 3	46- 60366T 1	47- 89983T	47- 89983T 1	46- 77822A 1
	AUS 8052125 and up					
	BEL 9184451 and up					
	CAN 7112423 and up					
40 (2 Cyl.), 1994 & Above, 644cc	USA 0G053314 and up	N/A	N/A	47- 85089 10	821354A 2	46- 821351A 3
40 (3 Cyl.)	USA 0G531301 and up	N/A	N/A	47- 85089 10	821354A 2	46- 821351A 3
	BEL 9973100 and up					
40 (4 Cyl.)	USA 0C159200 and up	46- 77177A 3	46- 60366T 1	47- 89983T	47- 89983T 1	46- 77822A 1
	BEL 9570790 and up					
45 JET	USA 0D000750 and up	46- 812966A12	N/A	47- 19453T	47- 19453T 2	46- 812966A12
45 (4 Cyl.)	USA 5531630 and up	46- 77177A 3	46- 60366T 1	47- 89983T	47- 89983T 1	46- 77822A 1
	AUS 8063985 and up					
	BEL 9248006 and up					
	CAN 7143688 and up					
500 (50 hp)	1421113 - 1460498	N/A	N/A	47- 89983T	N/A	20270A 2
500 (50 hp)	1477910 - 1521913	N/A	N/A	47- 89983T	N/A	N.L.A.
500 (50 hp)	USA 1521914 - 2305100	N/A	N/A	47- 89983T	N/A	46- 60366Q 1
	CAN 1755549 - 2305100					
500 (50 hp)(2)	USA 2305101 - 2478119	N/A	N/A	47- 89983T	N/A	46- 60366Q 1
500 (50 hp)(4)	USA 2305101 - 2478119	N/A	46- 60366T 1	47- 89983T	47- 89983T 1	46- 77822A 1
500 (50 hp)(2)	CAN 2305101 - 2308830	N/A	N/A	47- 89983T	N/A	46- 60366Q 1
500 (50 hp)(4)	CAN 2305101 - 2308830	N/A	46- 60366T 1	47- 89983T	47- 89983T 1	46- 77822A 1
500 (50 hp)	USA 2514919 - 4357639	N/A	46- 60366T 1	47- 89983T	47- 89983T 1	46- 77822A 1
	AUS 2863739 - 8030089					
	BEL 9001581 - 9107213					
	CAN 2519919 - 7068997					
500/50 HP. (4 Cyl.)	USA 4357640 - 5531629	46- 73640A 2	46- 60366T 1	47- 89983T	47- 89983T 1	46- 77822A 1
	AUS 8030090 - 8063984					
	BEL 9107214 - 9248005					
	CAN 7068998 - 7143687					
50 HP. (4 Cyl)	USA 5531630 and up	46- 77177A 3	46- 60366T 1	47- 89983T	47- 89983T 1	46- 77822A 1
	AUS 8063985 and up					
	BEL 9248006 and up					
	CAN 7143688 and up					

COOLING SYSTEM

MERCURY® OUTBOARDS

Model	Serial # Range	Complete Pump Kit	Upper Kit	Impeller	Impeller Repair Kit	Upper Housing
50 HP. (3 Cyl)	USA 6428681 - 0D000749	46-77177A 3	46-60366T 1	47-89983T	47-89983T 1	46-77822A 1
	BEL 9385911 - 9683054					
	CAN 7208333 and up					
50 HP. (3 Cyl)	USA 0D000750 - 0G589999	46-812966A12	N/A	47-19453T	47-19453T 2	46-812966A12
	BEL 9683055 - 9973099					
50 HP. (3 Cyl)	USA 0G590000 and up	N/A	N/A	47-85089 10	821354A 2	46-821351A 3
	BEL 9973100 and up					
55 HP. (3 Cyl)	USA 0D000750 and up	46-812966A12	N/A	47-19453T	47-19453T 2	46-812966A12
	BEL 9741042 and up					
600 (60 hp)(6 Cyl.)	1303411 - 1542744	N/A	N/A	N.L.A.	N/A	N.L.A.
60 HP. (3 Cyl)	USA 6428681 - 0D000749	46-77177A 3	46-60366T 1	47-89983T	47-89983T 1	46-77822A 1
	BEL 9385911 - 9683054					
	CAN 7208333 and up					
60 HP. (3 Cyl), Standard	USA 0D000750 and up	46-812966A12	N/A	47-19453T	47-19453T 2	46-812966A12
	BEL 9683055 and up					
60 HP. (3 Cyl), BigFoot	USA 0D000750 and up	46-8M0113799	N/A	47-43026T 2	47-8M0100527	817275A 2
	BEL 9683055 and up					
650 (65 hp)(4 Cyl.)(2)	1542745 - 2803561	N/A	46-96148A 8	47-89984T 4	47-89984T 5	46-96148T 1
650 (65 hp)(4 Cyl.)(4)	1542745 - 2803561	N/A	46-96148A 8	47-89984T 4	47-89984T 5	46-96148T 1
650 (65 hp)(4 Cyl.)	2803562 - 2874263	N/A	46-96148A 8	47-89984T 4	47-89984T 5	46-96148T 1
650 (65 hp)(4 Cyl.)	2997439 - 3293183	N/A	46-96148A 8	47-89984T 4	47-89984T 5	46-96148T 1
65 HP (3 Cyl)	USA 3293184 - 4382056	N/A	46-60366T 1	47-89983T	N/A	46-77822A 1
	AUS 8006640 - 8042349					
	BEL 9020074 - 9112988					
	CAN 7013633 - 7073472					
65 HP (3 Cyl)	USA 4382057 - 4571651	N/A	46-60366T 1	47-89983T	N/A	46-77822A 1
	BEL 9112989 - 9135824					
	CAN 7073473 - 7087822					
65 JET	USA 0D283222 and up	46-8M0113799	N/A	47-43026T 2	47-8M0100527	817275A 2
	BEL 9793577 and up					
700 (70 hp)(6 Cyl.)	1266411 - 1413610	N/A	N/A	N.L.A.	N/A	N.L.A.
700 (70 hp)(6 Cyl.)	1413611 - 1436114	N/A	N/A	47-89984T 4	N/A	N.L.A.
700 (70 hp)(6 Cyl.)	1482212 - 1503458	N/A	N/A	47-89984T 4	N/A	N.L.A.
700 E-2 (70 hp)(6 Cyl.)	1503459 - 1503958	N/A	N/A	47-89984T 4	N/A	N.L.A.
700 EL-2 (70 hp)(6 Cyl.)	1503459 - 1505110	N/A	N/A	47-89984T 4	N/A	N.L.A.
700 E-2 (70 hp)(6 Cyl.)(11)	1503959 - 1566239	N/A	46-96148A 8	47-89984T 4	47-89984T 5	46-96148T 1
700 EL-2 (70 hp)(6 Cyl.)(11)	1505111 - 1566239	N/A	46-96148A 8	47-89984T 4	47-89984T 5	46-96148T 1
70 HP (3 Cyl)	USA 4571652 - 4977156	46-73640A 2	46-60366T 1	47-89983T	N/A	46-77822A 1
	AUS 8042350 - 8050199					
	BEL 9135825 - 9196960					
	CAN 7087823 - 7110997					
70 HP (3 Cyl)	USA 4977157 - 6428680	46-77177A 3	46-60366T 1	47-89983T	47-89983T 1	46-77822A 1
	AUS 8050200 and up					
	BEL 9196961 - 9385910					
	CAN 7110998 - 7208332					
70 HP (3 Cyl)(6)	USA 0A996142 - 0C221999	46-8M0113799	N/A	47-43026T 2	N/A	817275A 2
	BEL 9483121 - 9589038					
70 HP (3 Cyl)(5)	USA 0A996142 - 0C221999	46-8M0113799	N/A	47-43026T 2	47-8M0100527	817275A 2
	BEL 9483121 - 9589038					
75 HP (4 Cyl)	USA 6432901 and up		46-96148A 8	47-89984T 4	47-89984T 5	46-96148T 1
	BEL 9393856 and up					
	CAN 7208573 and up					
75 HP (3 Cyl)(6)	USA 0C222000 and up	46-8M0113799	N/A	47-43026T 2	N/A	817275A 2
	BEL 9589039 and up					

Not all parts listed are available for the European, C.I.S., Africa and Middle East Markets.
For more information, please contact your local Mercury, Mariner, MerCruiser or Quicksilver Office.

COOLING SYSTEM

Model	Serial # Range	Complete Pump Kit	Upper Kit	Impeller	Impeller Repair Kit	Upper Housing
75 HP (3 Cyl)(5)	USA 0C222000 and up	46 8M0113799	N/A	47 43026T 2	47 8M0100527	817275A 2
	BEL 9589039 and up					
75 (3 Cyl) Optimax	USA 0T980000 and up	46 8M0113799	N/A	47 43026T 2	47 8M0100527	817275A 2
800 (80 hp)(6 Cyl.)	1335465 - 1398629	N/A	N/A	47 89984T 4	N/A	N.L.A.
800 (80 hp)(6 Cyl.)	1398630 - 1566239	N/A	N/A	47 89984T 4	N/A	N.L.A.
800 (80 hp)(4 Cyl.)	2559001 - 3144218	N/A	46 96148A 8	47 89984T 4	47 89984T 5	46 96148T 1
800 (80 hp)(4 Cyl.)	3144219 - 3493912	N/A	46 96148A 8	47 89984T 4	47 89984T 5	46 96148T 1
80 HP (4 Cyl)	USA 4831999 - 6432900	N/A	46 96148A 8	47 89984T 4	47 89984T 5	46 96148T 1
	AUS 8050200 and up					
	BEL 9177626 - 9393855					
	CAN 7110998 - 7208572					
80 HP (3 Cyl)(6)	USA 0A996142 - 0C221999	46 8M0113799	N/A	47 43026T 2	N/A	817275A 2
	BEL 9483121 - 9589038					
80 HP (3 Cyl)(5)	USA 0A996142 - 0C221999	46 8M0113799	N/A	47 43026T 2	47 8M0100527	817275A 2
	BEL 9483121 - 9589038					
80 JET	USA 0D283222 and up	46 8M0113799	N/A	47 43026T 2	47 8M0100527	817275A 2
	BEL 9793577 and up					
850 E, EL (85 hp)(6 Cyl.)	1460999 - 1567039	N/A	N/A	47 89984T 4	N/A	N.L.A.
850 E-1, EL-1 (85 hp)(6 Cyl.)(11)	1566240 - 1766823	N/A	46 96148A 8	47 89984T 4	47 89984T 5	46 96148T 1
850, 850 XS (85 hp)(4 Cyl.)	USA 3493913 - 4590511	N/A	46 96148A 8	47 89984T 4	47 89984T 5	46 96148T 1
	BEL 9011604 - 9139349					
	CAN 7010108 - 7091097					
850 XS (85 hp)(4 Cyl.)	USA 3493913 - 4831998	N/A	46 96148A 8	47 89984T 4	47 89984T 5	46 96148T 1
	AUS 8043775 - 8050199					
	BEL 9011604 - 9177625					
	CAN 7010108 - 7110997					
850 XS (85 hp)(4 Cyl.)	USA 3493913 - 4831998	N/A	46 96148A 8	47 89984T 4	47 89984T 5	46 96148T 1
	AUS 8043775 - 8050199					
	BEL 9011604 - 9177625					
	CAN 7010108 - 7110997					
900 (90 hp)(6 Cyl.)(11)	1766824 - 1869775	N/A	46 96148A 8	47 89984T 4	47 89984T 5	46 96148T 1
90 HP (6 Cyl)	USA 4845301 and up	N/A	46 96148A 8	47 89984T 4	47 89984T 5	46 96148T 1
	AUS 8060545 and up					
	CAN 7111698 and up					
90 HP (3 Cyl)(6)	USA 0A996142 and up	46 8M0113799	N/A	47 43026T 2	N/A	817275A 2
	BEL 9483121 and up					
90 HP (3 Cyl)(5)	USA 0A996142 and up	46 8M0113799	N/A	47 43026T 2	47 8M0100527	817275A 2
	BEL 9483121 and up					
115 (3 Cyl) Optimax	USA 0T801000 and up	46 8M0113799	N/A	47 43026T 2	47 8M0100527	817275A 2
950 (95 hp)(6 Cyl.)(11)	1869776 - 2318585	N/A	46 96148A 8	47 89984T 4	47 89984T 5	46 96148T 1
1000 (100 hp)(6 Cyl.)	1464949 - 1503331	N/A		47 89984T 4	N/A	N.L.A.
1000 (100 hp)(6 Cyl.)(11)	1503332 - 2318585	N/A	46 96148A 8	47 89984T 4	47 89984T 5	46 96148T 1
1000 SS (E)(100 hp)(6 Cyl.)(1)	USA 2318586 - 2413843	N/A	46 96148A 8	47 89984T 4	47 89984T 5	46 96148T 1
	CAN 2320991 - 2321200					
1000 SS (E)(100 hp)(6 Cyl.)(3)	USA 2318586 - 2413843	N/A	46 96148A 8	47 89984T 4	47 89984T 5	46 96148T 1
	CAN 2320991 - 2321200					
1000 SS (E-1)(100 hp)(6 Cyl.)(1)	USA 2484633 - 2836018	N/A	46 96148A 8	47 89984T 4	47 89984T 5	46 96148T 1
	CAN 2487363 - 2836018					
1000 SS (E-1)(100 hp)(6 Cyl.)(3)	USA 2484633 - 2836018	N/A	46 96148A 8	47 89984T 4	47 89984T 5	46 96148T 1
	CAN 2487363 - 2836018					
1000 BP (100 hp)(6 Cyl.)	2399698 - 3253111	N/A	N/A	47 89984T 4	N/A	N.L.A.
100 HP(4 Cyl)(6)	USA 0B209468 and up	46 8M0113799	N/A	47 43026T 2	N/A	817275A 2
	BEL 9523034 and up					
100 HP(4 Cyl)(5)	USA 0B209468 and up	46 8M0113799	N/A	47 43026T 2	47 8M0100527	817275A 2

COOLING SYSTEM

MERCURY® OUTBOARDS

Model		Serial # Range	Complete Pump Kit	Upper Kit	Impeller	Impeller Repair Kit	Upper Housing
105 JET	BEL	9523034 and up					
	USA	0D082000 and up	N/A	46-96148A 8	47-89984T 4	47-89984T 5	46-96148T 1
	BEL	9682500 and up					
1100 (110 hp)(6 Cyl.)(1)		1870204 - 2314955	N/A	46-96148A 8	47-89984T 4	47-89984T 5	46-96148T 1
1100 (110 hp)(6 Cyl.)(3)		1870204 - 2314955	N/A	46-96148A 8	47-89984T 4	47-89984T 5	46-96148T 1
1150 (115 hp)(6 Cyl.)	USA	2836019 - 4112634	N/A	46-96148A 8	47-89984T 4	47-89984T 5	46-96148T 1
	AUS	8008665 - 8027114					
	CAN	7010763 - 7047257					
1150 (115 hp)(6 Cyl.)	USA	4112635 - 4394236	N/A	46-96148A 8	47-89984T 4	47-89984Q 5	46-96148T 1
	AUS	8027115 - 8027439					
	CAN	7047258 - 7075522					
115 HP(6 Cyl)	USA	4394237 and up	N/A	46-96148A 8	47-89984T 4	47-89984T 5	46-96148T 1
	AUS	8027440 and up					
	CAN	7075523 and up					
115 HP(4 Cyl)(6)	USA	0C100000 and up	46-8M0113799	N/A	47-43026T 2	N/A	817275A 2
	BEL	9559771 and up					
115 HP(4 Cyl)(5)	USA	0C100000 and up	46-8M0113799	N/A	47-43026T 2	47-8M0100527	817275A 2
	BEL	9559771 and up					
115 (3 Cyl) Optimax	USA	0T801000 and up	46-8M0113799	N/A	47-43026T 2	47-8M0100527	817275A 2
115 Pro XS	USA	1B751825 and up	46-8M0113799	N/A	47-43026T 2	47-8M0100527	817275A 2
1250 (125 hp)(6 Cyl.)(2)		2314956 - 2839368	N/A	46-96148A 8	47-89984T 4	47-89984T 5	46-96148T 1
1250 (125 hp)(6 Cyl.)(4)		2314956 - 2839368	N/A	46-96148A 8	47-89984T 4	47-89984T 5	46-96148T 1
1250 BP (125 hp)(6 Cyl.)		2400058 - 3253111	N/A	N.L.A.	47-89984T 4	N/A	N.L.A.
125 HP(4 Cyl)(6)	USA	0D283222 and up	46-8M0113799	N/A	47-43026T 2	N/A	817275A 2
	BEL	9793577 and up					
125 HP(4 Cyl)(5)	USA	0D283222 and up	46-8M0113799	N/A	47-43026T 2	47-8M0100527	817275A 2
	BEL	9793577 and up					
125 (3 cyl) Optimax	USA	1B736885 and up	46-8M0113799	N/A	47-43026T 2	47-8M0100527	817275A 2
1350(6 Cyl)	USA	2839369 - 3293233	N/A	46-96148A 8	47-89984T 4	47-89984T 5	46-96148T 1
1400 (140 hp)(6 Cyl.)		3293234 - 3502805	N/A	46-96148A 8	47-89984T 4	47-89984T 5	46-96148T 1
1400 (140 hp)(6 Cyl.)	USA	4865678 and up	N/A	46-96148A 8	47-89984T 4	47-89984T 5	46-96148T 1
	AUS	8052650 and up					
	CAN	7112773 and up					
1500(6 Cyl)	USA	3502806 - 4121434	N/A	46-96148A 8	47-89984T 4	47-89984T 5	46-96148T 1
	AUS	8005615 - 8028039					
	CAN	7010533 - 7048782					
1500(6 Cyl)(9)	USA	4121435 - 4865677	N/A	46-96148A 8	47-89984T 4	47-89984T 5	46-96148T 1
	AUS	8028040 - 8052649					
	CAN	7048783 - 7112772					
1500(6 Cyl)(10)	USA	4121435 - 4865677	N/A	46-96148A 8	47-89984T 4	47-89984T 5	46-96148T 1
	AUS	8028040 - 8052649					
	CAN	7048783 - 7112772					
1500 XS (6 Cyl)	USA	4868648 - 5327662	N/A	46-96148A 8	47-89984T 4	47-89984T 5	46-96148T 1
V-135 Carb	USA	0A904646 and up	N/A	46-96148A 8	47-89984T 4	47-89984T 5	46-96148T 1
V-135 DFI	USA	0G590000 and up	N/A	46-96148A 8	47-89984T 4	47-89984T 5	46-96148T 1
140 JET	USA	0D082000 and up	N/A	46-96148A 8	47-89984T 4	47-89984T 5	46-96148T 1
	BEL	9682500 and up					
V-150 Carb(8)	USA	4868998 - 0A904645	N/A	46-96148A 8	47-89984T 4	47-89984T 5	46-96148T 1
V-150 Carb(7)	USA	4868998 - 0A904645	N/A	46-96148A 8	47-89984T 4	47-89984T 5	46-96148T 1
V-150 Carb, EFI & DFI	USA	0A904646 and up	N/A	46-96148A 8	47-89984T 4	47-89984T 5	46-96148T 1
V-150XR2,4,6 - MAGNUM II,III(8)	USA	4868998 and up	N/A	46-96148A 8	47-89984T 4	47-89984T 5	46-96148T 1
V-150XR2,4,6 - MAGNUM II,III(7)	USA	4868998 and up	N/A	46-96148A 8	47-89984T 4	47-89984T 5	46-96148T 1
V-1750,V-175(8)	USA	4301235 - 6618750	N/A	46-96148A 8	47-89984T 4	47-89984T 5	46-96148T 1
	AUS	8064250 and up					

Not all parts listed are available for the European, C.I.S., Africa and Middle East Markets.
For more information, please contact your local Mercury, Mariner, MerCruiser or Quicksilver Office.

COOLING SYSTEM

MERCURY® OUTBOARDS

Model	Serial # Range	Complete Pump Kit	Upper Kit	Impeller	Impeller Repair Kit	Upper Housing
V-1750,V-175(7)	USA 4301235 - 6618750 AUS 8064250 and up	N/A	46- 96148A 8	47- 89984T 4	47- 89984T 5	46- 96148T 1
V-175 Carb, EFI & DFI	USA 6618751 and up	N/A	46- 96148A 8	47- 89984T 4	47- 89984T 5	46- 96148T 1
V-200(8)	USA 4839034 - 6625220 AUS 8061595 - 8065672	N/A	46- 96148A 8	47- 89984T 4	47- 89984T 5	46- 96148T 1
V-200(7)	USA 4839034 - 6625220 AUS 8061595 - 8065672	N/A	46- 96148A 8	47- 89984T 4	47- 89984T 5	46- 96148T 1
V-200 Carb & EFI (2.5L)	USA 6625221 and up	N/A	46- 96148A 8	47- 89984T 4	47- 89984T 5	46- 96148T 1
V-200 EFI (3.0L)	USA 0T750164 - 1B504988	817275A 5	N/A	47- 43026T 2	47- 8M0100527	817275A 2
V-200 DFI (3.0L)	USA 0G386496 - 0G589999	817275A 6	N/A	47- 43026T 2	47- 8M0100527	817275A 1
V-200 DFI (3.0L)	USA 0G590000 - 0T598999	817275A 5	N/A	47- 43026T 2	47- 8M0100527	817275A 1
V-200 DFI (3.0L)	USA 0T599000 - 1B504988	817275A 5	N/A	47- 43026T 2	47- 8M0100527	817275A 2
V-200 DFI (3.0L)	USA 1B504989 and up	817275A09	N/A	47- 43026T 2	817275A08	817275A 2
V-220 LASER	USA 0B117316 and up	N/A	46- 96148A 8	47- 89984T 4	47- 89984T 5	46- 96148T 1
V-225 (2.4L)(8)	USA 5628028 and up	N/A	46- 96148A 8	47- 89984T 4	47- 89984T 5	46- 96148T 1
V-225 (2.4L)(7)	USA 5628028 and up	N/A	46- 96148A 8	47- 89984T 4	47- 89984T 5	46- 96148T 1
V-225 (3.0L) Carb & EFI	USA 0D280813 - 0G760299	N/A	N/A	47- 43026T 2	47- 8M0100527	817275A 1
V-225 (3.0L) Carb & EFI	USA 0G760300 - 0T408999	817275A 5	N/A	47- 43026T 2	47- 8M0100527	817275A 1
V-225 (3.0L) EFI	USA 0T409000 - 1B504988	817275A 5	N/A	47- 43026T 2	47- 8M0100527	817275A 2
V-225 DFI	USA 0G590000 - 0T598999	817275A 5	N/A	47- 43026T 2	47- 8M0100527	817275A 1
V-225 DFI	USA 0T599000 - 1B504988	817275A 5	N/A	47- 43026T 2	47- 8M0100527	817275A 2
V-225 DFI	USA 1B504989 and up	817275A09	N/A	47- 43026T 2	817275A08	817275A 2
V-225 Pro XS	USA 1B104549 - 1B752546	N/A	N/A	47- 43026T 2	N/A	817275A 1
V-225 Pro XS	USA 1B752547 and up	817275A09	N/A	47- 43026T 2	817275A08	817275A 1
V-250 (3.4L)	USA 0C101891 and up	N/A	N/A	47- 85647	N.L.A.	N.L.A.
V-250 (3.0L) EFI	USA 0G129222 - 0T408999	N/A	N/A	47- 43026T 2	47- 8M0100527	817275A 1
V-250 (3.0L) EFI	USA 0T409000 - 1B504988	817275A 5	N/A	47- 43026T 2	47- 8M0100527	817275A 2
V-250 DFI	USA 1B528615 and up	817275A09	N/A	47- 43026T 2	817275A08	817275A 2
V-250 Pro XS	USA 1B426561 - 1B752546	N/A	N/A	47- 43026T 2	N/A	817275A 1
V-250 Pro XS	USA 1B752547 and up	817275A09	N/A	47- 43026T 2	817275A08	817275A 2
V-275 (3.4L)	USA 0C101891 and up	N/A	N/A	47- 85647	N.L.A.	N.L.A.
300/3.4L	USA 5611648 and up	N/A	N/A	47- 85647	N.L.A.	N.L.A.
MARK 5	574128 - 786612	N/A	N/A	47- 22748	N/A	N.L.A.
MARK 6, 6A	888005 and up	N/A	N/A	47- 22748	N/A	N.L.A.
MARK 7	557618 - 825417	N/A	N/A	N.L.A.	N/A	N.L.A.
MARK 10, 10A	1057994 - 1122327	N/A	N/A	N.L.A.	N/A	N.L.A.
MARK 15A	1200114 - 1287384	N/A	N/A	N.L.A.	N/A	N.L.A.
MARK 15	595628 and up	N/A	N/A	N.L.A.	N/A	N.L.A.
MARK 20	700000 and up	N/A	N/A	N.L.A.	N/A	N.L.A.
MARK 20H	ALL and up	N/A	N/A	N.L.A.	N/A	N.L.A.
MARK 25	1036987 and up	N/A	N/A	N.L.A.	N/A	N.L.A.
MARK 28, 28A	1158546 - 1238089	N/A	N/A	N.L.A.	N/A	N.L.A.
MARK 30, 30E	ALL and up	N/A	N/A	N.L.A.	N/A	N.L.A.
MARK 30H	997920 and up	N/A	N/A	N.L.A.	N/A	N.L.A.
MARK 40	711400 and up	N/A	N/A	N.L.A.	N/A	N.L.A.
MARK 50	ALL and up	N/A	N/A	47- 89983T	N/A	20270A 2
MARK 55	831021 and up	N/A	N/A	47- 89983T	N/A	20270A 2
MARK 55A	1227131 and up	N/A	N/A	47- 89983T	N/A	20270A 2
MARK 55H	983920 and up	N/A	N/A	N.L.A.	N/A	N.L.A.
MARK 58 (E), MARK 58A (M&E)	1139538 and up	N/A	N/A	47- 89983T	N/A	20270A 2
MARK 75	1072997 and up	N/A	N/A	N.L.A.	N/A	N.L.A.
MARK 75A	1110600 and up	N/A	N/A	N.L.A.	N/A	N.L.A.
MARK 78	1143038 and up	N/A	N/A	N.L.A.	N/A	N.L.A.
MARK 78A	1194070 and up	N/A	N/A	N.L.A.	N/A	N.L.A.

Model	Serial # Range	Complete Pump Kit	Upper Kit	Impeller	Impeller Repair Kit	Upper Housing
KF3	358136 and up	N/A	N/A	N.L.A.	N/A	N.L.A.
KE4	214324 and up	N/A	N/A	N.L.A.	N/A	N.L.A.
KG4	ALL and up	N/A	N/A	N.L.A.	N/A	N.L.A.
KF5	338136 and up	N/A	N/A	N.L.A.	N/A	N.L.A.
KE7	ALL and up	N/A	N/A	N.L.A.	N/A	N.L.A.
KF7	ALL and up	N/A	N/A	N.L.A.	N/A	N.L.A.
KG7	ALL and up	N/A	N/A	N.L.A.	N/A	N.L.A.
KH7	500022 and up	N/A	N/A	N.L.A.	N/A	N.L.A.
KF9	377150 - 379008	N/A	N/A	N.L.A.	N/A	N.L.A.
KG9	405293 - 495761	N/A	N/A	N.L.A.	N/A	N.L.A.

- (1) Models with Aluminum upper pump housings
- (2) Models with Aluminum water pumps
- (3) Models with Plastic upper pump housings
- (4) Models with Plastic water pumps
- (5) Pump screws without insulators
- (6) Pump screws with insulators
- (7) Models with driveshaft retaining nut
- (8) Models without a driveshaft retaining nut
- (9) Models with flush hole
- (10) Models without flush hole
- (11) Models having plastic upper housing use a #48752 insert cup.
- (12) Units already having a complete pump replacement using 46-46893A 6 should use the 2193818-2529894 serial group for components
- (13) Units already having a complete pump replacement using 46-46893A 6 should use USA 3795658-4126549 grouping for components
- (14) Units which have already had a complete pump replacement with the 46-46893A 6 pump should use the chart below for components

Early Mariner Impellers

Model	SN Code	Serial # Range	Impeller	Repair Kit
2A	646	ALL - ALL	47- 80395M	N.L.A.
2B (M)	6A1	008801 - 093604	47- 80395M	N.L.A.
2B (M)	6A1	131232 and up	47- 80395M	814453M
4A (M)	6E0	001011 and up	47- 96305M	N.L.A.
4A (ML)	6E0	300101 and up	47- 96305M	N.L.A.
5C (M)	6E3	102151 and up	47- 96305M	N.L.A.
5C (ML)	6E3	400101 and up	47- 96305M	N.L.A.
6C (M)	6H8	000317 and up	47- 11590M	11656T
6C (ML)	6H8	300171 and up	47- 11590M	11656T
6D (M)	6H6	001302 and up	47- 11590M	11656T
6D (ML)	6H6	300406 and up	47- 11590M	11656T
8A (M)	655	00000 - 000300	47- 95611M	N.L.A.
8A (ML)	655	00000 - 300100	47- 95611M	N.L.A.
8B (M)	677	000101 and up	47- 95611M	84181T
8B (ML)	677	300101 and up	47- 95611M	84181T
8C (M)	6G1	007990 and up	47- 11590M	11656T
8C (ML)	6G1	305951 and up	47- 11590M	11656T
8C (MUL)	6G1	700388 and up	47- 11590M	11656T
9.9C (M)	682	000551 and up	47- 84027T	46- 84277T
9.9C (ML)	682	300826 and up	47- 84027T	46- 84277T
9.9C (E)	682	250101 and up	47- 84027T	46- 84277T

Model	SN Code	Serial # Range	Impeller	Repair Kit
9.9C (EL)	682	550141 and up	47- 84027T	46- 84277T
15A (M)	651	00000 - 000285	47- 95611M	N.L.A.
15A (ML)	651	00000 - 300100	47- 95611M	N.L.A.
15C (M)	684	000101 and up	47- 84027T	46- 84277T
15C (ML)	684	300101 and up	47- 84027T	46- 84277T
15C (E)	684	250101 and up	47- 84027T	46- 84277T
15C (EL)	684	550101 and up	47- 84027T	46- 84277T
20A (M)	653	ALL - ALL	47- 95533M	N.L.A.
20A (ML)	653	ALL - ALL	47- 95533M	N.L.A.
20C (M)	6A9	000101 - 005810	47- 84797M	97793T
20C (ML)	6A9	300101 - 303730	47- 84797M	97793T
20C (E)	6A9	250101 - 250360	47- 84797M	97793T
20C (EL)	6A9	550101 - 550385	47- 84797M	97793T
20C (M)	6A9	005811 - 010111	47- 84797M	42431M
20C (ML)	6A9	303731 - 306542	47- 84797M	42431M
20C (E)	6A9	250361 - 250819	47- 84797M	42431M
20C (EL)	6A9	550386 - 550693	47- 84797M	42431M
20C (M)	6A9	010112 and up	47- 84797M	95661T
20C (ML)	6A9	306543 and up	47- 84797M	N.L.A.
20C (E)	6A9	250820 and up	47- 84797M	N.L.A.

Not all parts listed are available for the European, C.I.S., Africa and Middle East Markets.
For more information, please contact your local Mercury, Mariner, MerCruiser or Quicksilver Office.

COOLING SYSTEM

MERCURY® OUTBOARDS

Model	SN Code	Serial # Range	Impeller	Repair Kit
20C (EL)	6A9	550694 and up	47- 84797M	N.L.A.
25A (M)	648	ALL - ALL	47- 95533M	N.L.A.
25A (ML)	648	ALL - ALL	47- 95533M	N.L.A.
25A (E)	648	ALL - ALL	47- 95533M	N.L.A.
25A (EL)	648	ALL - ALL	47- 95533M	N.L.A.
25C (M)	695	00000 - 014870	47- 84797M	97793T
25C (ML)	695	00000 - 312185	47- 84797M	97793T
25C (E)	695	00000 - 252290	47- 84797M	97793T
25C (EL)	695	00000 - 553575	47- 84797M	97793T
25C (M)	695	014871 - 023895	47- 84797M	42431M
25C (ML)	695	312186 - 318173	47- 84797M	42431M
25C (E)	695	252291 - 253861	47- 84797M	42431M
25C (EL)	695	553576 - 555959	47- 84797M	42431M
25C (M)	695	023896 and up	47- 84797M	95661T
25C (ML)	695	318174 and up	47- 84797M	95661T
25C (E)	695	253862 and up	47- 84797M	95661T
25C (EL)	695	555960 and up	47- 84797M	95661T
28 (M)	664	ALL - ALL	47- 84797M	N.L.A.
28 (ML)	664	ALL - ALL	47- 84797M	N.L.A.
28 (E)	664	ALL - ALL	47- 84797M	N.L.A.
28 (EL)	664	ALL - ALL	47- 84797M	N.L.A.
30A (M)	689	000366 - 014805	47- 84797M	97793T
30A (ML)	689	301911 - 315315	47- 84797M	97793T
30A (E)	689	100251 - 103275	47- 84797M	97793T
30A (EL)	689	401216 - 407815	47- 84797M	97793T
30A (M)	689	014806 - 022058	47- 84797M	42431M
30A (ML)	689	315316 - 321376	47- 84797M	42431M
30A (E)	689	103276 - 105324	47- 84797M	42431M
30A (EL)	689	407816 - 411946	47- 84797M	42431M
30A (M)	689	022059 and up	47- 84797M	95661T
30A (ML)	689	321377 and up	47- 84797M	95661T
30A (E)	689	105325 and up	47- 84797M	95661T
30A (EL)	689	411947 and up	47- 84797M	95661T
40A (M)	676	A00346 and up	47- 99971M	N.L.A.
40A (ML)	676	A41356 and up	47- 99971M	N.L.A.
40A (E)	676	A10121 and up	47- 99971M	N.L.A.
40A (EL)	676	A50631 and up	47- 99971M	N.L.A.
40B (M)	676	B000106 and up	47- 99971M	84363T
40B (ML)	676	B300101 and up	47- 99971M	84363T
40B (E)	676	B100461 and up	47- 99971M	84363T

Model	SN Code	Serial # Range	Impeller	Repair Kit
40B (EL)	676	B400420 and up	47- 99971M	84363T
40C (M)	6E9	000106 and up	47- 99971M	84363T
40C (ML)	6E9	300126 and up	47- 99971M	84363T
40C (E)	6E9	100101 and up	47- 99971M	84363T
40C (EL)	6E9	400231 and up	47- 99971M	84363T
48 (M)	670	00000 - 02415	47- 81423M	N.L.A.
48 (ML)	670	00000 - 33125	47- 81423M	N.L.A.
48 (M)	670	02416 - 02640	47- 97108M	N.L.A.
48 (ML)	670	33126 - 34580	47- 97108M	N.L.A.
48 (M)	670	02641 and up	47- 97108M	N.L.A.
48 (ML)	670	34581 and up	47- 97108M	N.L.A.
W-48 (M)	670	002161 and up	47- 97108M	N.L.A.
W-48 (ML)	670	311996 and up	47- 97108M	N.L.A.
55 (M)	663	00000 - 02730	47- 81423M	N.L.A.
55 (ML)	663	00000 - 34925	47- 81423M	N.L.A.
55 (M)	663	02731 and up	47- 97108M	N.L.A.
55 (ML)	663	34926 and up	47- 97108M	N.L.A.
55 (E)	663	004041 and up	47- 97108M	84188T
55 (EL)	663	315379 and up	47- 97108M	84188T
W55 (ML)	663	578278 and up	47- 97108M	84188T
60 (E)	675	00101 and up	47- 97108M	84188T
60 (EL)	675	30101 and up	47- 97108M	84188T
60 (E)	6F0	000101 and up	47- 97108M	84188T
60 (EL)	6F0	300311 and up	47- 97108M	84188T

OUTBOARD THERMOSTATS & TEMPERATURE SENDER

WATER TEMPERATURE SENDER



13536A13

A two wire temperature sender for use on V-6 outboard product. Furnished standard on engine powerhead, the fiche card specific to the application should be used to verify correct use.

WATER TEMPERATURE SENDER



13536A14

A four wire temperature sender for use on V-6 outboard product. Furnished standard on engine powerhead, the fiche card specific to the application should be used to verify correct use.

WATER TEMPERATURE SENDER

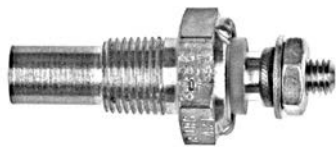

12415

(1/8"-27 NPT threads)
Fits outboard applications.

TEMPERATURE SENDER KIT



12415A 2

Allows adding a temperature sender to outboards equipped with a factory built coastal flush. Includes a temperature sender, fittings, cable ties and instruction sheet. This kit provides for the use of a coastal flush and a temperature sender at the same time.

Fits Mercury/Mariner 75-125 hp. (1993 and newer) 2 cycle outboards. Primarily designed for adding to a Saltwater model which comes with the coastal flush as standard equipment.

THERMOSTAT



14586

120 Degrees

THERMOSTAT



8M0117413

120 Degrees
40-60HP and 40/60HP SeaPro EFI FourStrokes (1C453840 and above).

THERMOSTAT



75692

143 Deg.

THERMOSTAT - 110



850055001

THERMOSTAT - 110

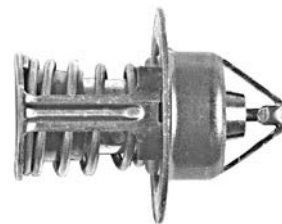

F528068

COOLING SYSTEM

MERCURY® OUTBOARDS

THERMOSTAT

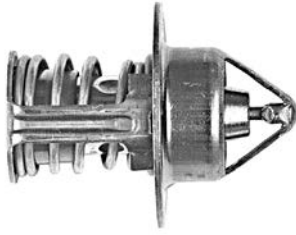

F664068

130 Deg.

THERMOSTAT

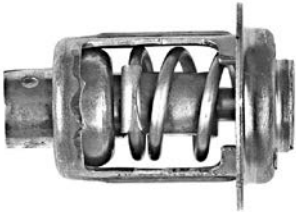

895338

130 Deg.

THERMOSTAT



8M0139434

125 Degrees

15/20 EFI FourStroke outboard, 0R833820 and above.

Quicksilver Branded

REWIND STARTER

STARTER ROPE AND RECOIL SPRING CHARTS

Mercury/Mariner Recoil Springs and Ropes

Model	Serial # Range	Manual Starter Recoil Spring	Manual Starter Replacement Rope
2.5 FourStroke	JPN 0R131842 and up	N.L.A.	50-850057K01
3.5 FourStroke	JPN 0R131842 and up	N.L.A.	50-850057K01
4 (40)(1 Cyl)	USA 2498136 - 4107219	N.L.A.	50-12066K10
	AUS 3306257 - 8026539		
	BEL 9000306 - 9072178		
	CAN 3305152 - 7045757		
4 (4, 40)(Gnat)	BEL 9075839 - 9256980	N.L.A.	50-90892A 2
	CAN 7085673 - 7146487	N.L.A.	50-90892A 2
4 (40)(2 Cyl)	USA 5589202 and up	N.L.A.	50-90892A 2
	AUS 8065265 and up		
	BEL 9256981 and up		
	CAN 7146488 and up		
4 (1 Cyl)	USA 5595532 - 0A809600	N.L.A.	50-12066K10
	AUS 8068065 and up		
	BEL 9258281 - 9477829		
	CAN 7143688 and up		
4 (1 Cyl)	USA 0A809601 - 0A834680	24-812645T	N.L.A.
	BEL 9477830 - 9542670		
4 (1 Cyl)	USA 0A834681 and up	24-812645T	8M0110704
	BEL 9542671 and up		
4 FourStroke	JPN 0R000001 - 0R051739	24-812645T	8M0110704
4 FourStroke	JPN 0R051740 and up	24-812645T10	8M0110704
4.5 (4.5, 45)(1 Cyl)	USA 4107220 and up	N.L.A.	50-12066K10
	AUS 8026540 and up		
	BEL 9072179 and up		
	CAN 7045758 and up		
5 (1 Cyl)	USA 0A809601 - 0A834680	24-812645T	N.L.A.
	BEL 9477830 - 9542670		
5 (1 Cyl)	USA 0A834681 and up	24-812645T	8M0110704
BEL 9542671 and up			
5 FourStroke	JPN 0R000001 - 0R051739	24-812645T	8M0110704
5 FourStroke	JPN 0R051740 and up	24-812645T10	8M0110704
6 (60, 60J)	1408611 - 2387383	N.L.A.	50-12066K10
6	USA 0A197112 - 0D280999	N.L.A.(1)	50-850057K01
	BEL 9461526 - 9792199	N.L.A.(1)	50-850057K01
6	USA 0A197112 - 0D280999	24-86857T01(2)	50-850057K01
	BEL 9461526 - 9792199	24-86857T01(2)	50-850057K01
6	USA 0D281000 - 0T800749	24-86857T01	50-850057K01
	BEL 9792200 and up	24-86857T01	50-850057K01
6 FourStroke	JPN 0R000001 - 0R051739	24-812645T	8M0110704
6 FourStroke	JPN 0R051740 and up	24-812645T10	8M0110704
7.5 (7.5, 75)	USA 2529895 and up	N.L.A.	50-12066K10
	AUS 8015315 and up	N.L.A.	50-12066K10
	BEL 9043194 and up	N.L.A.	50-12066K10
	CAN 7028598 and up	N.L.A.	50-12066K10
8	USA 0A197112 - 0D280999	N.L.A.(1)	50-850057K01
	BEL 9461526 - 9792199	N.L.A.(1)	50-850057K01

Model	Serial # Range	Manual Starter Recoil Spring	Manual Starter Replacement Rope
8	USA 0A197112 - 0D280999	24-86857T01(2)	50-850057K01
	BEL 9461526 - 9792199	24-86857T01(2)	50-850057K01
8	USA 0D281000 and up	24-86857T01	50-850057K01
	BEL 9792200 and up	24-86857T01	50-850057K01
8 FourStroke(232 cc)	USA 0H000058 - 0H017349	N.L.A.	50-12066K10
8 FourStroke(232 cc)	USA 0G760300 and up	N.L.A.	50-12066K10
8 FourStroke(323cc)	BEL 0P086824 - 0P325499	24-852778	50-12066K10
8 FourStroke(209 cc)	JPN 0R042475 and up	24-804024T07	8M0110704
	BEL 0P325500 and up	24-804024T07	8M0110704
9.8 (110)	1470349 - 3795657	N.L.A.	50-12066K10
9.8 (9.8, 110)	USA 3795658 and up	N.L.A.	50-12066K10
	AUS 8015040 and up	N.L.A.	50-12066K10
	BEL 9041439 and up	N.L.A.	50-12066K10
	CAN 7027323 and up	N.L.A.	50-12066K10
9.9	USA 0A197112 - 0D280999	N.L.A.(1)	50-850057K01
	BEL 9461526 - 9792199	N.L.A.(1)	50-850057K01
9.9	USA 0A197112 - 0D280999	24-86857T01(2)	50-850057K01
	BEL 9461526 - 9792199	24-86857T01(2)	50-850057K01
9.9	USA 0D281000 and up	24-86857T01	50-850057K01
	BEL 9792200 and up	24-86857T01	50-850057K01
9.9 FourStroke(232cc)	USA 0H000058 - 0H016909	N.L.A.	50-12066K10
9.9 FourStroke(323cc)	USA 0G760300 - 0T979999	24-852778	50-12066K10
	BEL 0P075166 - 0P325499	24-852778	50-12066K10
9.9 FourStroke(209 cc)	JPN 0R042475 and up	24-804024T07	8M0110704
	BEL 0P325500 and up	24-804024T07	8M0110704
10 (100)	1290910 - 1455239	N.L.A.	50-12066K10
10 (Mark 10, 10A)	1057994 - 1122327	N.L.A.	50-12066K10
10 (XR10, Sea Pro 10)	USA 0D038000 - 0D280999	N.L.A.(1)	50-850057K01
	BEL 9596000 - 9792199	N.L.A.(1)	50-850057K01
10 (XR10, Sea Pro 10)	USA 0D038000 - 0D280999	24-86857T01(2)	50-850057K01
	BEL 9596000 - 9792199	24-86857T01(2)	50-850057K01
10 (XR10, Sea Pro 10)	USA 0D281000 and up	24-86857T01	50-850057K01
	BEL 9792200 and up	24-86857T01	50-850057K01
15 (Mark 15)	595628 and up	N.L.A.	50-12066K10
15 (Mark 15A)	1200114 - 1287384	N.L.A.	50-12066K10
15	1288910 - 1349697	N.L.A.	50-12066K10
15	USA 0B292414 - 0D280999	N.L.A.(1)	50-850057K01
	BEL 9542620 - 9792199	N.L.A.(1)	50-850057K01
15	USA 0B292414 - 0D280999	24-86857T01(2)	50-850057K01
	BEL 9542620 - 9792199	24-86857T01(2)	50-850057K01
15	USA 0D281000 and up	24-86857T01	50-850057K01
	BEL 9792200 and up	24-86857T01	50-850057K01
15 FourStroke, 323cc	USA 0G590000 - 1B727495	24-852778	50-12066K10
	BEL 9973100 and up	24-852778	50-12066K10
15 Carb & EFI FourStroke	JPN 0R235949 and up	24-804024008	50-8M0110715
16 (Mark 20)	700000 and up	N.L.A.	50-12066K10

Not all parts listed are available for the European, C.I.S., Africa and Middle East Markets.
 For more information, please contact your local Mercury, Mariner, MerCruiser or Quicksilver Office.

REWIND STARTER

MERCURY® OUTBOARDS

Model	Serial # Range	Manual Starter Recoil Spring	Manual Starter Replacement Rope
18 (18, 18XD)	USA 5837437 and up	24- 86857T01	50- 12066K10
	AUS 8071973 and up	24- 86857T01	50- 12066K10
	BEL 9308306 and up	24- 86857T01	50- 12066K10
	CAN 7173723 and up	24- 86857T01	50- 12066K10
20 (200)	1292910 - 3537530	N.L.A.	50- 12066K10
20 (20, 200)	USA 3537531 - 6443972	N.L.A.	50- 12066K10
	AUS 8006265 and up	N.L.A.	50- 12066K10
	BEL 9016254 - 9415100	N.L.A.	50- 12066K10
	CAN 7012358 - 7209532	N.L.A.	50- 12066K10
20 (20, 20XD)	USA 6443973 - 0T800999	24- 86857T01	50- 12066K10
	BEL 9415101 and up	24- 86857T01	50- 12066K10
	CAN 7209533 and up	24- 86857T01	50- 12066K10
20 Carb & EFI FourStroke	JPN 0R235168 and up	24-804024008	50-8M0110715
22 (Mark 28)	1158546 - 1238089	N.L.A.	50- 12066K10
25 (250)	1467499 - 1499331	N.L.A.	50- 12066K10
25 (25, 25XD)	USA 5705532 and up	24- 86857T01	50- 12066K10
	AUS 8073158 and up	24- 86857T01	50- 12066K10
	BEL 9315316 and up	24- 86857T01	50- 12066K10
	CAN 7166928 and up	24- 86857T01	50- 12066K10
25 (3 Cyl)(Lightning)	BEL 0E268781 - 0E287999	N.L.A.	50- 12066T03
	USA 0E288000 and up	N.L.A.	50- 12066T03
25 FourStroke(Carb)	USA 0G590000 - 1B344298	24- 86857T01	50- 12066K10
	BEL 9973100 - 0P388282	24- 86857T01	50- 12066K10
25 FourStroke(EFI)	JPN 0R106999 and up	24-804024008	50-8M0110715
30 (300)	1271885 - 1356947	N.L.A.	50- 12066K10
30 (2 Cyl)(644cc)	USA 0G053314 and up	24- 86857T01	50- 12066K10
	BEL 9854537 and up	24- 86857T01	50- 12066K10
30 FourStroke	USA 0G760300 - 1B226999	24- 86857T01	50- 12066K10
	BEL 0P017000 - 0P400999	24- 86857T01	50- 12066K10
30 FourStroke(EFI)	JPN 0R106999 and up	24-804024008	50-8M0110715
35 (350)	1217222 - 1960826	N.L.A.	50- 12066K10
35 (350)	1960827 - 2874703	N.L.A.	50- 12066K10
35 (2 Cyl)	USA 6445653 and up	N.L.A.	50- 12066K10
	BEL 9384476 and up	N.L.A.	50- 12066K10
	CAN 7209608 and up	N.L.A.	50- 12066K10
40 (Mark 55)	831021 and up	N.L.A.	50- 12066K10
40 (400)	1279685 - 1476509	N.L.A.	50- 12066K10
40 (400)(2 Cyl)	2874704 - 3336257	N.L.A.	50- 12066K10
40 (40, 402) Through 1983	USA 3336258 and up	N.L.A.	50- 12066K10
	AUS 8002335 and up	N.L.A.	50- 12066K10
	BEL 3339688 and up	N.L.A.	50- 12066K10
	CAN 3340783 and up	N.L.A.	50- 12066K10
40 (644cc)(2 Cyl)	USA 0G053314 and up	24- 86857T01	50- 12066K10
	BEL 9854537 and up	24- 86857T01	50- 12066K10
40 (4 Cyl)	USA 0C159200 and up	N.L.A.	50- 12066K10
	BEL 9570790 and up	N.L.A.	50- 12066K10
40 (3 Cyl)	USA 0G531301 and up	24- 86857T01	50- 12066K10
	BEL 9973100 and up	24- 86857T01	50- 12066K10
40 FourStroke(3 cyl)	USA 0T409000 - 1B344306	24- 86857T01	50- 12066K10
	BEL 0P153500 and up		
	CHN 1C000001 and up		

Model	Serial # Range	Manual Starter Recoil Spring	Manual Starter Replacement Rope
40 FourStroke(4-Cyl)	USA 0G760300 - 0T408999	24- 86857T01	50- 12066K10
	BEL 0P153499 - 0P153499	24- 86857T01	50- 12066K10
45 (Mark 58)	1139538 and up	N.L.A.	50- 12066K10
45 (4 Cyl)	USA 5531630 and up	N.L.A.	50- 12066K10
	AUS 8063985 and up	N.L.A.	50- 12066K10
	BEL 9248006 and up	N.L.A.	50- 12066K10
	CAN 7143688 and up	N.L.A.	50- 12066K10
50 (500)	1421113 - 1755548	N.L.A.	50- 12066K10
50 (500)	USA 1770179 - 2116317	N.L.A.	50- 12066K10
	CAN 1755549 - 2097444	N.L.A.	50- 12066K10
50 (4 Cyl)(50, 500)	USA 2116318 and up	N.L.A.	50- 12066K10
	AUS 2863739 and up	N.L.A.	50- 12066K10
	BEL 9001581 and up	N.L.A.	50- 12066K10
	CAN 2097445 and up	N.L.A.	50- 12066K10
60 (Mark 75)	1072997 and up	N.L.A.	50- 12066K10
60 (600)(6 Cyl)	1303411 - 1542744	N.L.A.	50- 12066K10
65 (650)(4 Cyl)	1542745 - 1765043	N.L.A.	50- 12066K10
70 (Mark 78)	1143038 and up	N.L.A.	50- 12066K10
70 (700)(6 Cyl)	1296411 - 1566239	N.L.A.	50- 12066K10

(1) Flywheel attached with stub shaft.

(2) Flywheel attached with nut.

Early Mariner Recoil Springs & Ropes

Model	SN Code	Manual Starter Recoil Spring	Manual Starter Replacement Rope
	642	24- 80056M	50- 12066Q10
4A	6EO	24- 95484M	50- 12066Q10
5A	661	24- 80056M	50- 12066Q10
5C	6E3	24- 95484M	50- 12066Q10
6C	6H8	24- 95484M	50- 12066Q10
6D	6H6	24- 95484M	50- 12066Q10
8A	655	N.L.A.	50- 12066Q10
8B	677	N.L.A.	50- 12066Q10
8C	6G1	24- 95484M	50- 12066Q10
9.9C	682	N.L.A.	50- 12066Q10
15A	651	N.L.A.	50- 12066Q10
15C	684	N.L.A.	50- 12066Q10
20A	653	N.L.A.	50- 12066Q10
20C	6A9	24- 83588M	50- 12066Q10
25A	648	N.L.A.	50- 12066Q10
25C	695	24- 83588M	50- 12066Q10
28	664	N.L.A.	50- 12066Q10
30A	689	24- 83588M	50- 12066Q10
40	676	24- 83588M	50- 12066Q10
48	670	N.L.A.	50- 12066Q10
W-48	670	N.L.A.	50- 12066Q10
W-55	663	N.L.A.	50- 12066Q10

POWERHEAD COMPONENTS

HOSE CLAMP KIT

HOSE CLAMP KIT



91-803146A04

Various clamps and the crimping tool in a convenient plastic tray container. Kit is originally furnished with 15 each of the 12.8mm, 14.0mm, 15.3mm, 16.2mm clamps and 5 each of the 25.6mm and 28.6mm diameter stainless steel clamps. Aids in the installation of high pressure hose clamps.

CRIMPING TOOL



91-803146T

Used to clamp high pressure hose clamps. Part of clamp tool kit (P/N 803146A04)

HOSE CLAMP



54-888441

12.8 mm diameter stainless steel stepless ear clamp.

54-850241

14.0 mm diameter stainless steel stepless ear clamp.

54-856880

15.3 mm diameter stainless steel stepless ear clamp.

54-13791

15.7 mm diameter stainless steel stepless ear clamp.

54-855697

16.2 mm diameter stainless steel stepless ear clamp.

54-855228

25.6 mm diameter stainless steel stepless ear clamp.

HOSE CLAMP



54-888988019

22.6 mm diameter stainless steel stepless ear clamp.

Used on the new low permeation primer bulbs to provide a tight seal between the bulb and the valve.

HOSE CLAMP



54-850896

28.6 mm diameter stainless steel stepless ear clamp.

GASKET SETS - MERCURY/MARINER POWERHEAD

GASKET SET

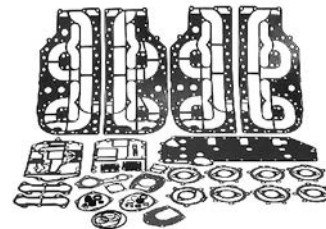

27-13461A99

GASKET SET

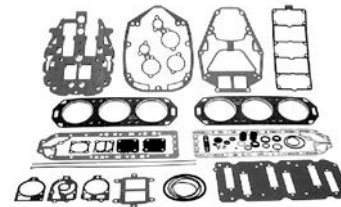

27-14697A87

POWERHEAD COMPONENTS

MERCURY® OUTBOARDS

GASKET SET



16115A03

GASKET SET

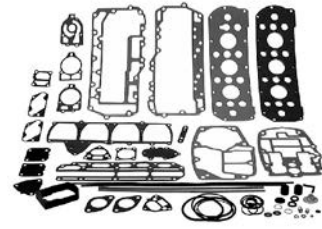

27-73645A87

GASKET SET

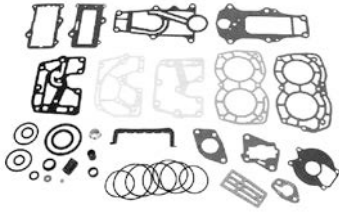

27-41499A88

GASKET SET



27-78028A78

GASKET SET

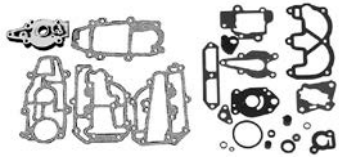

27-42364A92

GASKET SET

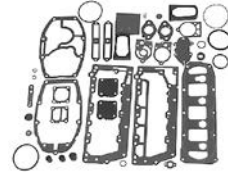

27-85491A90

GASKET SET

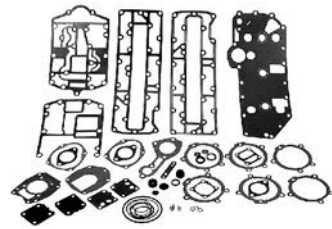

27-43004A99

GASKET SET

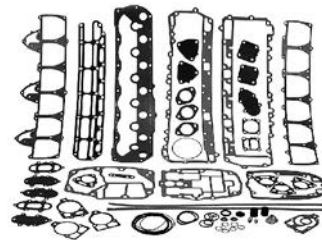

27-85653A87

GASKET SET

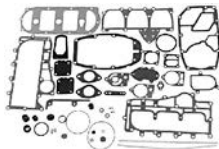

27-43779A87

GASKET SET

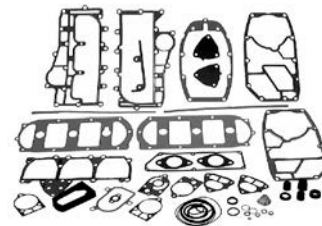

27-88449A32

GASKET SET

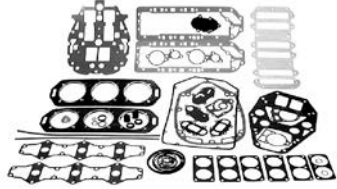

27- 89221A80

GASKET SET



27- 89221A88

GASKET SET

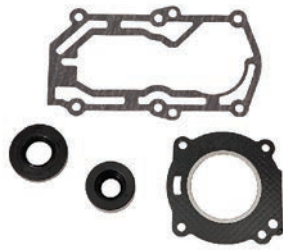

27- 898101928

GASKET SET

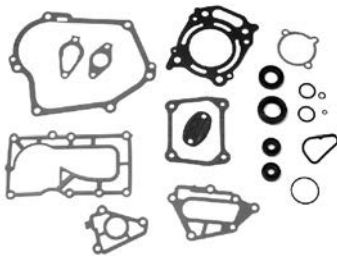

27- 803508A05

Fits the 4/5/6 hp. FourStroke outboards s/n 0R057260-0R067089.

GASKET SET



27- 8M0114820

Fits the 4/5/6 hp. FourStroke outboards s/n 0R057259 & prior.

GASKET SET



27- 803663A08

Fits the 20 hp. FourStroke outboard beginning with serial number 0R235168.

GASKET SET

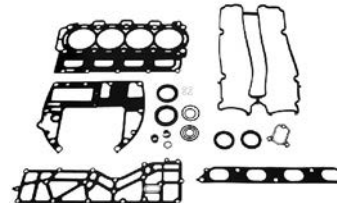

27- 804345A02

GASKET SET

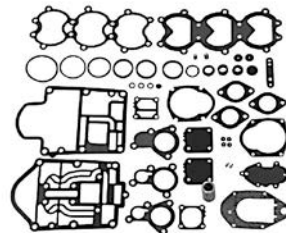

27- 812867A97

POWERHEAD COMPONENTS

MERCURY® OUTBOARDS

GASKET SET

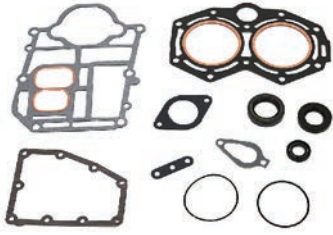

27-8M0084273

GASKET SET

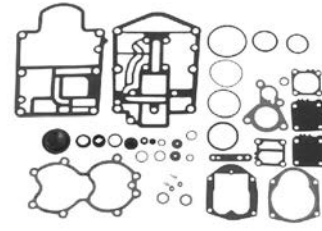

27-822420A94

GASKET SET

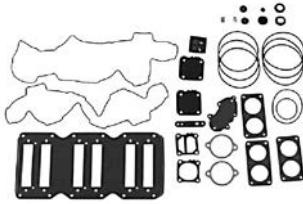

27-814195A93

GASKET SET

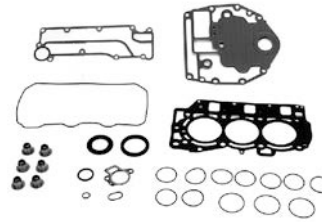

27-825231A02

GASKET SET

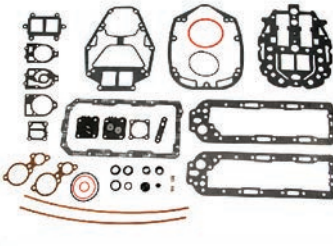

27-815076A04

GASKET SET

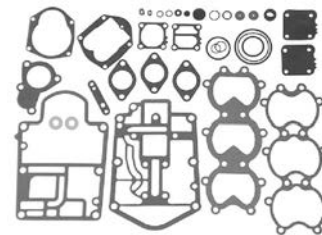

27-828553A97

GASKET SET



27-815791A92

Complete powerhead gasket set. Cylinder head gaskets are not included and need to be purchased separately.

GASKET SET

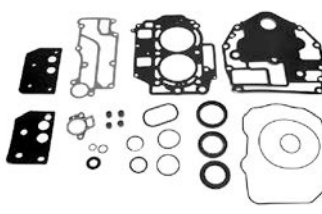

27-830270A02

GASKET SET

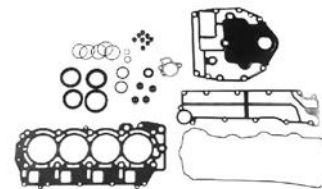

27-832013A96

GASKET SET

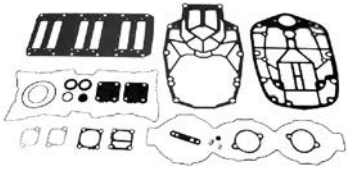

27-832934A00

GASKET SET

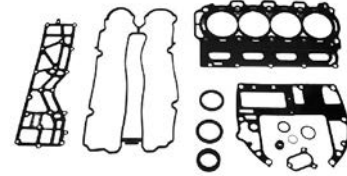

27-858732A03

GASKET SET

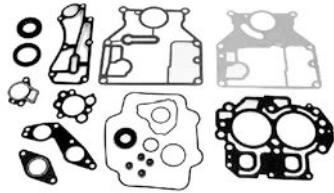

27-835427A00

GASKET SET

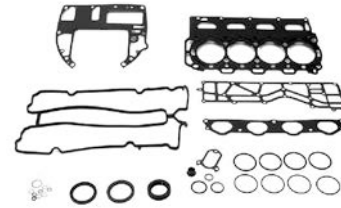

27-858732T02

GASKET SET

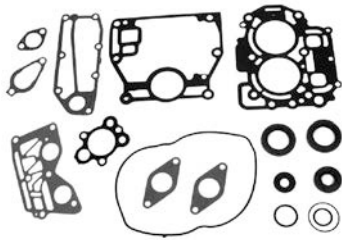

27-835427A04

Fits the 8/9.9 hp. FourStroke outboard, beginning with Model Year 2005.

GASKET SET

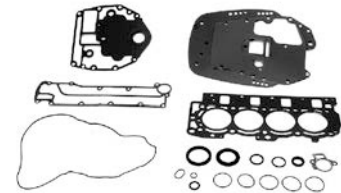

27-859352A01

GASKET SET

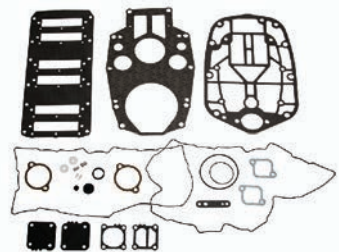

27-841220A03

Powerhead gasket set.

Fits the 250 ProXS outboard (1B246561 and above), 250XS outboard (1T651945 abd above), and the 300XS outboard (1E001867 and above).

GASKET SET

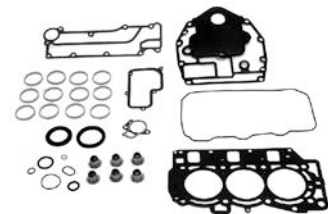

27-859352A02

POWERHEAD COMPONENTS

GASKET SET

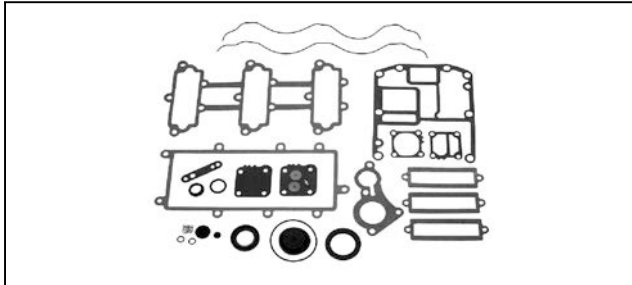

27-879855A04

Fits the Mercury/Mariner 75/90/115 hp. (3 cylinder) 1.5L OptiMax outboard.

GASKET SET

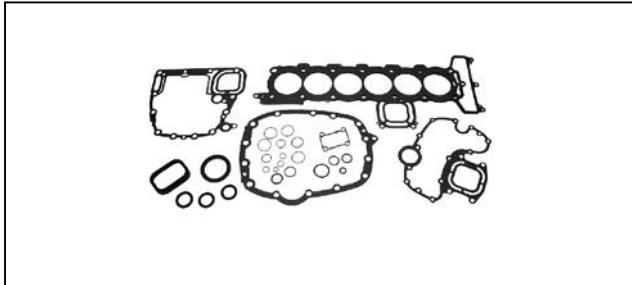

27-880552A07

The head gasket is included in this kit.
Fits the 200-300 hp. FourStroke (6 cylinder) Verado outboard.

GASKET SET

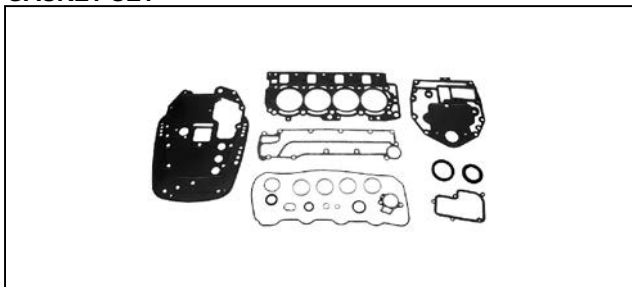

27-883599A02

Fits the 40/50/60 EFI FourStroke outboards, beginning with serial number 0T40900 & above.

GASKET SET

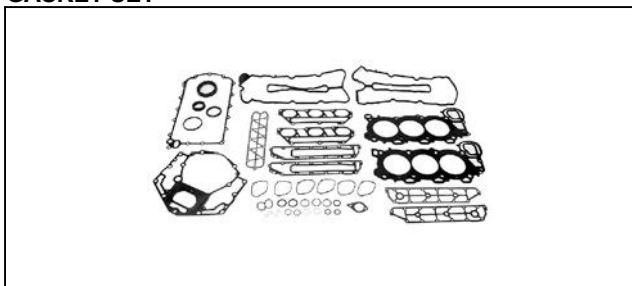

27-887810A04

GASKET SET

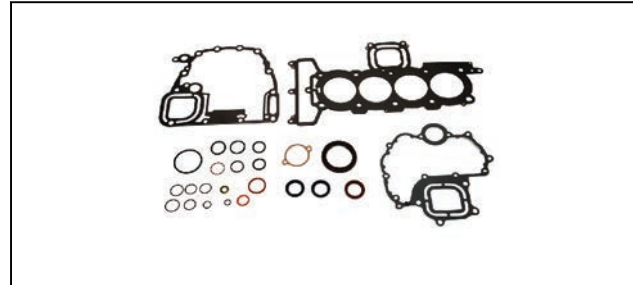

27-896142A07

Head gasket is included in this kit.
Fits the FourStroke 4-cylinder Verado outboard.

GASKET SET



27-897534A07

Fits the 75/90/115 hp. EFI FourStroke outboard, serial number 1B366823-2B094995.

GASKET SET

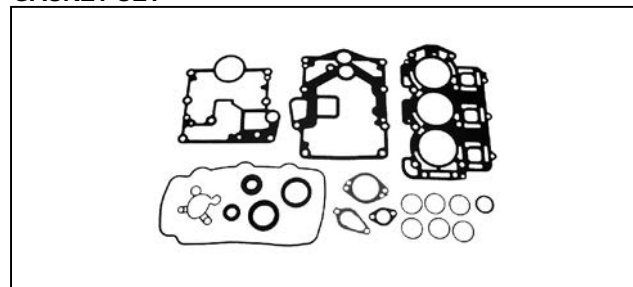

27-8M0079064

GASKET SET

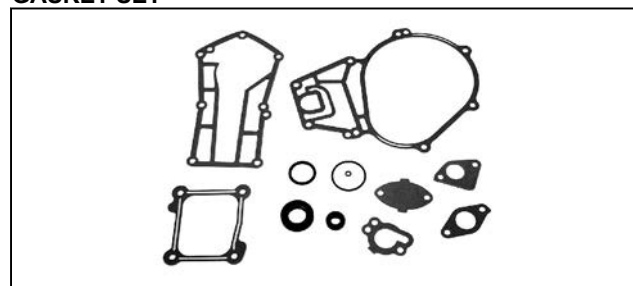

27-898103A67

Fits the 2.5/3.5 hp. FourStroke outboard, serial number 0R131842 & above.

GASKET SET

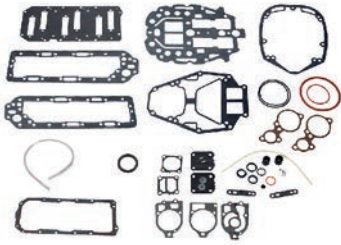

27-8M0046714

Complete gasket set. Cylinder head gaskets are not included and need to be purchased separately.

GASKET SET

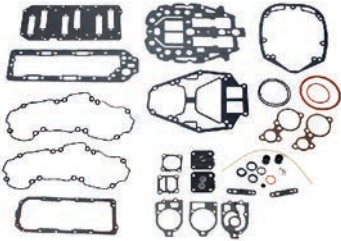

27-8M0046715

GASKET SET

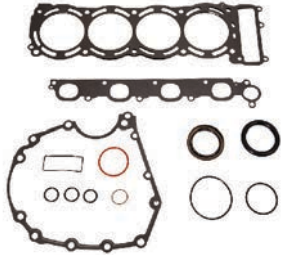

27-8M0057763

Contains the strainer seal, "o" rings, exhaust gasket, adapter plate gasket, cylinder head gasket and top main bearing seal.
Fits the F150 Hp. EFI FourStroke outboard, serial number 1B905505 and above.

GASKET SET

Image not Available.

27-8M0134438

15/20 EFI FourStroke outboard, 0R833820 and above.
Quicksilver Branded

HEAD SEALING O-RINGS

HEAD O-RING

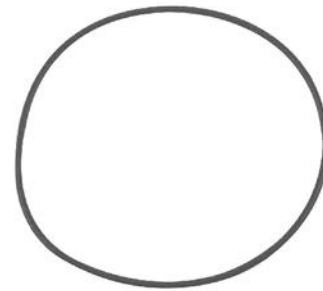

25-818573

HEAD O-RING

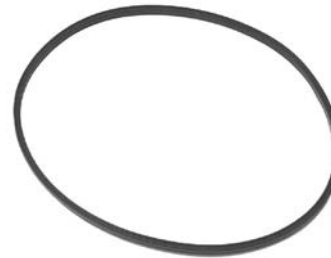

859772 1

HEAD O-RING

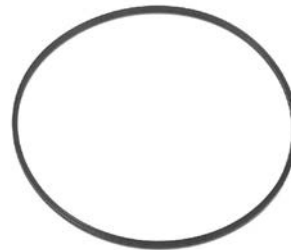

878453

HEAD SEAL



818574

POWERHEAD COMPONENTS

MERCURY® OUTBOARDS

HEAD SEAL

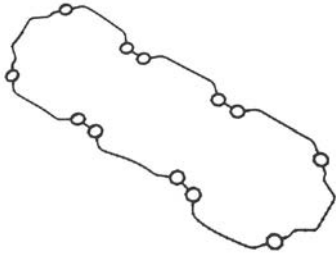

858452 1

HEAD GASKETS

HEAD GASKET

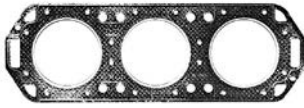

27- 18785T

HEAD GASKET

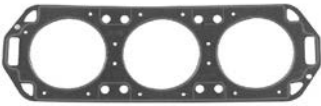

27- 18786T

HEAD GASKET



27- 41244T02

HEAD GASKET



27- 41247T01

HEAD GASKET

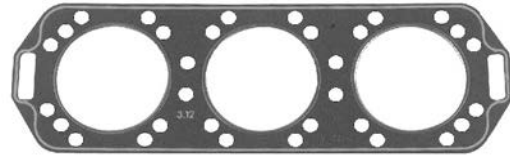

27- 79583 1

HEAD GASKET



27- 96281T01

HEAD GASKET



27- 812939T25

Fits the 20 hp. FourStroke outboard beginning with serial number 0R235168.

HEAD GASKET



27- 803508 2

GASKET



27-804115 1

HEAD GASKET



27-822844T05

HEAD GASKET

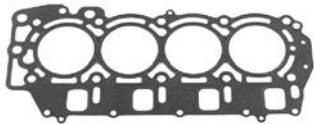

27-825032

HEAD GASKET

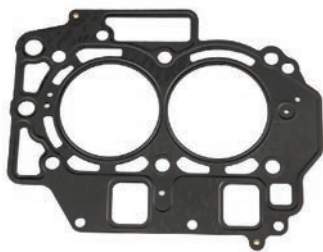

27-8M0049885

HEAD GASKET



27-8M0052705

HEAD GASKET

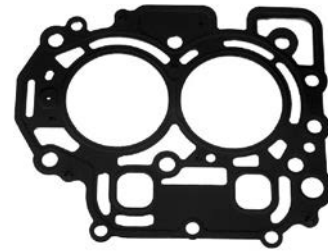

27-850836001

Fits the 8/9.9 hp. FourStroke outboard, beginning with Model Year 2005.

HEAD GASKET



27-8M0118179

40/50/60 Horsepower 0P094500 Thru 1C453839

HEAD GASKET



27-887848002

Starboard side cylinder head gasket.

HEAD GASKET



27-887848003

Port side cylinder head gasket.

POWERHEAD COMPONENTS

HEAD GASKET



27-8M0033476

HEAD GASKET



27-8M0024565

HEAD GASKET

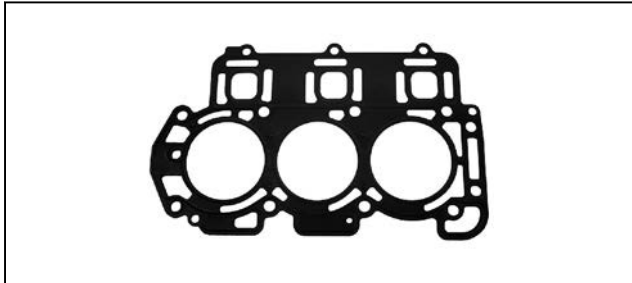

27-898101T41

HEAD GASKET

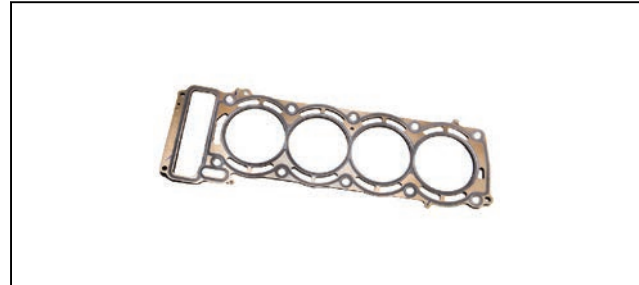

27-8M0090776

Cylinder head gasket.
Fits the F75-115 (2.1L) FourStroke outboard (s/n USA 2B094996 and above).

HEAD GASKET



Image not Available.

27-8M0134437

15/20 EFI FourStroke outboard, 0R833820 and above.

GASKET SET APPLICATION CHARTS - POWERHEAD

Mercury/Mariner Powerhead Gasket Sets

Model	Serial # Range	Gasket Set	Head O-Rings	Head Gaskets	Head Seals
2.5 FourStroke	JPN 0R131842 and up	27-898103A67	N/A	N/A	N/A
3.5 FourStroke	JPN 0R131842 and up	27-898103A67	N/A	N/A	N/A
2.5	0A855097 - 0G710612	27-898101928	N/A	N/A	N/A
3	0A855097 and up	27-898101928	N/A	N/A	N/A
3.3 NON-SHIFT	0D901217 and up	27-898101928	N/A	N/A	N/A
3.3 SHIFT	0D901217 and up	27-815076A04	N/A	N/A	N/A
3.5 (water cooled)	USA 6202173 and up	N.L.A.	N/A	N/A	N/A
3.6 (water cooled)	USA 5404657 and up	N.L.A.	N/A	N/A	N/A
3.6 (water cooled)	BEL 9252831 and up	N.L.A.	N/A	N/A	N/A
3.6 (water cooled)	CAN 7145388 and up	N.L.A.	N/A	N/A	N/A
3.9 (39)	USA 1655013 - 2095745	N.L.A.	N/A	N/A	N/A
3.9 (39)	USA 2098037 - 2498135	N.L.A.	N/A	N/A	N/A
4 (1 cyl.)	USA 2498136 - 0A809600	N.L.A.	N/A	N/A	N/A
4 (1 cyl.)	AUS 3306257 and up	N.L.A.	N/A	N/A	N/A

POWERHEAD COMPONENTS

MERCURY® OUTBOARDS

Model	Serial # Range	Gasket Set	Head O-Rings	Head Gaskets	Head Seals
4 (1 cyl.)	BEL 9000306 - 9477829	N.L.A.	N/A	N/A	N/A
4 (1 cyl.)	CAN 3305152 and up	N.L.A.	N/A	N/A	N/A
4 (1 cyl.)	USA 0A809601 - 0A855096	N.L.A.	N/A	N/A	N/A
4 (1 cyl.)	BEL 9477830 - 9589153	N.L.A.	N/A	N/A	N/A
4 (1 cyl.)	USA 0A855097 - 0G710612	16115A03	N/A	N/A	N/A
4 (1 cyl.)	BEL 9589154 - 0P016999	16115A03	N/A	N/A	N/A
4 (2 cyl.)	ALL and up	N.L.A.	N/A	N/A	N/A
4 FourStroke	JPN 0R000001 - 0R057259	27-8M0114820	N/A	27-803508	N/A
4 FourStroke	JPN 0R057260 - 0R067089	27-803508A05	N/A	27-803508	N/A
4 FourStroke	JPN 0R067090 and up	NLA	N/A	27-803508 2	N/A
4.5 (1 cyl.)	USA 2498136 - 0A809600	N.L.A.	N/A	N/A	N/A
4.5 (1 cyl.)	AUS 3306257 and up	N.L.A.	N/A	N/A	N/A
4.5 (1 cyl.)	BEL 9000306 - 9477829	N.L.A.	N/A	N/A	N/A
4.5 (1 cyl.)	CAN 3305152 and up	N.L.A.	N/A	N/A	N/A
5 (1 cyl.)	USA 0A809601 - 0A855096	N.L.A.	N/A	N/A	N/A
5 (1 cyl.)	BEL 9477830 - 9589153	N.L.A.	N/A	N/A	N/A
5 (1 cyl.)	USA 0A855097 - 0G710612	16115A03	N/A	N/A	N/A
5 (1 cyl.)	BEL 9589154 - 0P016999	16115A03	N/A	N/A	N/A
5 FourStroke	JPN 0R000001 - 0R057259	27-8M0114820	N/A	27-803508	N/A
5 FourStroke	JPN 0R057260 - 0R067089	27-803508A05	N/A	27-803508	N/A
5 FourStroke	JPN 0R067090 and up	NLA	N/A	27-803508 2	N/A
6 (60, 60J)	USA 1408611 - 2387383	N.L.A.	N/A	N/A	N/A
6 (60, 60J)	CAN 1958792 - 2387383	N.L.A.	N/A	N/A	N/A
6	USA 0A197112 - 0T800749	27-42364A92	N/A	N/A	N/A
6	BEL 9461526 and up	27-42364A92	N/A	N/A	N/A
6 FourStroke	JPN 0R000001 - 0R057259	27-8M0114820	N/A	27-803508	N/A
6 FourStroke	JPN 0R057260 - 0R067089	27-803508A05	N/A	27-803508	N/A
6 FourStroke	JPN 0R067090 and up	NLA	N/A	27-803508 2	N/A
7.5 (7.5, 75)	USA 2529895 and up	N.L.A.	N/A	N/A	N/A
7.5 (7.5, 75)	AUS 8015315 and up	N.L.A.	N/A	N/A	N/A
7.5 (7.5, 75)	BEL 9043194 and up	N.L.A.	N/A	N/A	N/A
7.5 (7.5, 75)	CAN 7028598 and up	N.L.A.	N/A	N/A	N/A
8	USA 0A197112 and up	27-42364A92	N/A	N/A	N/A
8	BEL 9461526 and up	27-42364A92	N/A	N/A	N/A
8 FourStroke(232 cc)	USA 0H000058 - 0H017349	N.L.A.	N/A	N.L.A.	N/A
8 FourStroke(232 cc)	USA 0G760300 - 0T178499	N.L.A.	N/A	N.L.A.	N/A
8 FourStroke(323 CC)	BEL 0P086824 - 0P325499	27-835427A00	N/A	27-8M0052705	N/A
8 FourStroke	JPN 0R042475 and up	27-835427A04	N/A	27-850836001	N/A
8 FourStroke	BEL 0P325500 and up	27-835427A04	N/A	27-850836001	N/A
9.8 (9.8, 110)	USA 1470349 and up	N.L.A.	N/A	N/A	N/A
9.8 (9.8, 110)	AUS 8015040 and up	N.L.A.	N/A	N/A	N/A
9.8 (9.8, 110)	BEL 9041439 and up	N.L.A.	N/A	N/A	N/A
9.8 (9.8, 110)	CAN 7027323 and up	N.L.A.	N/A	N/A	N/A
9.9	USA 0A197112 and up	27-42364A92	N/A	N/A	N/A
9.9	BEL 9461526 and up	27-42364A92	N/A	N/A	N/A
9.9 FourStroke(232 CC)	USA 0H000058 - 0H017349	N.L.A.	N/A	N.L.A.	N/A
9.9 FourStroke(323 CC)	USA 0G760300 - 0T979999	27-835427A00	N/A	27-8M0052705	N/A
9.9 FourStroke(323 CC)	BEL 0P075166 - 0P325499	27-835427A00	N/A	27-8M0052705	N/A
9.9 FourStroke	JPN 0R042475 and up	27-835427A04	N/A	27-850836001	N/A
9.9 FourStroke	BEL 0P325500 and up	27-835427A04	N/A	27-850836001	N/A
10 (100)	1290910 - 1499331	N.L.A.	N/A	N/A	N/A
10 (XR10/SEA PRO 10)	USA 0D038000 and up	27-42364A92	N/A	N/A	N/A
10 (XR10/SEA PRO 10)	BEL 9596000 and up	27-42364A92	N/A	N/A	N/A

Not all parts listed are available for the European, C.I.S., Africa and Middle East Markets.
For more information, please contact your local Mercury, Mariner, MerCruiser or Quicksilver Office.

POWERHEAD COMPONENTS

MERCURY® OUTBOARDS

Model		Serial # Range	Gasket Set	Head O-Rings	Head Gaskets	Head Seals
10 Magnum/Marathon	USA	0D038000 and up	27-42364A92	N/A	N/A	N/A
10 Magnum/Marathon	BEL	9596000 and up	27-42364A92	N/A	N/A	N/A
15 (150)		1290910 - 1499331	N.L.A.	N/A	N/A	N/A
15 (15, 15 Sea Pro/Marathon)	USA	0B292414 and up	27-42364A92	N/A	N/A	N/A
15 (15, 15 Sea Pro/Marathon)	BEL	9542620 and up	27-42364A92	N/A	N/A	N/A
15 XD Sea Pro/Marathon.	BEL	9927000 and up	27-41499A88	N/A	N/A	N/A
15 (Super 15)	USA	0B238464 and up	27-41499A88	N/A	N/A	N/A
15 (Super 15)	BEL	9507381 and up	27-41499A88	N/A	N/A	N/A
15 (Super 15)	CAN	0A730007 and up	27-41499A88	N/A	N/A	N/A
15 FourStroke, 323cc	USA	0G760300 and up	27-835427A00	N/A	27-8M0052705	N/A
15 FourStroke, 323cc	BEL	0P075166 and up	27-835427A00	N/A	27-8M0052705	N/A
15 FourStroke, 351cc	JPN	0R235949 - 0R833819	27-803663A08	N/A	27-812939T25	N/A
15 EFI FourStroke	JPN	0R833820 and up	8M0134438	N/A	8M0134437	N/A
18	USA	5837437 - 6416712	N.L.A.	N/A	N/A	N/A
18	AUS	8071973 and up	N.L.A.	N/A	N/A	N/A
18	BEL	9308306 - 9378115	N.L.A.	N/A	N/A	N/A
18	CAN	7173723 - 7207857	N.L.A.	N/A	N/A	N/A
18 (18XD)	USA	6416713 - 6443972	27-41499A88	N/A	N/A	N/A
18 (18XD)	BEL	9378116 - 9415100	27-41499A88	N/A	N/A	N/A
18 (18XD)	CAN	7207858 - 7209532	27-41499A88	N/A	N/A	N/A
20 (200)		1290910 - 3537530	N.L.A.	N/A	N/A	N/A
20 (20, 20XD, 200)	USA	3537531 - 6443972	N.L.A.	N/A	N/A	N/A
20 (20, 20XD, 200)	AUS	8006265 and up	N.L.A.	N/A	N/A	N/A
20 (20, 20XD, 200)	BEL	9016254 - 9415100	N.L.A.	N/A	N/A	N/A
20 (20, 20XD, 200)	CAN	7012358 - 7209532	N.L.A.	N/A	N/A	N/A
20 (20, 20XD, 200)	USA	6443973 - 0T800999	27-41499A88	N/A	N/A	N/A
20 (20, 20XD, 200)	BEL	9415101 and up	27-41499A88	N/A	N/A	N/A
20 (20, 20XD, 200)	CAN	7209533 and up	27-41499A88	N/A	N/A	N/A
20 JET	USA	0G044027 and up	27-41499A88	N/A	N/A	N/A
20 JET	BEL	9807909 and up	27-41499A88	N/A	N/A	N/A
20 FourStroke	JPN	0R235168 - 0R833819	27-803663A08	N/A	27-812939T25	N/A
20 EFI FourStroke	JPN	0R833820 and up	8M0134438	N/A	8M0134437	N/A
25 (250)		1290910 - 1499331	N.L.A.	N/A	N/A	N/A
25	USA	5705532 - 6416712	N.L.A.	N/A	N/A	N/A
25	AUS	8073158 and up	N.L.A.	N/A	N/A	N/A
25	BEL	9315316 - 9378115	N.L.A.	N/A	N/A	N/A
25 (25, 25XD)	USA	6416713 - 0T979999	27-41499A88	N/A	N/A	N/A
25 (25, 25XD)	BEL	9378116 - 0P325499	27-41499A88	N/A	N/A	N/A
25 (25, 25XD)	CAN	7207858 and up	27-41499A88	N/A	N/A	N/A
25 LIGHTNING(3 cyl)	USA	0E268781 and up	N.L.A.	N/A	N/A	N/A
25 FourStroke (Carb)	USA	0G590000 - 1B344298	27-830270A02	N/A	27-8M0049885	N/A
25 FourStroke (EFI)	JPN	0R106999 and up	27-8M0079064	N/A	27-898101T41	N/A
25 FourStroke JET	JPN	0R165086 and up	27-8M0079064	N/A	27-898101T41	N/A
30 (300)		127884 and up	N.L.A.	N/A	N/A	N/A
30 (2 cyl)(644cc)	USA	0G053314 and up	27-822420A94	N/A	N/A	N/A
30 LIGHTNING(430cc)	USA	0G575500 and up	27-8M0084273	N/A	N/A	N/A
30 (4-Stroke)(3 cyl) Carb	USA	0G760300 - 0T408999	27-825231A99	N/A	27-834777	N/A
30 (4-Stroke)(3 cyl) Carb	USA	0T409000 - 1B226999	27-825231A02	N/A	27-834777	N/A
30 (4-Stroke)(3 cyl) Carb	BEL	0P153500 - 0P400999	27-825231A02	N/A	27-834777	N/A
30 (4-Stroke)(3 cyl) EFI	USA	0T409000 - 1B226999	27-859352A02	N/A	27-834777	N/A
30 FourStroke (EFI)	JPN	0R106999 and up	27-8M0079064	N/A	27-898101T41	N/A
30 JET (40 hp)(4 cyl)	USA	0C159200 and up	27-85491A90	N/A	N/A	N/A
30 JET (40 hp)(4 cyl)	BEL	9570790 and up	27-85491A90	N/A	N/A	N/A
30 JET (50 hp)(3 cyl)	USA	0G590000 and up	27-828553A97	N/A	N/A	N/A

POWERHEAD COMPONENTS

MERCURY® OUTBOARDS

Model	Serial # Range	Gasket Set	Head O-Rings	Head Gaskets	Head Seals
30 JET (50 hp)(3 cyl)	BEL 9973100 and up	27-828553A97	N/A	N/A	N/A
35 (350, 35A)	127884 and up	N.L.A.	N/A	N/A	N/A
35 (2 cyl)	USA 6445653 - 0B110788	27- 78028A78	N/A	N/A	N/A
35 (2 cyl)	BEL 9384476 - 9466646	27- 78028A78	N/A	N/A	N/A
35 (2 cyl)	CAN 7209608 and up	27- 78028A78	N/A	N/A	N/A
35 (2 cyl)	USA 0B110789 and up	N.L.A.	N/A	N/A	N/A
35 (2 cyl)	BEL 9466647 and up	N.L.A.	N/A	N/A	N/A
40 (400)	1279685 - 3336257	N.L.A.	N/A	N/A	N/A
40 (40, 402)(2 cyl.)	USA 3336258 - 0G053313	27- 78028A78	N/A	N/A	N/A
40 (40, 402)(2 cyl.)	AUS 8002335 and up	27- 78028A78	N/A	N/A	N/A
40 (40, 402)(2 cyl.)	BEL 3339688 and up	27- 78028A78	N/A	N/A	N/A
40 (2 cyl)	CAN 3340783 and up	27- 78028A78	N/A	N/A	N/A
40 (2 cyl)(644cc)	USA 0G053314 and up	27-822420A94	N/A	N/A	N/A
40 (4 cyl)	USA 0C159200 and up	27- 85491A90	N/A	N/A	N/A
40 (4 cyl)	BEL 9570790 and up	27- 85491A90	N/A	N/A	N/A
40 (3 cyl)	USA 0G531301 and up	27-828553A97	N/A	N/A	N/A
40 (3 cyl)	BEL 9973100 and up	27-828553A97	N/A	N/A	N/A
40 Italy (4-Stroke)	USA 0G231123 - 0T178499	27-832013A96	N/A	27-825032	N/A
40 (4-Stroke)(3 cyl) Carb	USA 0G760300 - 0T408999	27-825231A99	N/A	27-834777	N/A
40 (4-Stroke)(3 cyl) Carb	USA 0T409000 and up	27-825231A02	N/A	27-834777	N/A
40 (4-Stroke)(3 cyl) Carb	BEL 0P153500 and up	27-825231A02	N/A	27-834777	N/A
40 (4-Stroke)(3 cyl) EFI	USA 0T409000 and up	27-859352A02	N/A	27-834777	N/A
40 (4-Stroke)(3 cyl) EFI	CHN 1C000001 and up	27-859352A02	N/A	27-834777	N/A
40 (4-Stroke)(4 cyl) Carb	USA 0T228405 - 0T598999	27-859352A01	N/A	27-8M0118179	N/A
40 (4-Stroke)(4 cyl) EFI	USA 0T409000 and up	27-883599A02	N/A	27-8M0118179	N/A
40 (4-Stroke)(4 cyl) EFI	CHN 1C000001 and up	27-883599A02	N/A	27-8M0118179	N/A
45 (4 cyl)	USA 5531630 - 0B110788	N.L.A.	N/A	N/A	N/A
45 (4 cyl)	AUS 8063985 and up	N.L.A.	N/A	N/A	N/A
45 (4 cyl)	BEL 9248006 - 9466691	N.L.A.	N/A	N/A	N/A
45 (4 cyl)	CAN 7143688 - 0A719280	N.L.A.	N/A	N/A	N/A
45 (4 cyl)	USA 0B110789 and up	27- 85491A90	N/A	N/A	N/A
45 (4 cyl)	BEL 9466692 and up	27- 85491A90	N/A	N/A	N/A
45 (4 cyl)	CAN 0A719281 and up	27- 85491A90	N/A	N/A	N/A
45 JET	USA 0D000750 and up	27-812867A97	N/A	N/A	N/A
450	1476510 - 1531568	N.L.A.	N/A	N/A	N/A
45 Bodensee(4-Stroke)	USA 0G231123 - 0T178499	27-832013A96	N/A	27-825032	N/A
50 (500) (4 cyl)	1421113 - 2116317	N.L.A.	N/A	N/A	N/A
50 (500) (4 cyl)	CAN 1755549 - 2097444	N.L.A.	N/A	N/A	N/A
50 (500) (4 cyl)	USA 2116318 and up	N.L.A.	N/A	N/A	N/A
50 (500) (4 cyl)	CAN 2097445 and up	N.L.A.	N/A	N/A	N/A
50 (500) (4 cyl)	AUS 2863739 and up	N.L.A.	N/A	N/A	N/A
50 (500) (4 cyl)	BEL 9001581 and up	N.L.A.	N/A	N/A	N/A
50 (3cyl)	USA 6428681 - 0B122929	27- 88449A32	N/A	N/A	N/A
50 (3cyl)	BEL 9385911 - 9469199	27- 88449A32	N/A	N/A	N/A
50 (3cyl)	CAN 7208333 - 0A721307	27- 88449A32	N/A	N/A	N/A
50 (3cyl)	USA 0B122930 - 0D000749	27- 43779A87	N/A	N/A	N/A
50 (3cyl)	BEL 9469200 - 9683054	27- 43779A87	N/A	N/A	N/A
50 (3cyl)	CAN 0A721308 and up	27- 43779A87	N/A	N/A	N/A
50 (3cyl)	USA 0D000750 - 0G589999	27-812867A97	N/A	N/A	N/A
50 (3cyl)	BEL 9683055 - 9973099	27-812867A97	N/A	N/A	N/A
50 (3cyl)	USA 0G590000 and up	27-828553A97	N/A	N/A	N/A
50 (3cyl)	BEL 9973100 and up	27-828553A97	N/A	N/A	N/A

Not all parts listed are available for the European, C.I.S., Africa and Middle East Markets.
For more information, please contact your local Mercury, Mariner, MerCruiser or Quicksilver Office.

POWERHEAD COMPONENTS

MERCURY® OUTBOARDS

Model	Serial # Range	Gasket Set	Head O-Rings	Head Gaskets	Head Seals
50 FourStroke	USA 0G231123 - 0T178499	27-832013A96	N/A	27-825032	N/A
50 FourStroke	BEL 9944807 - 0P095599	27-832013A96	N/A	27-825032	N/A
50 (4-Stroke)(4 cyl) Carb	USA 0T178500 - 0T598999	27-859352A01	N/A	27-8M0118179	N/A
50 (4-Stroke)(4 cyl) Carb	BEL 0P094500 - 0P206999	27-859352A01	N/A	27-8M0118179	N/A
50 FourStroke (4 cyl) EFI	USA 0T409000 and up	27-883599A02	N/A	27-8M0118179	N/A
50 FourStroke (4 cyl) EFI	BEL 0P153500 and up	27-883599A02	N/A	27-8M0118179	N/A
50 FourStroke (4 cyl) EFI	CHN 1C000001 and up	27-883599A02	N/A	27-8M0118179	N/A
55 (3cyl)	USA 6428681 - 0B122929	27-88449A32	N/A	N/A	N/A
55 (3cyl)	BEL 9385911 - 9469199	27-88449A32	N/A	N/A	N/A
55 (3cyl)	CAN 7208333 - 0A721307	27-88449A32	N/A	N/A	N/A
55 (3cyl)	USA 0B122930 - 0D000749	27-43779A87	N/A	N/A	N/A
55 (3cyl)	BEL 9469200 - 9683054	27-43779A87	N/A	N/A	N/A
55 (3cyl)	CAN 0A721308 and up	27-43779A87	N/A	N/A	N/A
55 (3cyl)	USA 0D000750 and up	27-812867A97	N/A	N/A	N/A
55 (3cyl)	BEL 9683055 and up	27-812867A97	N/A	N/A	N/A
60 (600) (6 cyl)	1303411 - 1542744	N.L.A.	N/A	N/A	N/A
60 (3cyl)	USA 6428681 - 0B122929	27-88449A32	N/A	N/A	N/A
60 (3cyl)	BEL 9385911 - 9469199	27-88449A32	N/A	N/A	N/A
60 (3cyl)	CAN 7208333 - 0A721307	27-88449A32	N/A	N/A	N/A
60 (3cyl)	USA 0B122930 - 0D000749	27-43779A87	N/A	N/A	N/A
60 (3cyl)	BEL 9469200 - 9683054	27-43779A87	N/A	N/A	N/A
60 (3cyl)	CAN 0A721308 and up	27-43779A87	N/A	N/A	N/A
60 (3cyl)	USA 0D000750 and up	27-812867A97	N/A	N/A	N/A
60 (3cyl)	BEL 9683055 and up	27-812867A97	N/A	N/A	N/A
60 (4-Stroke)(4 cyl) Carb	USA 0T178500 - 0T598999	27-859352A01	N/A	27-8M0118179	N/A
60 (4-Stroke)(4 cyl) Carb	BEL 0P094500 - 0P206999	27-859352A01	N/A	27-8M0118179	N/A
60 (4-Stroke)(4 cyl) EFI	USA 0T409000 and up	27-883599A02	N/A	27-8M0118179	N/A
60 FourStroke (4 cyl) EFI	BEL 0P153500 and up	27-883599A02	N/A	27-8M0118179	N/A
60 FourStroke (4 cyl) EFI	CHN 1C000001 and up	27-883599A02	N/A	27-8M0118179	N/A
65 (650) (4 cyl)	1542745 - 1765043	N.L.A.	N/A	N/A	N/A
65 (650) (4 cyl)	1765044 - 3293183	N.L.A.	N/A	N/A	N/A
65 (650)(3 cyl)	USA 3293184 - 4382056	N.L.A.	N/A	N/A	N/A
65 (650)(3 cyl)	AUS 8006640 - 8042349	N.L.A.	N/A	N/A	N/A
65 (650)(3 cyl)	BEL 9020074 - 9112988	N.L.A.	N/A	N/A	N/A
65 (650)(3 cyl)	CAN 7013633 - 7073472	N.L.A.	N/A	N/A	N/A
65 (650)(3 cyl)	USA 4382057 - 4571651	27-88449A32	N/A	N/A	N/A
65 (650)(3 cyl)	BEL 9112989 - 9135824	27-88449A32	N/A	N/A	N/A
65 (650)(3 cyl)	CAN 7073473 - 7087822	27-88449A32	N/A	N/A	N/A
70 (700) (6 cyl)	1296411 - 1566239	N.L.A.	N/A	N/A	N/A
70 (3 cyl)	USA 4571652 - 0A996141	27-88449A32	N/A	N/A	N/A
70 (3 cyl)	AUS 8042350 and up	27-88449A32	N/A	N/A	N/A
70 (3 cyl)	BEL 9135825 - 9385910	27-88449A32	N/A	N/A	N/A
70 (3 cyl)	CAN 7087823 - 7208332	27-88449A32	N/A	N/A	N/A
70 (3 cyl)	USA 0A996142 and up	27-43004A99	N/A	N/A	N/A
70 (3 cyl)	BEL 9483121 and up	27-43004A99	N/A	N/A	N/A
75 (4 cyl)	USA 6432901 and up	27-73645A87	N/A	N/A	N/A
75 (4 cyl)	BEL 9393856 and up	27-73645A87	N/A	N/A	N/A
75 (4 cyl)	CAN 7208573 and up	27-73645A87	N/A	N/A	N/A
75 (3 cyl) Optimax	USA 0T801000 and up	27-879855A04	N/A	N/A	N/A
75 (4-Stroke)(Carb)	USA 0G960500 - 1B226999	27-804345A02	N/A	27-804115 1	N/A
75 FourStroke (EFI)(1596cc)	USA 1B172291 - 1B366822	27-858732A03	N/A	27-804115 1	N/A
75/80 FourStroke (EFI)(1731cc)	USA 1B366823 - 2B094995	27-897534A07	N/A	27-8M0024565	N/A
75/80 FourStroke (2.1L)	USA 2B094996 and up		N/A	27-8M0090776	N/A
80 (800)(6 cyl)	1335465 - 1566239	N.L.A.	N/A	N/A	N/A

POWERHEAD COMPONENTS

MERCURY® OUTBOARDS

Model	Serial # Range	Gasket Set	Head O-Rings	Head Gaskets	Head Seals
80 (80,800)(4 cyl)	2559001 - 3493912	N.L.A.	N/A	N/A	N/A
80 (80,800)(4 cyl)	USA 4831999 - 6432900	27- 73645A87	N/A	N/A	N/A
80 (80,800)(4 cyl)	AUS 8050200 and up	27- 73645A87	N/A	N/A	N/A
80 (80,800)(4 cyl)	BEL 9177626 - 9393855	27- 73645A87	N/A	N/A	N/A
80 (80,800)(4 cyl)	CAN 7110998 - 7208572	27- 73645A87	N/A	N/A	N/A
80 (3 cyl)	USA 0A996142 and up	27- 43004A99	N/A	N/A	N/A
80 (3 cyl)	BEL 9483121 and up	27- 43004A99	N/A	N/A	N/A
80 JET (4 cyl)	USA 0D283222 and up	27- 13461A99	N/A	N/A	N/A
80 JET (4 cyl)	BEL 9793577 and up	27- 13461A99	N/A	N/A	N/A
90 (900)(6 cyl)	1766824 - 1869775	N.L.A.	N/A	N/A	N/A
90 (90, 900)(6 cyl)	USA 4845301 and up	27- 85653A87	N/A	N/A	N/A
90 (90, 900)(6 cyl)	CAN 7111698 and up	27- 85653A87	N/A	N/A	N/A
90 (90, 900)(6 cyl)	AUS 8060545 and up	27- 85653A87	N/A	N/A	N/A
90 (3 cyl)	USA 0A996142 and up	27- 43004A99	N/A	N/A	N/A
90 (3 cyl)	BEL 9483121 and up	27- 43004A99	N/A	N/A	N/A
90 (3 cyl) Optimax	USA 0T801000 and up	27-879855A04	N/A	N/A	N/A
90 (4-Stroke)	USA 0G960500 - 1B226999	27-804345A02	N/A	27- 804115 1	N/A
90 FourStroke (EFI)(1596cc)	USA 1B172291 - 1B366822	27-858732A03	N/A	27- 804115 1	N/A
90/100 FourStroke (EFI)(1731cc)	USA 1B366823 - 2B094995	27-897534A07	N/A	27- 8M0024565	N/A
90/100 FourStroke (2.1L)	USA 2B094996 and up		N/A	27- 8M0090776	N/A
95 (950)(6 cyl)	1869776 - 2318585	N.L.A.	N/A	N/A	N/A
100 (1000)(6 cyl)	1464949 - 1768403	N.L.A.	N/A	N/A	N/A
100 (1000)(6 cyl)	1768404 - 2641854	N.L.A.	N/A	N/A	N/A
100 (1000)(6 cyl)	2641855 - 3253111	N.L.A.	N/A	N/A	N/A
100 (4 cyl)	USA 0B209468 and up	27- 13461A99	N/A	N/A	N/A
100 (4 cyl)	BEL 9523034 and up	27- 13461A99	N/A	N/A	N/A
105 JET (V-6)	USA 0D082000 and up	27-815791A92(1)	N/A	27- 18785T(1)	N/A
110 (1100)(6 cyl)	1870204 - 2314955	N.L.A.	N/A	N/A	N/A
115 (115, 1150)(6 cyl)	2836019 - 3525440		N/A	N/A	N/A
115 (115, 1150)(6 cyl)	USA 3525441 and up	27- 85653A87	N/A	N/A	N/A
115 (115, 1150)(6 cyl)	AUS 8008665 and up	27- 85653A87	N/A	N/A	N/A
115 (115, 1150)(6 cyl)	CAN 7112248 and up	27- 85653A87	N/A	N/A	N/A
115 (4 cyl)	USA 0C100000 and up	27- 13461A99	N/A	N/A	N/A
115 (4 cyl)	BEL 9559771 and up	27- 13461A99	N/A	N/A	N/A
115 (3 cyl) Optimax	USA 0T801000 and up	27-879855A04	N/A	N/A	N/A
115 Pro XS	USA 1B751825 and up	27-879855A04	N/A	N/A	N/A
115 FourStroke (EFI)(1741cc)	USA 0T209000 - 1B366822	27-858732T02	N/A	27- 804115 1	N/A
115 FourStroke (EFI)(1731cc)	USA 1B366823 - 2B094995	27-897534A07	N/A	27- 8M0024565	N/A
115 FourStroke (2.1L)	USA 2B094996 and up			27- 8M0090776	
1250 (6 cyl)	ALL and up	N.L.A.	N/A	N/A	N/A
125 (4 cyl)	USA 0D283222 and up	27- 13461A99	N/A	N/A	N/A
125 (4 cyl)	BEL 9793577 and up	27- 13461A99	N/A	N/A	N/A
125 (3 cyl) Optimax	USA 1B736885 and up	27-879855A04	N/A	N/A	N/A
135 (1350)(6 cyl)	ALL and up		N/A	N/A	N/A
140 (140, 1400)(6 cyl)	USA 3293234 - 3502805	27- 85653A87	N/A	N/A	N/A
140 (140, 1400)(6 cyl)	USA 4865678 and up	27- 85653A87	N/A	N/A	N/A
140 (140, 1400)(6 cyl)	AUS 8052650 and up	27- 85653A87	N/A	N/A	N/A
140 (140, 1400)(6 cyl)	CAN 7112773 and up	27- 85653A87	N/A	N/A	N/A
150 (1500)(6 cyl)	USA 3502806 - 5327662	27- 85653A87	N/A	N/A	N/A
150 (1500)(6 cyl)	AUS 8005615 - 8052649	27- 85653A87	N/A	N/A	N/A
150 (1500)(6 cyl)	CAN 7010533 - 7112772	27- 85653A87	N/A	N/A	N/A
V-135	USA 0A904646 - 0C239552	NLA	N/A	27- 96281T01	N/A
V-135	USA 0C239553 - 0G960499	27-815791A92(1)	N/A	27- 18785T(1)	N/A
V-135	USA 0G960500 - 0T178499	27-815791A00(1)	N/A	27- 18785T(1)	N/A

Not all parts listed are available for the European, C.I.S., Africa and Middle East Markets.
 For more information, please contact your local Mercury, Mariner, MerCruiser or Quicksilver Office.

POWERHEAD COMPONENTS

MERCURY® OUTBOARDS

Model	Serial # Range	Gasket Set	Head O-Rings	Head Gaskets	Head Seals
V-135 DFI	USA 0G590000 - 0G960499	27-8M0046714(1)	N/A	NLA(1)	N/A
V-135 DFI	USA 0G960500 and up	27-8M0046714(2)	859772 1(2)	N/A	858452 1(2)
135 Verado	USA 1B227000 and up	27-896142A07	N/A	27-8M0024565	N/A
	BEL 0P419487 and up				
V-140 JET	USA 0D082000 - 0G960499	27-815791A92(1)	N/A	27-822844T05(1)	N/A
V-150 (150, 1500)	USA 4868998 - 6042945	N.L.A.	N/A	27- 79583 1	N/A
V-150	USA 6042946 - 0C239552	N.L.A.	N/A	27- 96281T01	N/A
V-150	USA 0C239553 - 0G960499	27-815791A92(1)	N/A	27- 18785T(1)	N/A
V-150	USA 0G960500 and up	27-8M0046714(2)	859772 1(2)	N/A	858452 1(2)
V-150 (XR4/MAGNUM II)	USA 0B242885 - 0C239552	N.L.A.	N/A	27- 41247T01	N/A
V-150 (XR4)	USA 0C239553 - 0D081999	27-815791A92(1)	N/A	27- 18786T(1)	N/A
V-150 (XR6/MAGNUM III)	USA 0D082000 - 0G960499	27-815791A92(1)	N/A	27-822844T05(1)	N/A
V-150 (XR6/MAGNUM III)	USA 0G960500 and up	27-8M0046714(2)	859772 1(2)	N/A	858452 1(2)
V-150 EFI	USA 0D082000 - 0G960499	27-815791A92(1)	N/A	27-822844T05(1)	N/A
V-150 EFI	USA 0G960500 - 0T408999	27-815791A00(2)	859772 1(2)	N/A	858452 1(2)
V-150 EFI	USA 0T409000 and up	27-8M0046715(3)	859772 1(3)	N/A	858452 1
V-150 DFI	USA 0G590000 - 0G960499	27-8M0046714(1)	N/A	NLA(1)	N/A
V-150 DFI	USA 0G960500 and up	27-8M0046714(2)	859772 1(2)	N/A	858452 1(2)
150 ProXS	USA 1B690542 and up	27-8M0046714(2)	859772 1(2)	N/A	858452 1(2)
150 EFI FourStroke	USA 1B905505 and up	27-8M0057763		27-8M6000366	
150 Verado	USA 1B227000 and up	27-896142A07	N/A	27-8M0024565	N/A
	BEL 0P419487 and up				
V-175 (175,1750)	USA 4301235 - 6618750	N.L.A.	N/A	27- 79583 1	N/A
V-175 (175,1750)	AUS 8058870 and up	N.L.A.	N/A	27- 79583 1	N/A
V-175	USA 6618751 - 0C239552	N.L.A.	N/A	27- 41247T01	N/A
V-175	USA 0C239553 - 0D081999	27-815791A92(1)	N/A	27- 18786T(1)	N/A
V-175	USA 0D082000 - 0G960499	27-815791A92(1)	N/A	27-822844T05(1)	N/A
V-175 EFI	USA 0D00750 - 0D081999	27-815791A92(1)	N/A	27- 18786T(1)	N/A
V-175 EFI	USA 0D082000 - 0G960499	27-815791A92(1)	N/A	27-822844T05(1)	N/A
V-175 EFI	USA 0G960500 - 0T408999	27-815791A00(2)	859772 1(2)	N/A	858452 1(2)
V-175 EFI	USA 0T409000 - 0T800999	27-8M0046715(3)	859772 1(3)	N/A	858452 1
V-175 DFI	USA 0T178500 and up	27-8M0046714(2)	859772 1(2)	N/A	858452 1(2)
V-175 Pro XS	USA 1B516339 and up	27-8M0046714(2)	859772 1(2)	N/A	858452 1(2)
175 Verado	USA 1B227000 and up	27-896142A07	N/A	27-8M0024565	N/A
	BEL 0P419487 and up				
V-200 (200,2000)	USA 4839034 - 6073191	N.L.A.	N/A	27- 41244T02	N/A
V-200 (200,2000)	AUS 8061595 - 8065672	N.L.A.	N/A	27- 41244T02	N/A
V-200	USA 6073192 - 6203990	27- 89221A80	N/A	27- 41244T02	N/A
V-200	USA 6203991 - 0C291519	27- 89221A88	N/A	27- 41247T01	N/A
V-200	USA 0C291520 - 0D081999	27-815791A92(1)	N/A	27-822844T05(1)	N/A
V-200	USA 0D082000 - 0G960499	27-815791A92(1)	N/A	27-822844T05(1)	N/A
V-200	USA 0G960500 and up	27-815791A00(2)	859772 1(2)	N/A	858452 1(2)
V-200 EFI	USA 0C100861 - 0C291519	27- 14697A87	N/A	27- 41247T01	N/A
V-200 EFI	USA 0C291520 - 0G960499	27-815791A92(1)	N/A	27-822844T05(1)	N/A
V-200 EFI	USA 0G960500 - 0T408999	27-815791A00(2)	859772 1(2)	N/A	858452 1(2)
V-200 EFI (2.5L)	USA 0T409000 and up	27-8M0046715(3)	859772 1(3)	N/A	858452 1
V-200 EFI (3.0L)	USA 0T750164 - 0T598999	27-832934A00(3)	878453(3)	N/A	818574
V-200 EFI (3.0L)	USA 0T599000 and up	27-832934A00(2)	884391(2)	N/A	818574
V-200 DFI (3.0L)	USA 0G386496 - 0G589999	N.L.A.	25-818573	N/A	818574
V-200 DFI (3.0L)	USA 0G590000 - 0G960499	NLA(2)	25-818573(2)	N/A	818574(2)
V-200 DFI (3.0L)	USA 0G960500 - 0T178499	27-832934A00(3)	25-818573(3)	N/A	818574
V-200 DFI (3.0L)	USA 0T178500 - 0T598999	27-832934A00(3)	878453(3)	N/A	818574
V-200 DFI (3.0L)	USA 0T599000 and up	27-832934A00(3)	884391(3)	N/A	818574

POWERHEAD COMPONENTS

MERCURY® OUTBOARDS

Model	Serial # Range	Gasket Set	Head O-Rings	Head Gaskets	Head Seals
V-200 Pro XS	USA 1B504989 and up	27-832934A00(3)	884391(3)	N/A	818574
200 4 CYL., Verado	USA 1B517159 and up	27-896142A07	N/A	27-8M0024565	N/A
	BEL 0P514869 and up				
200 6 CYL., Verado	USA 0T980000 and up	27-880552A07	N/A	27-8M0033476	N/A
	BEL 0P409357 and up				
V-220	USA 0B117316 and up	27-14697A87	N/A	27-41247T01	N/A
V-225	USA 5628028 and up	27-89221A80	N/A	27-41244T02	N/A
V-225	USA 0D280813 - 0T178499	27-814195A93	25-818573	N/A	818574
V-225	USA 0T178500 - 0T408999	27-814195A93	878453	N/A	818574
V-225 SEA PRO	USA 0G245605 - 0T408999	27-814195A93	25-818573	N/A	818574
V-225 EFI (3.0L)	USA 0G129222 - 0T408999	27-814195A93	25-818573	N/A	818574
V-225 EFI (3.0L)	USA 0T409000 - 0T598999	27-832934A00(3)	878453(3)	N/A	818574
V-225 EFI (3.0L)	USA 0T599000 and up	27-832934A00(3)	884391(3)	N/A	818574
V-225 EFI (FourStroke) Starboard	USA 0T653945 - 0T807875		N/A	27-887848002	N/A
V-225 EFI (FourStroke) Port	USA 0T653945 - 0T807875			27-887848003	
V-225 EFI (FourStroke) Starboard	USA 0T807876 and up	27-887810A04	N/A	27-887848002	N/A
V-225 EFI (FourStroke) Port	USA 0T807876 and up			27-887848003	
V-225 DFI (3.0L)	USA 0G590000 - 0G960499	N.L.A.(3)	25-818573(3)	N/A	818574
V-225 DFI (3.0L)	USA 0G960500 - 0T178499	27-832934A00(3)	25-818573(3)	N/A	818574
V-225 DFI (3.0L)	USA 0T178500 - 0T598999	27-832934A00(3)	878453(3)	N/A	818574
V-225 DFI (3.0L)	USA 0T599000 and up	27-832934A00(3)	884391(3)	N/A	818574
V-225 Pro XS	USA 1B104549 and up	27-841220A03(3)	884391(3)	N/A	818574
225 Verado	USA 0T980000 and up	27-880552A07	N/A	27-8M0033476	N/A
	BEL 0P409357 and up				
V-250 EFI (3.0L)	USA 0T409000 - 0T598999	27-832934A00(3)	878453(3)	N/A	818574
V-225 EFI (3.0L)	USA 0T599000 and up	27-832934A00(3)	884391(3)	N/A	818574
V-250 (3.4L)	USA 0C101891 and up	N.L.A.	N.L.A.	N/A	N.L.A.
V-250 EFI (3.0L)	USA 0G129222 - 0T408999	27-814195A93	25-818573	N/A	818574
V-250 DFI (3.0L)	USA 1B528615 and up	27-841220A03(3)	884391(3)	N/A	818574
V-250 Pro XS	USA 1B426561 and up	27-841220A03(3)	884391(3)	N/A	818574
250 Verado	USA 0T980000 and up	27-880552A07	N/A	27-8M0033476	N/A
	BEL 0P409357 and up				
V-275 (3.4L)	USA 0C101891 and up	N.L.A.	N.L.A.	N/A	N.L.A.
275 Verado	USA 0T980000 and up	27-880552A07	N/A	27-8M0033476	N/A
	BEL 0P409357 and up				
V-300 (3.4L)	USA 5611648 and up	N.L.A.	N.L.A.	N/A	N.L.A.
300 Verado	USA 1B517434 and up	27-880552A07	N/A	27-8M0033476	N/A
	BEL 0P520553 and up				

(1) Head gaskets are not included in Gasket set

(2) Cylinder head O-rings and seal not included in gasket kit.

(3) Cylinder head O-rings not included in gasket kit.

GEAR CASE COMPONENTS

GEAR CASE COMPONENTS

POINT OF SALE DRAIN SCREWS AND SEALS

FILL AND DRAIN SCREW KIT



22-8M0083060

Includes the screw and the tear resistant rubber coated seal.
Fits Mercury/Mariner outboards of Japanese origin that use an 8x1.25 metric threaded screw.
Mercury Branded, Clamshell Package Point of Sale Packaged.

22-8M0083059

Includes the screw and the tear resistant rubber coated seal.
Fits Mercury/Mariner outboards of Japanese origin that use an 8x1.25 metric threaded screw.
Quicksilver Branded, Clamshell Package Point of Sale Packaged.

DRAIN SCREW GASKET



8M0082880

Features a tear resistant material bonded to a metal washer.
Fits the metric gearcase drain screw found on Mercury/Mariner outboards F2.5/3.5 hp. (MY 2006 and newer), F4/5/6 hp. (MY 2002 and newer), F8/9.9 hp. (MY 2005 and newer), F15/20 hp. (351cc, MY 2008 and newer) and the F25/30 hp. (EFI, MY 2006 and newer).

GEARCASE DRAIN SCREW



22-8M0058388

Magnetic screw with premium drain screw seal.
Fits Mercury MerCruiser I, R, MR, Alpha One, TR, TRS, and all outboards with Magnetic gear lube fill or vent 3/8-16 UNC threaded screws.
Priced individually, sold @ multiples of 2
Mercury Branded, Clamshell Package Point of Sale Packaged.

22-8M0058389

Magnetic screw with premium drain screw seal.
Fits Mercury MerCruiser I, R, MR, Alpha One, TR, TRS, and all outboards with Magnetic gear lube fill or vent 3/8-16 UNC threaded screws.
Priced individually, sold @ multiples of 2
Quicksilver Branded, Clamshell Package Point of Sale Packaged.

DRAIN SCREW SEAL



26-8M0058390

A superior seal with resistance to tearing, cracking or splitting. There are 2 seals included in each clamshell's individual price.
Used with the gear case 3/8-16 drain/fill screw found on all Mercury MerCruiser and most Mercury Outboards except those of Japanese origin.
Priced individually, sold @ multiples of 2
Mercury Branded, Clamshell Package Point of Sale Packaged.

26-8M0058391

A superior seal with resistance to tearing, cracking or splitting. There are 2 seals included in each clamshell's individual price.
Used with the gear case 3/8-16 drain/fill screw found on all Mercury MerCruiser and most Mercury Outboards except those of Japanese origin.
Priced individually, sold @ multiples of 2
Quicksilver Branded, Clamshell Package Point of Sale Packaged.

DRAIN SCREW GASKET



12-19183K02

There are 4 gaskets included in each clamshell's individual price.
Used with the 3/8-16 drain/fill screw found on all MerCruiser and most Mercury/Mariner outboards except Verado and those of Japanese origin.
Priced individually, sold @ multiples of 2
Mercury Branded, Clamshell Package Point of Sale Packaged.

12-19183Q02

There are 4 gaskets included in each clamshell's individual price.
Used with the 3/8-16 drain/fill screw found on all MerCruiser and most Mercury/Mariner outboards except Verado and those of Japanese origin.
Priced individually, sold @ multiples of 2
Quicksilver Branded, Clamshell Package Point of Sale Packaged.

FRONT WATER INLET PLUG KITS

WATER INLET PLUG KIT



895764A01

Contains two plugs, o-ring and shift shaft gasket.
Plugs the front low water pick-up on the gearcase for the 3.0L EFI/Optimax outboards with the shift shaft bushing assembly that is fastened with 2 screws.

WATER INLET PLUG KIT



8M0052921

Contains plugs and gasket to seal the low water pickups from injecting debris into the engine water cooling passages.
Fits the Verado gearcase and the Torquemaster II with the shift shaft bushing fastened with 4 screws.

LOWER UNIT SEAL KITS

SEAL KIT

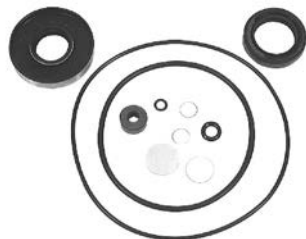

FK1061

SEAL KIT



FK1063-2

SEAL KIT



26-41365A 3

SEAL KIT



26-43035A 4

Fits Mercury/Mariner 100/115/125 hp, 2-cycle outboard (USA 0B209468 and Newer, BEL 9523034) with either 3 or 6 jaw reverse clutch.

SEAL KIT



26-43035A05

SEAL KIT



26-55682A 1

GEAR CASE COMPONENTS

MERCURY® OUTBOARDS

SEAL KIT



26- 66303A 1

GASKET SET

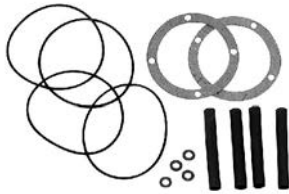

27- 72863A88

SEAL KIT



26- 77066A 1

SEAL KIT



26- 79831A 1

SEAL KIT



26- 85090A 2

SEAL KIT



26- 89238A 2

Fits Mercury / Mariner 135/150 V-6 outboards (USA 0A904646 and Newer) and 175/200 V-6 outboards (USA 6618751 and Newer).

SEAL KIT



26- 814669A 2

SEAL KIT



26- 816575A 4

Gear Housing

SEAL KIT



26- 816575A 5

SEAL KIT



26-820645A 1

SEAL KIT



823547A 2

SEAL KIT



823547A03

SEAL KIT

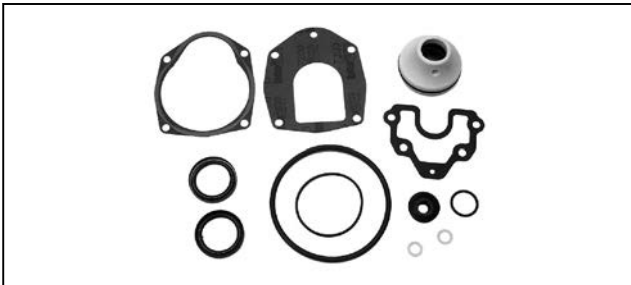

26-830749A01

Fits the 4.80 inch Torpedo gearcase on the FourStroke Verado outboard beginning with Model Year 2005.

LOWER UNIT GASKET SET

Image not Available.

27-8M0089636

Fits the F25/30 EFI FourStroke outboards 0R051710 and UP.

SEAL KIT



8M0057716

Fits Mercury/Mariner 150 EFI FourStroke outboards beginning with serial number 1B905505 and above.

SEAL KIT

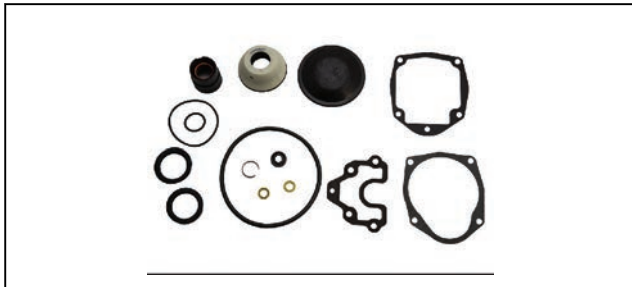

8M0065064

Fits the 5.44 inch Torpedo diameter gearcase on a 6 cylinder FourStroke Verado outboard.

SEAL KIT



27-8M0077448

Seals a lower unit gearcase. Fits the 20 hp. FourStroke outboard, 0R235168 and above and the 15 hp. FourStroke outboard, 0R235949 and above.

SEAL KIT



27-8M0082878

GEAR CASE COMPONENTS

SEAL KIT



27-8M0082881

Fits the 2.5/3.5 hp. FourStroke outboard, serial number 0R131842 & above.

SEAL KIT

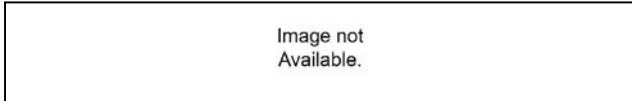

27-8M0134073

LOWER UNIT GASKET SET

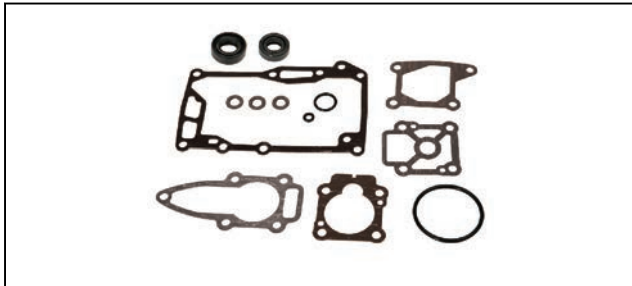

27-8M0082883

LOWER UNIT GASKET SET

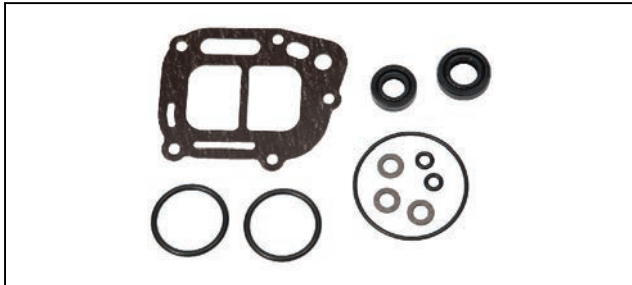

27-8M0082884

SEAL KIT



8M0088080

Gearhousing seal kit.
Fits the Standard gearcase on the Mercury/Mariner F75-115 (2.1L) FourStroke outboard (s/n USA 2B094996 and above).

SEAL KIT



8M0088081

Gearhousing seal kit.
Fits the Command Thrust gearcase on the Mercury/Mariner F75-115 (2.1L) FourStroke outboard (s/n USA 2B094996 and above).

SEAL KIT

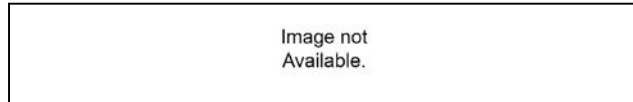

98-8M0135820

15/20 EFI FourStroke outboard, 0R833820 and above.
Quicksilver Branded

LOWER UNIT SEAL KIT APPLICATION CHARTS

Mercury/Mariner Lower Unit Seal Kits

Model	Model Notes	Serial # Range	Lower Unit Seal Kit
2.5		0A855097 and up	27-8M0082878
2.5 FourStroke		JPN 0R131842 and up	27-8M0082881
3		0A855097 and up	27-8M0082878
3.3	NON-SHIFT	0D901217 and up	27-8M0082878
3.3	SHIFT	0D901217 and up	27-8M0082878
3.5	Water Cooled	USA 6202173 and up	N.L.A.
3.5 FourStroke		JPN 0R131842 and up	27-8M0082881
3.6	Water Cooled	USA 5404657 and up	N.L.A.
		BEL 9252831 and up	
		CAN 7145388 and up	
4	1 cylinder.	USA 5595532 - 0A809600	26- 77066A 1
		AUS 8068065 and up	
		BEL 9258281 - 9477829	
		CAN 7143688 and up	
4	1 cylinder.	USA 0A855097 - 0G710612	27-8M0134073
		BEL 9589154 - 0P016999	
4	2 cylinder.	USA 5589202 - 5595531	N.L.A.
		AUS 8065265 - 8068064	
		BEL 9256981 - 9258280	
		CAN 7146488 - 7143687	
4 FourStroke		JPN 0R000001 and up	27-8M0134073
		BEL 0P073456 and up	
4.5	1 cylinder.	USA 4107220 - 0A809600	26- 77066A 1
		AUS 8026540 and up	
		BEL 9072179 - 9477829	
		CAN 7045758 and up	
5	1 cylinder.	USA 0A855097 and up	27-8M0134073
		BEL 9589154 and up	
5 FourStroke		JPN 0R000001 and up	27-8M0134073
		BEL 0P073456 and up	

GEAR CASE COMPONENTS

MERCURY® OUTBOARDS

Model	Model Notes	Serial # Range	Lower Unit Seal Kit
6		USA 0A197112 - 0T800749 BEL 9461526 and up	26- 41365A 3
6 FourStroke		JPN 0R000001 and up BEL 0P073456 and up	27- 8M0134073
7.5	(7.5, 75)	USA 4851693 - 0A197111 AUS 8051350 and up BEL 9181726 - 9461525 CAN 7111898 and up	26- 77066A 1
8		USA 0A197112 and up BEL 9461526 and up	26- 41365A 3
8 FourStroke		USA 0H000058 - 0H017349	26- 41365A 3
8 FourStroke		USA 0G760300 - 0T178499 BEL 0P086824 - 0P325499	26- 41365A 3
8 FourStroke		JPN 0R042475 and up BEL 0P325500 and up	27- 8M0082883
9.8	(9.8, 110)	USA 4839254 - 0A197111 AUS 8050625 and up BEL 9165303 - 9461525 CAN 7111348 and up	26- 77066A 1
9.9		USA 0A197112 and up BEL 9461526 and up	26- 41365A 3
9.9 FourStroke		USA 0H000058 - 0H017349	26- 41365A 3
9.9 FourStroke	Standard Gearcase	USA 0G760300 - 0T979999	26- 41365A 3
9.9 FourStroke	Bigfoot Gearcase	USA 0G760300 - 0T979999 BEL 0P075166 - 0P325499	26- 85090A 2
9.9 FourStroke	Standard Gearcase	JPN 0R042475 and up BEL 0P325500 and up	27- 8M0082883
9.9 FourStroke	BigFoot Gearcase	JPN 0R042475 and up BEL 0P325500 and up	27- 8M0082884
10	(XR 10/Sea Pro 10)	USA 0D038000 and up BEL 9596000 and up	26- 41365A 3
10	Magnum/Marathon	USA 0D038000 and up BEL 9596000 and up	26- 41365A 3
15	(15, 15 Sea Pro/ Marathon)	USA 0B292414 and up BEL 9542620 and up	26- 41365A 3
15	(15XD Sea Pro/ Marathon)	BEL 9927000 and up	26- 85090A 2
15	Super 15	USA 0B238464 and up BEL 9507381 and up CAN 0A730007 and up	26- 85090A 2
15 FourStroke	Standard Gearcase, 323cc	USA 0G590000 - 1B727495 BEL 0P075166 and up	26- 41365A 3
15 FourStroke	Bigfoot Gearcase, 323cc	USA 0G590000 - 1B727495 BEL 0P075166 and up	26- 85090A 2
15 FourStroke		JPN 0R235949 - 0R833819	27- 8M0077448
15 EFI FourStroke		JPN 0R833820 and up	8M0135820
18		USA 5837437 - 6443972 8071973 and up BEL 9308306 - 9415100 CAN 7173723 - 7209532	N.L.A.

Model	Model Notes	Serial # Range	Lower Unit Seal Kit
18	(18XD)	USA 6443973 and up BEL 9378151 and up CAN 7209533 and up	26- 85090A 2
20	(20, 200)	USA 4709593 - 6443972 AUS 8045199 and up BEL 9157230 - 9415100 CAN 7098523 - 7209532	26- 66303A 1
20	(20, 20XD)	USA 6443973 - 0T800749 BEL 9415101 and up CAN 7209533 and up	26- 85090A 2
20 FourStroke		JPN 0R235168 - 0R833819	27- 8M0077448
20 EFI FourStroke		JPN 0R833820 and up	8M0135820
25		USA 5705532 - 6443972 8073158 and up BEL 9315316 - 9415100 CAN 7166928 - 7209532	N.L.A.
25 (25, 25XD)	(25, 25XD)	USA 6416713 and up BEL 9378116 and up CAN 7207858 and up	26- 85090A 2
25	2 cylinder	JPN 0N018456 - 0N187190	27- 95220A 1
25	3 cylinder Lightning	JPN 0E268781 - 0E287999	26- 85090A 2
25 FourStroke		USA 0G590000 - 0T408999 BEL 9973100 - 0P153499	823547A 2
25 FourStroke	Carb Models	USA 0T409000 - 1B226999 BEL 0P153500 - 0P400999	823547A03
25 FourStroke	EFI Models	JPN 0R106999 - 0R515209 BEL 0P401000 and up	27- 8M0089636
30	2 cylinder.	USA 0G053314 - 0T800759 BEL 9854537 - 0P267999	823547A 2
30	2 cylinder	JPN 0N001875 - 0N187190	27- 95220A 1
30 FourStroke	3 cylinder. Standard Gearcase	USA 0G760300 - 0T408999 BEL 0P094500 - 0P153499	823547A 2
30 FourStroke	3 cylinder. Standard Gearcase	USA 0T409000 - 1B226999 BEL 0P153500 - 0P400999	823547A03
30 FourStroke	3 cylinder. Bigfoot Gearcase	USA 0G760300 - 0T408999 BEL 0P094500 - 0P153499	26- 43035A 4
30 FourStroke	3 cylinder. Bigfoot Gearcase	USA 0T409000 - 1B226999 BEL 0P153500 - 0P400999	26- 43035A05
30 FourStroke	EFI Models	JPN 0R106999 - 0R515209 BEL 0P401000 and up	27- 8M0089636
35	2 cylinder	USA 6445653 and up BEL 9384476 and up CAN 7209608 and up	26- 79831A 1
40	2 cylinder	USA 4860103 - 6445652 AUS 8052125 and up BEL 9184451 - 9415100 CAN 7112423 - 7209608	26- 79831A 1
40	2 cylinder	USA 0G053314 - 0T800749 BEL 9854537 - 0P267999	823547A 2
40	3 cylinder	USA 0G531301 and up BEL 9973100 and up	823547A 2

Not all parts listed are available for the European, C.I.S., Africa and Middle East Markets.
For more information, please contact your local Mercury, Mariner, MerCruiser or Quicksilver Office.

GEAR CASE COMPONENTS

MERCURY® OUTBOARDS

Model	Model Notes	Serial # Range	Lower Unit Seal Kit
40	4 cylinder	USA 0C159200 - 0G589999 BEL 9570790 - 9973099	26- 79831A 1
40 FourStroke	3 cylinder. Standard Gearcase	USA 0G760300 - 0T408999 BEL 0P094500 - 0P153499	823547A 2
40 FourStroke	3 cylinder. Standard Gearcase	USA 0T409000 - 1B226999 BEL 0P153500 - 0P400999	823547A03
40 FourStroke	3 cylinder. Bigfoot Gearcase	USA 0G760300 - 0T408999 BEL 0P094500 - 0P153499	26- 43035A 4
40 FourStroke	3 cylinder. Short Shaft	USA 1B227000 - 1B344398 BEL 0P153500 - 0P515896 CHN 1C000001 - 1C049738	823547A03
40 FourStroke	3 cylinder. Long Shaft	CHN 1C000001 - 1C049738 BEL 0P401000 - 0P515896	26- 814669A 2
40 FourStroke	3 cylinder	CHN 1C049739 and up	26- 814669A 2
40 FourStroke	4 cylinder Carb, Standard, Vertical Shift	USA 0G231123 - 0T598999 BEL 9944807 - 0P106999	823547A 2
40 FourStroke	4 cylinder Carb, Standard, Rotary Shift	USA 0T178500 - 0T598999 BEL 0P094500 - 0P206999	26- 814669A 2
40 FourStroke	4 cylinder Carb, Bigfoot	USA 0G231123 - 0T598999 BEL 9944807 - 0P206999	26- 43035A 4
40 FourStroke	4 cylinder EFI, Standard	USA 0T409000 - 1B344306 BEL 0P153500 and up CHN 1C000001 and up	26- 814669A 2
40 FourStroke	4 cylinder EFI, Bigfoot	USA 0T409000 - 1B344306 BEL 0P153500 and up CHN 1C000001 - 1C033810	26- 43035A05
40 FourStroke	4 cylinder EFI, Bigfoot	CHN 1C033811 - 1C050251	26- 43035A 4
40 FourStroke	4 cylinder EFI, Bigfoot	CHN 1C050252 and up	26- 43035A05
45	4 cylinder.	USA 5531630 and up AUS 8063985 and up BEL 9248006 and up CAN 7143688 and up	26- 79831A 1
45 FourStroke	4 cylinder. Standard Gearcase	USA 0G231123 - 0T178499 BEL 9944807 - 0P094499	823547A 2
45 FourStroke	4 cylinder. Bigfoot Gearcase	USA 0G231123 - 0T178499 BEL 9944807 - 0P094499	26- 43035A 4
50	4 cylinder.	USA 4357640 and up CAN 7068998 and up AUS 8030090 and up BEL 9107214 and up	26- 79831A 1
50	3 cylinder.	USA 6428681 - 0D000749 BEL 9385911 - 9683054 CAN 7208333 and up	26- 79831A 1
50	3 cylinder.	USA 0D000750 - 0G589999 BEL 9683055 - 9973099	26- 814669A 2
50	3 cylinder.	USA 0G590000 and up BEL 9973100 and up	823547A 2
50 FourStroke	4 cylinder Carb, Standard Gearcase	USA 0G231123 - 0T178499 BEL 9944807 - 0P016999	823547A 2

Model	Model Notes	Serial # Range	Lower Unit Seal Kit
50 FourStroke	4 cylinder Carb, Standard Gearcase	USA 0T178500 - 0T598999 BEL 0P094500 - 0P206999	26- 814669A 2
50 FourStroke	4 cylinder Carb, Bigfoot Gearcase	USA 0G231123 - 0T598999 BEL 9944807 - 0P206999	26- 43035A 4
50 FourStroke	4 cylinder EFI, Standard Gearcase	USA 0T409000 - 1B344306 BEL 0P153500 and up CHN 1C000001 and up	26- 814669A 2
50 FourStroke	4 cylinder EFI, Bigfoot Gearcase	USA 0T409000 - 1B344306 BEL 0P153500 - 0P400999 BEL 0P515897 and up CHN 1C000001 - 1C033810 CHN 1C050252 and up	26- 43035A05
50 FourStroke	4 cylinder EFI, Bigfoot Gearcase	CHN 1C033811 - 1C050251	26- 43035A 4
55	3 cylinder.	USA 0D000750 and up BEL 9683055 and up	26- 814669A 2
60	3 cylinder.	USA 6428681 - 0D000749 BEL 9385911 - 9683054 CAN 7208333 and up	26- 79831A 1
60	3 cylinder. Standard Gearcase	USA 0D000750 and up BEL 9683055 and up	26- 814669A 2
60	3 cylinder. Bigfoot Gearcase	USA 0D000750 and up BEL 9683055 and up	26- 43035A 4
60 FourStroke	4 cylinder Carb, Standard Gearcase	USA 0T178500 - 0T598999 BEL 0P094500 - 0P206999	26- 814669A 2
60 FourStroke	4 cylinder Carb, Bigfoot Gearcase	USA 0T178500 - 0T598999 BEL 0P094500 - 0P206999	26- 43035A 4
60 FourStroke	4 cylinder EFI, Standard Gearcase	USA 0T409000 - 1B344306 BEL 0P153500 and up CHN 1C000001 and up	26- 814669A 2
60 FourStroke	4 cylinder EFI, Bigfoot Gearcase	USA 0T409000 - 1B344306 BEL 0P153500 - 0P400999 BEL 0P515897 and up CHN 1C000001 - 1C033810 CHN 1C050252 and up	26- 43035A05
60 FourStroke	4 cylinder EFI, Bigfoot Gearcase	CHN 1C033811 - 1C050251	26- 43035A 4
70	3 cylinder.	USA 4571652 - 0A996141 AUS 8042350 and up BEL 9135825 - 9385910 CAN 7087823 - 7208332	26- 79831A 1
70	3 cylinder.	USA 0A996142 and up BEL 9483121 and up	26- 43035A 4
75	3 cylinder.	USA 0C222000 and up BEL 9589039 and up	26- 43035A 4
75 Optimax	3 cylinder.	USA 0T980000 and up	26- 43035A 4

GEAR CASE COMPONENTS

Model	Model Notes	Serial # Range	Lower Unit Seal Kit
75	4 cylinder.	USA 6432901 - 0B122929	26- 55682A 1
		BEL 9393856 - 9469199	
		CAN 7208573 - 0A721307	
75 FourStroke	Carb and EFI	USA 0G960500 - 2B094995	26- 43035A 4
		BEL 0P094500 and up	
75/80 FourStroke	2.1L, Standard gearcase	USA 2B094996 and up	8M0088080
75/80 FourStroke	2.1L, Command Thrust gearcase	USA 2B094996 and up	8M0088081
80	4 cylinder.	USA 4831999 - 6432900	26- 55682A 1
		AUS 8050200 and up	
		BEL 9177626 - 9393855	
		CAN 7110998 - 7208572	
80	3 cylinder.	USA 0A996142 - 0C221999	26- 43035A 4
		BEL 9483121 - 9589038	
90	6 cylinder.	USA 4845301 - 0A996141	26- 55682A 1
		CAN 7111698 and up	
		AUS 8060545 and up	
90	3 cylinder.	USA 0A996142 and up	26- 43035A 4
		BEL 9483121 and up	
90 Optimax	3 cylinder.	USA 0T980000 and up	26- 43035A 4
90 FourStroke	Carb and EFI	USA 0G960500 - 2B094995	26- 43035A 4
		BEL 0P094500 and up	
90/100 FourStroke	2.1L, Standard gearcase	USA 2B094996 and up	8M0088080
90/100 FourStroke	2.1L, Command Thrust gearcase	USA 2B094996 and up	8M0088081
100	4 cylinder.	USA 0B209468 - 0G960499	26- 43035A 4
		BEL 9523034 - 0P058999	
115	6 cylinder.	USA 4855153 and up	26- 55682A 1
		AUS 8051950 and up	
		CAN 7112248 and up	
115	4 cylinder.	USA 0C100000 and up	26- 43035A 4
		BEL 9559771 and up	
115 Optimax	3 cylinder.	USA 0T801000 and up	26- 43035A 4
115 Pro XS		USA 1B751825 and up	26- 43035A 4
115 FourStroke	EFI	USA 0T178500 - 2B094995	26- 43035A 4
115 FourStroke	2.1L, Standard gearcase	USA 2B094996 and up	8M0088080
115 FourStroke	2.1L, Command Thrust gearcase	USA 2B094996 and up	8M0088081
125	4 cylinder.	USA 0D283222 and up	26- 43035A 4
		BEL 9793577 and up	
125 Optimax	3 cylinder	USA 1B736885 and up	26- 43035A 4
140	6 cylinder. (140, 1400)	USA 4865678 and up	26- 55682A 1
		AUS 8052650 and up	
		CAN 7112773 and up	
V-135		USA 0A904646 - 0C239552	26- 89238A 2
V-135		USA 0C239553 and up	26- 89238A 2
V-135 Optimax	DFI	USA 0G590000 and up	26- 89238A 2
135 Verado		USA 1B227000 and up	26- 830749A01
V-150	(150, 1500)	USA 4868998 - 0A904645	26- 55682A 1
V-150	Carb	USA 0A904646 and up	26- 89238A 2
V-150	(XR4/Magnum II)	USA 0B242885 - 0C239552	26- 89238A 2
V-150	(XR4)	USA 0C239553 - 0D081999	26- 89238A 2
V-150	(XR6/Magnum III)	USA 0D082000 and up	26- 89238A 2

Model	Model Notes	Serial # Range	Lower Unit Seal Kit
V-150	EFI	USA 0D082000 and up	26- 89238A 2
V-150 Optimax	DFI & Pro XS	USA 0G590000 and up	26- 89238A 2
150 FourStroke	EFI	USA 1B905505 and up	8M0057716
150 Verado		USA 1B227000 and up	26-830749A01
V-175	(175, 1750)	USA 4301235 - 6618750	26- 55682A 1
		AUS 8058870 and up	
V-175	Carb, EFI	USA 6618751 and up	26- 89238A 2
V-175 Optimax	DFI	USA 0T178500 and up	26- 89238A 2
V-175 Pro XS		USA 1B516339 and up	26- 89238A 2
175 Verado		USA 1B227000 and up	26-830749A01
V-200	(200, 2000)	USA 4839034 - 6625220	26- 55682A 1
		AUS 8061595 and up	
V-200	(2.5L) Carb, EFI	USA 6625221 and up	26- 89238A 2
V-200	(3.0L) EFI	USA 0T801000 and up	26-816575A 4
V-200 Optimax	(3.0L) DFI, With C-2 Casting	USA 0G386496 - 0G437999	26-816575A 5
V-200 Optimax	(3.0L) DFI, With C-3 Casting	USA 0G386496 - 0G437999	26-816575A 4
V-200 Optimax	(3.0L) DFI	USA 0G438000 - 1B504988	26-816575A 4
V-200 Optimax	(3.0L) DFI	USA 1B504989 and up	26-830749A01
V-200 Pro XS	(3.0L) DFI	USA 1B504989 and up	26-830749A01
200 Verado	4 cylinder, 4.8 inch Torpedo	USA 0T980000 and up	26-830749A01
200 Verado	6 cylinder, 4.8 inch Torpedo	USA 0T980000 and up	26-830749A01
	6 cylinder, 5.44 inch Torpedo		8M0065064
V-220		USA 0B117316 - 0C100860	26- 89238A 2
V-225		USA 5628028 - 6042945	26- 55682A 1
V-225	(3.0L)(With C-2 Casting)	USA 0D280813 - 0G437999	26-816575A 5
V-225	(3.0L)(With C-3 Casting)	USA 0D280813 - 0G437999	26-816575A 4
V-225	(3.0L)	USA 0G438000 and up	26-816575A 4
V-225	(3.0L) EFI, With C-2 Casting	USA 0G129222 - 0G437999	26-816575A 5
V-225	(3.0L) EFI, With C-3 Casting	USA 0G129222 - 0G437999	26-816575A 4
V-225	(3.0L) EFI	USA 0G438000 - 1B504988	26-816575A 4
V-225 Optimax	(3.0L) DFI	USA 0G590000 - 1B504988	26-816575A 4
V-225 Optimax	(3.0L) DFI	USA 1B504989 and up	26-830749A01
V-225 Pro XS	w/ Torque Master	USA 1B104549 - 1B752546	26-816575A 6
V-225 Pro XS		USA 1B752547 and up	26-830749A01
V-225 FourStroke	EFI	USA 0T653945 - 0T800999	N.L.A.
V-225 FourStroke	EFI	USA 0T801000 and up	N.L.A.
225 Verado	4.8 inch Torpedo	USA 0T980000 and up	26-830749A01
	5.44 inch Torpedo		8M0065064
V-250	(3.0L) EFI, With C-2 Casting	USA 0G129222 - 0G437999	26-816575A 5
V-250	(3.0L) EFI, With C-3 Casting	USA 0G129222 - 0G437999	26-816575A 4
V-250	(3.0L) EFI	USA 0G438000 - 1B504988	26-816575A 4
V-250 Pro XS	w/ Torque Master	USA 1B426561 - 1B752546	26-816575A 6
V-250 Pro XS		USA 1B752547 and up	26-830749A01
250 Verado	4.8 inch Torpedo	USA 0T980000 and up	26-830749A01
	5.44 inch Torpedo		8M0065064

Not all parts listed are available for the European, C.I.S., Africa and Middle East Markets.
For more information, please contact your local Mercury, Mariner, MerCruiser or Quicksilver Office.

GEAR CASE COMPONENTS

MERCURY® OUTBOARDS

Model	Model Notes	Serial # Range	Lower Unit Seal Kit
275 Verado	4.8 inch Torpedo	USA 0T980000 and up	26-830749A01
	5.44 inch Torpedo		26-8M0065064
300 Verado	4.8 inch Torpedo	USA 1B517434 and up	26-830749A01
	5.44 inch Torpedo		8M0065064
350Sci Verado		USA 1B716557 - 2B143542	26-830749A02

TABLE OF CONTENTS

Mercury® MerCruiser® Ignition	149	Mercury® MerCruiser® External Engine	207
Distributor Cap and Rotor Kits	152	Engine Couplers	208
Distributor Caps	153	Serpentine Belts	207
ICM Modules	166	V-Belts	207
Ignition Coil, Wires and Spark Plug Chart	160	Mercury® MerCruiser® Internal Engine	211
Ignition Coils	156	Gasket Sets - Engine Overhaul	213
Ignition Kits and Components Chart	155	Head Gaskets	217
Ignition Modules	166	Oil Pump Pick-Up Tubes	212
Points	149	Oil Pumps	211
Rotors	150	Mercury® MerCruiser® Transom	218
Spark Plug Boot Kit	160	Drive Installation Gasket Kits	220
Spark Plug Wire Kits	157	Engine Mounting Hardware	218
Tune Up Kits	149	Gimbal Ring Kits	218
Mercury® MerCruiser® Electrical System	167	Shift Cable Bellows	221
Electrical Harness Repair Kits	168	Shift Cable Kits	219
Starter Slave Solenoids	167	Shift Cables	219
Mercury® MerCruiser® Fuel System	171	Sterndrive Installation Hardware	219
Carburetor and Repair Parts Chart	173	Transom Gasket and Seal Chart	221
Carburetor Gasket Kits	172	Transom Seal Repair Kits	221
Carburetor Repair Kits	171	Mercury® MerCruiser® Drive Systems	223
Fuel Pumps	178	Gear Chart - Driveshaft Housing	227
MerCruiser Fuel Filters - Carburetor	172	Gear Chart - Gear Housing	236
MerCruiser Fuel Filters - Fuel Pump	181	Gear Repair Kits - Driveshaft Housing	223
Mercury® MerCruiser® Cooling System	182	Gear Repair Kits - Gear Housing	232
Hoses - Water	187	Gears - Driveshaft Housing	226
MerCruiser Thermostat Kits	186	Gear Sets - Driveshaft Housing	224
MerCruiser Water Pump Repair Kits - Drive	184	Gears - Gear Housing	233
MerCruiser Water Pump Repair Kits - Sea Water	182	Seal & Bearing Kits - Gear Housing	230
Oil Coolers	202	Seal Chart - Sterndrive	231
Water Pump Repair Kits Chart	185	Seal Kits - Driveshaft Housing	229
Mercury® MerCruiser® Exhaust System	206	Seal Kits - Gear Housing	230
Exhaust Water Shutters	206	U-Joint and Components	223
		Mercury® MerCruiser® Power Trim	238
		Power Trim Cylinder Hoses	244
		Power Trim Pumps and Components	238

TABLE OF CONTENTS - MERCURY® MERCUISER®

Trim Cylinder Anchor Pin Chart	243
Trim Cylinder Anchor Pins & Kits	242
Trim Cylinder Chart	241
Trim Cylinder O-Ring Kits	240
Trim Cylinder Repair Kits	239

MERCURY® MERCUISER® IGNITION

TUNE UP KITS

TUNE-UP KIT



34235T 1

Fits GM in-line 4 & 6 cylinder engines with conventional Delco ignition. See application chart for specific models.
Priced individually, sold @ multiples of 2
Mercury Branded, Clamshell Package Point of Sale Packaged.

34235Q 1

Fits GM in-line 4 & 6 cylinder engines with conventional Delco ignition.
Priced individually, sold @ multiples of 2
Quicksilver Branded, Clamshell Package Point of Sale Packaged.

TUNE-UP KIT



392- 6324Q 1

Fits MerCruiser 3.0L, 3.7L, 3.8L (V-6), 5.7L Tow Sports and Ford 233 (V-8) with Prestolite ignition with screw down cap.
Priced individually, sold @ multiples of 2
Quicksilver Branded, Clamshell Package Point of Sale Packaged.

TUNE-UP KIT



391- 5090T 1

Fits Ford & GM V-8 engines with Mallory ignition. See application chart for specific models.
Priced individually, sold @ multiples of 2
Mercury Branded, Clamshell Package Point of Sale Packaged.

391- 5090Q 1

Fits Ford & GM V-8 engines with Mallory ignition.
Priced individually, sold @ multiples of 2
Quicksilver Branded, Clamshell Package Point of Sale Packaged.

TUNE-UP KIT



392- 6325T 1

Fits MerCruiser Ford 888 (s/n 3108723 and above) and Ford 233 (s/n 4173000 and above) with Prestolite ignitions with clip down cap. See application chart for specific models.
Priced individually, sold @ multiples of 2
Mercury Branded, Clamshell Package Point of Sale Packaged.

392- 6325Q 1

Fits MerCruiser Ford 888 (s/n 3108723 and above) and Ford 233 (s/n 4173000 and above) with Prestolite ignitions with clip down cap.
Priced individually, sold @ multiples of 2
Quicksilver Branded, Clamshell Package Point of Sale Packaged.

POINTS

POINTS

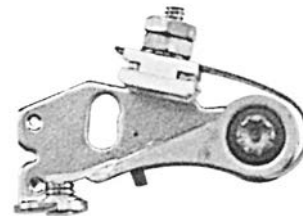

34235T

Fits GM 4 & 6 cyl. engines with Delco conventional ignition. See application chart for specific models.
Priced individually, sold @ multiples of 2

34235T

Fits GM 4 & 6 cyl. engines with Delco conventional ignition. See application chart for specific models.
Priced individually, sold @ multiples of 2

POINTS



8M6001219

Fits Ford & GM 4, 6 & 8 cyl. Engines with Prestolite conventional ignition.

POINTS



8M6001221

Fits Ford (302 cid) with Autolite ignition. See application chart for specific models.

POINTS



8M6001250

Fits GM & Ford V-8 engines with Mallory conventional ignition.

POINTS



87-71831

Fits GM & Ford V-8 engines with Mercury ignition. See application chart for specific models.

ROTORS

ROTOR



8M6001251

Fits GM 4 & 6 cyl. engines with Delco conventional ignition.

ROTOR



392-9089T

Fits Ford & GM 4, 6 & 8 cyl. engines with Prestolite conventional ignition.

ROTOR



8M6001254

Use with 811635T 3 Distributor Cap
Fits GM 4 cyl. engines with Delco EST ignition.

ROTOR



13524A 6

Fits GM V-6 engines with Thunderbolt IV & V HEI ignition. See application chart for specific models.

ROTOR



8M0062084

Use with 850484T 2 Distributor Cap
Fits GM V-6 engines with Delco HEI ignition.

ROTOR



13524T 1

Fits GM V-8 engines with Thunderbolt IV & V ignition.

ROTOR



13524T12

Fits Black Scorpion Tow Sports (s/n 0M391600 thru 2A460164) and MX 6.2L Black Scorpion Tow Sports (s/n 0M391750 thru 2A460138)

ROTOR



879288T34

Fits Scorpion 350 & 377 Tow Sports EC engines(s/n 0W698433 thru 2A460148).

ROTOR



65864

Fits Ford & GM V-8 engines with Autolite & Mercury ignition. See application chart for specific models.

ROTOR

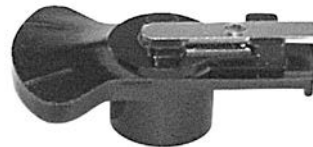

8M6001224

Fits Ford & GM V-8 engines with Mallory conventional ignition.

ROTOR



8M6001253

Use with 808483T 3 Distributor Cap
Fits GM V-8 engines with Delco HEI ignition.

ROTOR



8M6001252

Use with 808483T 3 Distributor Cap
Fits GM V-8 engines with Delco HEI ignition (1998 and newer), except MPI eng's w/ ECM 555.

ROTOR



8M6001222

Fits 2001 and newer MCM/MIE 4.3L, 5.0L, 5.7L & 6.2L MPI engines with ECM 555 (s/n 0M300000 and up).

DISTRIBUTOR CAP AND ROTOR KITS

CAP AND ROTOR KIT



811635K 2

Fits GM 4 cyl. engines w/ Delco EST ignition
Mercury Branded, Clamshell Package Point of Sale Packaged.

811635Q 2

Fits GM 4 cyl. engines w/ Delco EST ignition
Quicksilver Branded, Clamshell Package Point of Sale Packaged.

CAP AND ROTOR KIT



815407T 5

Fits GM V-6 engines with Thunderbolt IV & V HEI ignitions.
Mercury Branded, Clamshell Package Point of Sale Packaged.

815407Q 5

Fits GM V-6 engines with Thunderbolt IV & V HEI ignitions.
Quicksilver Branded, Clamshell Package Point of Sale Packaged.

CAP AND ROTOR KIT



850484T 3

Fits GM V-6 engines w/ Delco HEI ignition.

CAP AND ROTOR KIT



898253T28

Fits MCM 4.3L MPI

CAP AND ROTOR KIT



393- 4988T 1

Fits Ford & GM V-8 engines w/ Autolite & Mercury ignitions

CAP AND ROTOR KIT

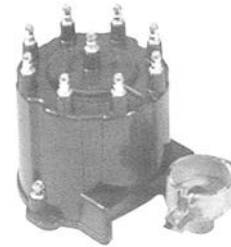

808483K 1

Fits 1997 & older GM V-8 engines w/ Delco HEI ignition
Mercury Branded, Clamshell Package Point of Sale Packaged.

808483Q 1

Fits 1997 & older GM V-8 engines w/ Delco HEI ignition
Quicksilver Branded, Clamshell Package Point of Sale Packaged.

CAP AND ROTOR KIT



808483K 2

Fits 1998-2015 GM V-8 engines w/ Delco HEI ignition
Mercury Branded, Clamshell Package Point of Sale Packaged.

808483Q 2

Fits 1998-2015 GM V-8 engines w/ Delco HEI ignition
Quicksilver Branded, Clamshell Package Point of Sale Packaged.

MERCURY® MERCURISER®

CAP AND ROTOR KIT



805759T 3

Fits GM V-8 engines with Thunderbolt IV & V HEI ignitions
Mercury Branded, Clamshell Package Point of Sale Packaged.

805759Q 3

Fits GM V-8 engines with Thunderbolt IV & V HEI ignitions
Quicksilver Branded, Clamshell Package Point of Sale Packaged.

CAP AND ROTOR KIT



805759T05

Fits Black Scorpion Tow Sports (s/n 0M391600 thru 2A460164) and MX 6.2L Black Scorpion Tow Sports (s/n 0M391750 thru 2A460138)

CAP AND ROTOR KIT



8M0061335

Fits 2001-2015 MCM/MIE 5.0L, 5.7L & 6.2L MPI engines with ECM 555 (s/n 0M300000 thru 2A455878)

DISTRIBUTOR CAPS

DISTRIBUTOR CAP



393- 9459Q 1

Fits GM 4 cyl. engines with Delco conventional ignition
Quicksilver Branded, Clamshell Package Point of Sale Packaged.

DISTRIBUTOR CAP



8M0082721

Fits GM 4 cyl. engines w/ Prestolite ignition

DISTRIBUTOR CAP



811635T 3

Fits GM 4 cyl. engines w/ Delco EST ignition

DISTRIBUTOR CAP



33765T

Fits GM in-line 6 cyl. engines w/ Delco conventional ignition.

DISTRIBUTOR CAP



815407A 2

Fits GM V-6 engines with Thunderbolt IV & V HEI ignitions

815407Q02

Fits GM V-6 engines with Thunderbolt IV & V HEI ignitions
Quicksilver Branded, Clamshell Package Point of Sale Packaged.

DISTRIBUTOR CAP



850484T 2

Fits GM V-6 engines w/ Delco HEI ignition

DISTRIBUTOR CAP



898253T23

Fits MCM 4.3L MPI

DISTRIBUTOR CAP



391- 5075Q 1

Fits Ford & GM V-8 engines w/ Mallory ignition
Quicksilver Branded, Clamshell Package Point of Sale Packaged.

DISTRIBUTOR CAP



392- 9766Q 1

Fits Ford & GM V-8 engines with Prestolite conventional ignition (screw hold-down cap)
Quicksilver Branded, Clamshell Package Point of Sale Packaged.

DISTRIBUTOR CAP

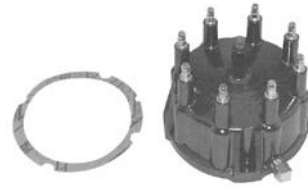

805759T 1

Fits GM V-8 engines with Thunderbolt IV & V HEI ignitions

805759Q01

Fits GM V-8 engines with Thunderbolt IV & V HEI ignitions
Quicksilver Branded, Clamshell Package Point of Sale Packaged.

DISTRIBUTOR CAP



808483T 3

Fits GM V-8 engines w/ Delco HEI ignition, except MPI engines w/ ECM 555

DISTRIBUTOR CAP



8M6001106

Fits 2001-2015 MCM/MIE 5.0L, 5.7L & 6.2L MPI engines with ECM 555 (s/n 0M300000 thri 2A455878)

MERCURY® MERCRUISER®

IGNITION KITS AND COMPONENTS CHART

Ignition Tune-up Kits

Model	CID/ #Cyl	Type of Ignition	Year Range	Serial # Range	Tune-up Kit	Points	Rotor	Condenser	Rotor/Cap Kit	Distributor Cap
2.5L	153/ L4	Delco	1963 - 1989	1537370 - 0C853255	34235T 1	34235T	8M6001251	8M6001218	N/A	393- 9459Q 1
2.5L	153/ L4	Prestolite	1963 - 1989	1537370 - 0C853255	392- 6324T 1	8M6001219	392- 9089T	8M6001249	N/A	8M0082721
3.0L	181/ L4	Delco	1968 - 1989	2508261 - 0C856558	34235T 1	34235T	8M6001251	8M6001218	N/A	393- 9459Q 1
3.0L	181/ L4	Prestolite	1968 - 1991	0C856559 - 0D504541	392- 6324T 1	8M6001219	392- 9089T	8M6001249	N/A	8M0082721
3.0L	181/ L4	Delco Digital	1990 - 1991	0C856559 - 0D504541	N/A	N/A	N/A	N/A	N/A	N/A
3.0L	181/ L4	Delco EST	1991 - 2016	0D504542 - 2A506300	N/A	N/A	8M6001254	N/A	811635K 2	811635T 3
3.7L	224/ L4	Delco	1976 - 1984	4208730 and up	34235T 1	34235T	8M6001251	8M6001218	N/A	393- 9459Q 1
3.7L	224/ L4	Prestolite	1976 - 1989	4208730 and up	392- 6324T 1	8M6001219	392- 9089T	8M6001249	N/A	8M0082721
3.1L	194/ L6	Delco	1963	1538930 - 1725960	34235T 1	34235T	8M6001251	8M6001218	N/A	33765T
3.8L	230/ L6	Delco	1964 - 1966	1666495 - 2048046	34235T 1	34235T	8M6001251	8M6001218	N/A	33765T
4.0L	250/ L6	Delco	1967 - 1981	2048022 - 5813433	34235T 1	34235T	8M6001251	8M6001218	N/A	33765T
4.0L	250/ L6	Prestolite	1967 - 1981	2048022 - 5813433	392- 6324T 1	8M6001219	392- 9089T	8M6001249	N/A	N.L.A.
4.8L	292/ L6	Delco	1969	2453769 - 2712072	34235T 1	34235T	8M6001251	8M6001218	N/A	33765T
3.8L	229/ V-6	Prestolite	1983 - 1984	6330183 - 6919655	392- 6324T 1	8M6001219	392- 9089T	8M6001249	N/A	N.L.A.
4.3L	262/ V-6	Thunderbolt IV & V	1985 - 2015	6919656 - 2A454127	N/A	N/A	13524A 6	N/A	815407T 5	815407A 2
4.3L	262/ V-6	Delco - HEI	1996 - 2001	0F803800 - 0M299999	N/A	N/A	8M0062084	N/A	850484T 3	850484T 2
4.3L	262/ V-6	Delco - HEI	2002 - 2016	0M300000 - 2A528897	N/A	N/A	8M6001222	N/A	898253T28	898253T23
5.0L (Ford)	302/ V-8	Autolite	1970 - 1977	2781153 - 4887829	N.L.A.	8M6001221	65864	N.L.A.	N/A	N.L.A.
5.0L (Ford)	302/ V-8	Mallory	1970 - 1977	2781153 - 4887829	391- 5090T 1	8M6001250	8M6001224	8M6001217	N/A	391- 5075Q 1
5.0L (Ford)	302/ V-8	Mercury	1971 - 1977	3108723 - 4887829	N.L.A.	87- 71831	65864	N.L.A.	N/A	N.L.A.
5.0L (Ford)	302/ V-8	Prestolite	1971 - 1977	3108723 - 4887829	392- 6325T 1	8M6001219	N.L.A.	8M6001249	N/A	N.L.A.
4.6L	283/ V-8	Delco	1963 - 1964	1564539 - 1730903	N.L.A.	N.L.A.	N.L.A.	N.L.A.	N/A	N.L.A.
5.0L	305/ V-8	Mallory	1977 - 1982	4765100 - 6218461	391- 5090T 1	8M6001250	8M6001224	8M6001217	N/A	391- 5075Q 1
5.0L	305/ V-8	Thunderbolt IV & V	1981 - 2009	5907058 - 1A607561	N/A	N/A	13524T 1	N/A	805759T 3	805759T 1
5.0L	305/ V-8	Delco - HEI	1998 - 2001	0L012052 - 0M299999	N/A	N/A	8M6001253	N/A	808483K 1	808483T 3
5.0L	305/ V-8	Delco - HEI	2002 - 2014	0M300000 - 2A445009	N/A	N/A	8M6001222	N/A	8M0061335	8M6001106
5.4L	327/ V-8	Delco	1963 - 1969	1539620 - 2694014	N.L.A.	N.L.A.	N.L.A.	N.L.A.	N/A	N.L.A.
5.4L	327/ V-8	Thunderbolt	1968	2278647 - 2694014	N/A	N/A	65864	N/A	393- 4988T 1	N.L.A.
5.7L	350/ V-8	Thunderbolt	1969 - 1972	2851074 - 3385720	N/A	N/A	65864	N/A	393- 4988T 1	N.L.A.
5.7L	350/ V-8	Mercury	1975 - 1976	3258728 - 4501254	N.L.A.	87- 71831	65864	N.L.A.	N/A	N.L.A.
5.7L	350/ V-8	Mallory	1976 - 1995	4498701 - 0F775199	391- 5090T 1	8M6001250	8M6001224	8M6001217	N/A	391- 5075Q 1
5.7L	350/ V-8	Thunderbolt IV & V	1981 - 2009	5907058 - 1A600136	N/A	N/A	13524T 1	N/A	805759T 3	805759T 1
5.7L	350/ V-8	Prestolite	1985 - 1996	0A338553 - 0F775199	392- 6324T 1	8M6001219	392- 9089T	8M6001249	N/A	392- 9766Q 1
5.7L	350/ V-8	Delco - HEI	1994 - 2001	0F215561 - 0M299999	N/A	N/A	8M6001253	N/A	808483K 1	808483T 3
5.7L	350/ V-8	Delco - HEI	2002 - 2015	0M300000 - 2A455977	N/A	N/A	8M6001222	N/A	8M0061335	8M6001106
5.7L Scorpion	350/ V-8	Mercury - HEI	2003 - 2015	0M391600 - 2A460164	N/A	N/A	13524T12	N/A	805759T05	805759T 1
5.8L (Ford)	351/ V-8	Mallory	1973 - 1980	3258728 - 5907057	391- 5090T 1	8M6001250	8M6001224	8M6001217	N/A	391- 5075Q 1
5.8L (Ford)	351/ V-8	Mercury	1973 - 1980	3258728 - 5907057	N.L.A.	87- 71831	65864	N.L.A.	N/A	N.L.A.
5.8L (Ford)	351/ V-8	Prestolite(1)	1975 - 1977	4173000 - 4902304	392- 6325T 1	8M6001219	N.L.A.	8M6001249	N/A	N.L.A.

MERCURY® MERCUISER®

MERCURY® MERCURISER® IGNITION

Model	CID/ #Cyl	Type of Ignition	Year Range	Serial # Range	Tune-up Kit	Points	Rotor	Condenser	Rotor/Cap Kit	Distributor Cap
5.8L (Ford)	351/ V-8	Prestolite(2)	1975 - 1977	4173000 - 4902304	392- 6324T 1	8M6001219	392- 9089T	8M6001249	N/A	392- 9766Q 1
6.2L	377/ V-8	Thunderbolt V	2000 - 2001	0L680003 - 0M299999	N/A	N/A	13524T 1	N/A	13524T 1	805759T 1
6.2L	377/ V-8	Delco - HEI	2002 - 2015	0M300000 - 2A455858	N/A	N/A	8M6001222	N/A	8M0061335	8M6001106
6.2L Scorpion	377/ V-8	Delco - HEI	1997 - 2003	0K000656 - 0M391599	N/A	N/A	8M6001253	N/A	808483K 1	808483T 3
6.2L Scorpion	377/ V-8	Mercury - HEI	2003 - 2015	0M391600 - 2A460138	N/A	N/A	13524T12	N/A	805759T05	805759T 1
7.0L	427/ V-8	Thunderbolt	1969 - 1974	2278747 and up	N/A	N/A	65864	N/A	393- 4988T 1	N.L.A.
7.4L	454/ V-8	Mallory	1977 - 1986	4623115 - 0B485220	391- 5090T 1	8M6001250	8M6001224	8M6001217	N/A	391- 5075Q 1
7.4L	454/ V-8	Thunderbolt	1974 - 1981	3780450 - 6083144	N/A	N/A	65864	N/A	393- 4988T 1	N.L.A.
7.4L	454/ V-8	Holley	1978 - 1986	4883520 - 0B485220	N.L.A.	87- 71831	65864	N.L.A.	N/A	N.L.A.
7.4L	454/ V-8	Thunderbolt IV & V	1981 - 1999	5889914 - 0L415623	N/A	N/A	13524T 1	N/A	805759T 3	805759T 1
7.4L	454/ V-8	Delco - HEI	1994 - 1998	0F115700 - 0L085009	N/A	N/A	8M6001253	N/A	808483K 1	808483T 3
7.4L	454/ V-8	Delco - HEI	1998 - 2001	0L085010 - 0M024999	N/A	N/A	8M6001252	N/A	808483K 2	808483T 3
7.9L	482/ V-8	Thunderbolt	1969 - 1970	2781129 - 2825059	N/A	N/A	65864	N/A	393- 4988T 1	N.L.A.
7.9L	482/ V-8	Mallory	1983 - 1986	6180970 - 6181046	391- 5090T 1	8M6001250	8M6001224	8M6001217	N/A	391- 5075Q 1
7.9L	482/ V-8	Holley	1983 - 1986	6180970 - 6181046	N.L.A.	87- 71831	65864	N.L.A.	N/A	N.L.A.
8.2L	502/ V-8	Thunderbolt IV & V	1990 - 1999	0C878221 - 0L601036	N/A	N/A	13524T 1	N/A	805759T 3	805759T 1
8.2L	502/ V-8	Delco - HEI	1993 - 1998	0D840650 - 0L085000	N/A	N/A	8M6001253	N/A	808483K 1	808483T 3
8.2L	502/ V-8	Delco - HEI	1998 - 2005	0L085001 - 0M950526	N/A	N/A	8M6001252	N/A	808483K 2	808483T 3
8.8L	540/ V-8	Thunderbolt IV & V	1986 - 2001	0A677429 - 0M050281	N/A	N/A	13524T 1	N/A	805759T 3	805759T 1

(1) With clip down distributor cap

(2) With screw down distributor cap

MERCURY® MERCURISER®

IGNITION COILS

IGNITION COIL



898253T24

Uses External Resistor

Fits MCM 4 cyl., V-6 & V-8 engines with conventional ignition and some outboard applications.

IGNITION COIL



898253T27

Fits 4 cyl., GM V-6 & V-8 engines w/ Delco HEI ignition

IGNITION COIL



300 8M0079202

Fits GM V-6 & V-8 engines w/ Thunderbolt IV & V ignition

IGNITION COIL



332- 4895A 8

Fits GM V-8 engines w/ Thunderbolt ignition

IGNITION COIL



806673T 1

Fits GM V-8 engines w/ Delco HEI ignition, except MPI engines w/ ECM 555

IGNITION COIL



8M0054588

Fits 2001 and newer MCM/MIE 4.3L, 5.0L, 5.7L & 6.2L MPI engines with ECM 555 (s/n 0M300000 thru 2A455878)

IGNITION COIL



300-8M0044991

Fits the F40/50/60 FourStroke (EFI, 4 cylinder) outboard beginning with serial number CHN 1C104424 and newer. Also fits MCM 4.5L V6.

IGNITION COIL



392-881732

Fits MCM 496 Mag & HO (s/n 0M025000-0M376087) and MIE 8.1L & HO (s/n 0M026000-0M315052).

IGNITION COIL

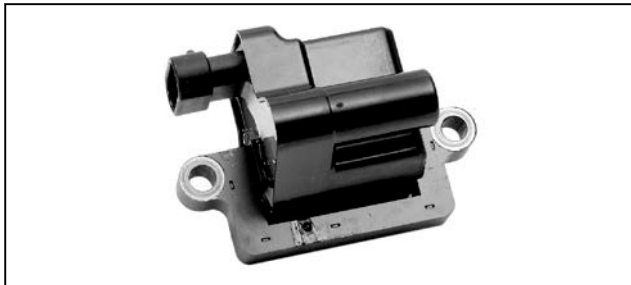

392-889925

Fits MCM 496 Mag & HO (s/n 0M376088 thru 1A352731) and MIE 8.1L & HO (s/n 0M315053 thru 1A380318).

SPARK PLUG WIRE KITS

SPARK PLUG WIRE KIT



84-816761Q 5

Fits GM 4 cyl. engines w/ conventional points ignition (1963-1995) Quicksilver Branded, Hanging Box Point of Sale Packaged.

SPARK PLUG WIRE KIT

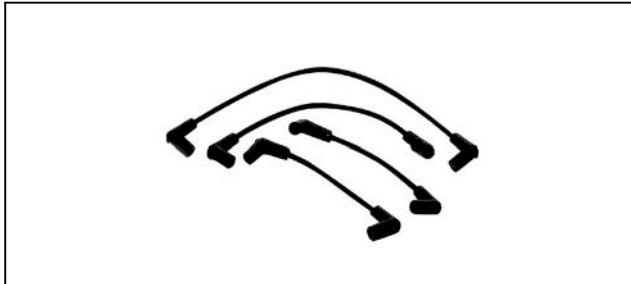

84-816761Q13

Fits MCM 3.0L/LX w/ Delco digital ignition (1990-1995) Quicksilver Branded, Hanging Box Point of Sale Packaged.

SPARK PLUG WIRE KIT



84-816761Q14

Fits MCM 3.0L/LX w/ Delco EST ignition (1990-2016)
Quicksilver Branded, Hanging Box Point of Sale Packaged.

SPARK PLUG WIRE KIT



84-816761Q 8

Fits GM in-line 6 cyl. Engines w/ conventional points ignition (1963-1981)
Quicksilver Branded, Hanging Box Point of Sale Packaged.

SPARK PLUG WIRE KIT



84-816761Q 7

Fits GM V-6 229 cid engines w/ conventional points ignition (1983-1984)
Quicksilver Branded, Hanging Box Point of Sale Packaged.

SPARK PLUG WIRE KIT

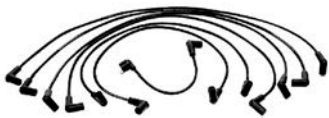

84-816761Q16

Fits GM V-6 262 cid engines w/ Thunderbolt IV ignition (1985-2003)
Quicksilver Branded, Hanging Box Point of Sale Packaged.

84-863656A04

blue wires
Fits GM V-6 262 cid engines w/ Thunderbolt IV ignition (2004-2015)

SPARK PLUG WIRE KIT



84-816608Q82

red wires
Fits GM V-6 262 cid engines w/ Delco HEI ignition (1996-2001)
Quicksilver Branded, Hanging Box Point of Sale Packaged.

SPARK PLUG WIRE KIT



84-863656A 2

Fits MCM 4.3L MPI

SPARK PLUG WIRE SET



84-8M0095475

Fits MCM 4.5L MPI

SPARK PLUG WIRE KIT



84-816761Q 9

Fits GM & Ford V-8 engines w/ conventional points ignition (1963-1982) and
Thunderbolt ignition (1968-1976)
Quicksilver Branded, Hanging Box Point of Sale Packaged.

84-816761Q12

Fits MIE 5.7L Tow Sports w/ conventional point ignition (1985-1995)
Quicksilver Branded, Hanging Box Point of Sale Packaged.

84-816761Q10

Fits GM V-8 454/482 cid engines w/ conventional points ignition (1977-1985) and Thunderbolt ignition (1969-1981)
Quicksilver Branded, Hanging Box Point of Sale Packaged.

SPARK PLUG WIRE KIT



84-816761Q17

Fits GM V-8 305/350 cid engines w/ Thunderbolt IV and V ignition (1987-2003)
Quicksilver Branded, Hanging Box Point of Sale Packaged.

84-863656A05

blue wires
Fits GM V-8 305/350 cid engines w/ Thunderbolt IV and V ignition (2004-2010)

84-816608Q83

red wires
Fits GM V-8 305/350/377 cid engines w/ Mercury ignition (1999-2001)
Quicksilver Branded, Hanging Box Point of Sale Packaged.

84-816761Q 3

Fits GM V-8 305/350 cid engines (RH) w/ Thunderbolt IV ignition (1981-1993)
Quicksilver Branded, Hanging Box Point of Sale Packaged.

84-816761Q 4

Fits GM V-8 305/350 cid engines (LH) w/ Thunderbolt IV ignition (1981-1995)
Quicksilver Branded, Hanging Box Point of Sale Packaged.

84-816608Q80

red wires
Fits 5.7L MIE & Tow Sports w/ Thunderbolt IV ignition (1998-2010)
Quicksilver Branded, Hanging Box Point of Sale Packaged.

84-847701Q24

Blue wires
Fits MIE 350 Mag Horizon (1999-2007)
Quicksilver Branded, Hanging Box Point of Sale Packaged.

84-816608Q61

red wires
Fits GM V-8 454/502 cid engines w/ Thunderbolt IV & V ignition (1981-1997)
Quicksilver Branded, Hanging Box Point of Sale Packaged.

84-847701Q 7

Blue wires
Fits GM Hi-Perf V-8 454/502/540/572 cid engines w/ Thunderbolt IV ignition (1990 and newer)
Quicksilver Branded, Hanging Box Point of Sale Packaged.

SPARK PLUG WIRE KIT



84-816608Q70

red wires
Fits GM V-8 305/350 cid engines w/ Delco HEI ignition (1995-1998)
Quicksilver Branded, Hanging Box Point of Sale Packaged.

84-816608Q71

red wires
Fits GM V-8 350 cid engines w/ Delco HEI ignition (1995-1998)
Quicksilver Branded, Hanging Box Point of Sale Packaged.

84-816608Q68

red wires
Fits GM V-8 350 & 454/502 cid engines w/ Delco HEI ignition (1993-2001)
Quicksilver Branded, Hanging Box Point of Sale Packaged.

84-816608Q78

red wires
Fits Black Scorpion Tow Sports w/ Delco HEI ignition (1997-1998)
Quicksilver Branded, Hanging Box Point of Sale Packaged.

84-816608Q81

red wires
Fits Black Scorpion Tow Sports w/ Delco HEI ignition (1999-2001)
Quicksilver Branded, Hanging Box Point of Sale Packaged.

84-847701Q26

Blue wires
Fit MCM 377 Scorpion (1999-2000)
Quicksilver Branded, Hanging Box Point of Sale Packaged.

84-847701Q17

Blue wires
Fits MIE 454 Mag MPI Horizon (1998)
Quicksilver Branded, Hanging Box Point of Sale Packaged.

84-847701Q25

Blues wires
Fits MCM 500 EFI (1998-2004) & 575 Sci (2000-2005)
Quicksilver Branded, Hanging Box Point of Sale Packaged.

SPARK PLUG WIRE KIT



84-863656A 1

Fits 2001-2015 MCM/MIE 5.0L, 5.7L & 6.2L MPI engines with ECM 555 (s/n 0M300000 thru 2A455878)

84-863656A03

Fits Black Scorpion Tow Sports & MX 6.2L Blk Scorpion Tow Sports (s/n 0M391599 thru 2A460164)

MERCURY® MERCURISER® IGNITION

SPARK PLUG WIRE KIT

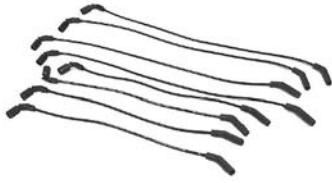

84-8M0117678

Fits MCM 496 Mag & HO and MIE 8.1L & HO (2000 and newer). Individual spark plug wires are also available separately. Use 84-888740 for cyl. 1,2,7 & 8. Use 84-888741 for cyl. 3,4,5 & 6.

SPARK PLUG WIRE KIT



84-899329A09

Fits MCM/MIE 8.2L engines (2010 and newer)

SPARK PLUG BOOT KIT

SPARK PLUG BOOT KIT



85-63709A 1

Fits various O/B & MCM applications
Priced individually, sold @ multiples of 10

MERCURY® MERCURISER®

IGNITION COIL, WIRES AND SPARK PLUG CHART

Coils, Wires, and Spark Plugs

Model	CID/ #Cyl	Type of Ignition	Year Range	Serial # Range	Ignition Coil	Wire Kit	Spark Plug	Gap
100 Vazer	98/ L4	Delco - HEI	2007 - 2009	1A035000 - 1A036006	N.L.A.	N.L.A.	33-896329818	.035
100 Vazer EC	98/ L4	Delco - HEI	2008 - 2009	1A035000 - 1A036006	N.L.A.	N.L.A.	33-896329818	.035
110	153/ L4	Delco	1963 - 1966	1537370 - 2044033	898253T24	84-816761Q 5	33-813471 1	.035
120	153/ L4	Delco	1964 - 1974	1666601 - 3825578	898253T24	84-816761Q 5	33-813471 1	.035
120	153/ L4	Delco	1974 - 1986	3825579 - 0B531853	898253T24	84-816761Q 5	33-898264001	.035
2.5L	153/ L4	Delco	1987 - 1989	0B531854 - 0C853255	898253T24	84-816761Q 5	33-898264001	.035
140 (4 cyl.)	181/ L4	Delco	1968 - 1974	2508261 - 3826282	898253T24	84-816761Q 5	33-813471 1	.035
140 (4 cyl.)	181/ L4	Delco	1974 - 1986	3826283 - 0B450800	898253T24	84-816761Q 5	33-898264001	.035
3.0L	181/ L4	Delco	1987 - 1989	0B450801 - 0C856558	898253T24	84-816761Q 5	33-898264001	.035
3.0L	181/ L4	Prestolite	1990 - 1991	0C856559 - 0D504541	898253T24	84-816761Q 5	33-898264001	.035
3.0L	181/ L4	Delco Digital	1990 - 1991	0C856559 - 0D504541	N.L.A.	84-816761Q13	33-898264001	.035
3.0L	181/ L4	EST	1991 - 1994	0D504542 - 0F603999	898253T27	84-816761Q14	33-898264001	.035
3.0L	181/ L4	EST	1998 - 2016	0L010042 - 2A506300	898253T27	84-816761Q14	33-816336Q	.035
3.0L MPI	181/ L4	EST	2008 - 2016	1A072812 - 2A502810	898253T27	84-816761Q14	33-816336Q	.035
3.0LX	181/ L4	Delco Digital	1990 - 1991	0C856559 - 0D504541	N.L.A.	84-816761Q13	33-816336Q	.035
3.0LX	181/ L4	EST	1991 - 1997	0D504542 - 0K999999	898253T27	84-816761Q14	33-816336Q	.035
165 (4 cyl.)	224/ L4	Delco	1987	0B434940 - 0B774251	898253T24	N.L.A.	33-97389	.035
170	224/ L4	Delco	1985 - 1986	6916779 - 0B434940	898253T24	N.L.A.	33-97389	.035
180	224/ L4	Delco	1987	0B436391 - 0B775248	898253T24	N.L.A.	33-97389	.035
180	224/ L4	Prestolite	1987	0B436391 - 0B775248	898253T24	84-816761Q 5	33-97389	.035

MERCURY® MERCURISER® IGNITION

MERCURY® MERCURISER®

Model	CID/ #Cyl	Type of Ignition	Year Range	Serial # Range	Ignition Coil	Wire Kit	Spark Plug	Gap
190 (4 cyl.)	224/ L4	Delco	1985 - 1986	6916779 - 0B436390	898253T24	N.L.A.	33- 97389	.035
3.7L	224/ L4	Delco	1988 - 1989	0B774252 and up	898253T24	N.L.A.	33- 97389	.035
3.7LX	224/ L4	Delco	1988 - 1989	0B775249 and up	898253T24	N.L.A.	33- 97389	.035
3.7LX	224/ L4	Prestolite	1988 - 1989	0B775249 and up	898253T24	84-816761Q 5	33- 97389	.035
470	224/ L4	Delco	1976 - 1984	4208730 - 6916778	898253T24	N.L.A.	33- 97389	.035
485	224/ L4	Delco	1980 - 1982	5685394 - 6218036	898253T24	N.L.A.	33- 97389	.035
488	224/ L4	Delco	1983 - 1984	6170297 - 6916778	898253T24	N.L.A.	33- 97389	.035
140 (6 cyl.)	194/ L6	Delco	1963	1538930 - 1725960	N.L.A.	84-816761Q 8	33-813471 1	.035
150	230/ L6	Delco	1964 - 1966	1666495 - 2048046	N.L.A.	84-816761Q 8	33-813471 1	.035
160	250/ L6	Delco	1967 - 1969	2048022 - 2770031	898253T24	84-816761Q 8	33-813471 1	.035
165 (6 cyl.)	250/ L6	Delco	1970	2770032 - 2771483	898253T24	84-816761Q 8	33-813471 1	.035
165 (6 cyl.)	250/ L6	Delco	1971 - 1981	2771484 - 5813433	898253T24	84-816761Q 8	33-898264001	.035
200 (6 cyl.)	292/ L6	Delco	1969	2453769 - 2712072	898253T24	84-816761Q 8	33-813471 1	.035
185 (4 bbl.)	229/ V-6	Prestolite	1983 - 1984	6330183 - 6919655	898253T24	84-816761Q 7	33-898264001	.035
175	262/ V-6	Thunderbolt IV	1987	0B527955 - 0B773242	300-8M0079202	84-816761Q16	33-898264001	.035
185 (2 bbl.)	262/ V-6	Thunderbolt IV	1985 - 1987	6919656 - 0B527954	300-8M0079202	84-816761Q16	33-898264001	.035
205	262/ V-6	Thunderbolt IV	1985 - 1987	0A331455 - 0B775129	300-8M0079202	84-816761Q16	33-898264001	.035
262 Mag.(TBI)(Gen+)	262/ V-6	Delco - HEI	1996 - 1997	0F803800 - 0K999999	898253T27	84-816608Q82	33-816336Q	.045
4.3L	262/ V-6	Thunderbolt IV	1988 - 1996	0B773243 - 0F802999	300-8M0079202	84-816761Q16	33-898264001	.035
4.3L (Gen +)	262/ V-6	Thunderbolt V	1998 - 2004	0L010044 - 0W300012	300-8M0079202	84-816761Q16	33-816336Q	.045
4.3L (Gen +)	262/ V-6	Thunderbolt V	2004 - 2015	0W300013 - 2A454127	300-8M0079202	84-863656A04	33-816336Q	.045
4.3L EFI (Gen+)(TBI)	262/ V-6	Delco - HEI	1998	0L012009 - 0L359999	898253T27	84-816608Q82	33-816336Q	.045
4.3L EFI (Gen+)(TBI)	262/ V-6	Mercury -HEI	1999 - 2001	0L360000 - 0M299999	300-8M0079202	84-816761Q16	33-816336Q	.045
4.3L MPI	262/ V-6	Delco - HEI	2001 - 2016	0M300000 - 2A506375	8M0054588	84-863656A 2	33-8M2018369	.060
4.3L MPI EC	262/ V-6	Delco - HEI	2011 - 2016	1A637496 - 2A528897	8M0054588	84-863656A 2	33-8M2018369	.060
4.3LH (Gen +)	262/ V-6	Thunderbolt V	1998 - 2002	0L010044 - 0M614999	300-8M0079202	84-816761Q16	33-816336Q	.045
4.3LX	262/ V-6	Thunderbolt IV	1988 - 1996	0B775130 - 0F802999	300-8M0079202	84-816761Q16	33-898264001	.035
4.3LX (Gen +)	262/ V-6	Thunderbolt V	1996 - 1997	0F803000 - 0K999999	300-8M0079202	84-816761Q16	33-816336Q	.045
4.5L MPI	275/ V-6	Mercury	2014 - 2019	2A441953 and up	300-8M0044991	84-8M0095475	33-8M0095454	.050
215 MCM & MIE (Ford)	302/ V-8	Autolite	1970 - 1972	2781153 - 3563181	898253T24	84-816761Q 9	N.L.A.	.030
215 MCM & MIE (Ford)	302/ V-8	Mallory	1970 - 1972	2781153 - 3563181	898253T24	84-816761Q 9	33-813425	.030
225 MCM & MIE (Ford)	302/ V-8	Autolite	1973 - 1974	3385721 - 4166999	898253T24	84-816761Q 9	33-813425	.030
225 MCM & MIE (Ford)	302/ V-8	Mallory	1973 - 1974	3385721 - 4166999	898253T24	84-816761Q 9	33-813425	.030
225 MCM & MIE (Ford)	302/ V-8	Mercury	1973 - 1974	3385721 - 4166999	898253T24	84-816761Q 9	33-813425	.030
888 (Ford)	302/ V-8	Mercury	1971 - 1977	3108723 - 4887829	898253T24	84-816761Q 9	33-813425	.030
888 (Ford)	302/ V-8	Prestolite	1971 - 1977	3108723 - 4887829	898253T24	84-816761Q 9	33-813425	.030
888 (Ford)	302/ V-8	Mallory	1971 - 1977	3108723 - 4887829	898253T24	84-816761Q 9	33-813425	.030
888 (Ford)	302/ V-8	Autolite	1971 - 1977	3108723 - 4887829	898253T24	84-816761Q 9	33-813425	.030
190 (GM 283)	283/ V-8	Delco	1963 - 1964	1564539 - 1730903	300-8M0079202	84-816761Q 9	N.L.A.	.035
198 MIE	305/ V-8	Mallory	1977	4776402 - 4931099	898253T24	84-816761Q 9	33-898264001	.035
200	305/ V-8	Thunderbolt IV	1985 - 1987	6899058 - 0B525981	300-8M0079202	84-816761Q 4	33-898264001	.035
200	305/ V-8	Thunderbolt IV(2)	1987	0B525982 - 0B774444	300-8M0079202	84-816761Q 4	33-898264001	.035
200	305/ V-8	Thunderbolt IV(1)	1987	0B525982 - 0B774444	300-8M0079202	84-816761Q17	33-898264001	.035
228	305/ V-8	Mallory	1977 - 1982	4765100 - 6218461	898253T24	84-816761Q 9	33-898264001	.035
228	305/ V-8	Thunderbolt IV	1983 - 1984	6218462 - 6899268	300-8M0079202	84-816761Q 4	33-898264001	.035
228 MIE	305/ V-8	Mallory	1977 - 1980	4765100 - 5907057	898253T24	84-816761Q 9	33-898264001	.035
230	305/ V-8	Thunderbolt IV	1985 - 1987	6899269 - 0B525981	300-8M0079202	84-816761Q 4	33-898264001	.035
230	305/ V-8	Thunderbolt IV(2)	1987	0B525982 - 0B773739	300-8M0079202	84-816761Q 4	33-898264001	.035
230	305/ V-8	Thunderbolt IV(1)	1987	0B525982 - 0B773739	300-8M0079202	84-816761Q17	33-898264001	.035

Not all parts listed are available for the European, C.I.S., Africa and Middle East Markets.
For more information, please contact your local Mercury, Mariner, MerCruiser or Quicksilver Office.

MERCURY® MERCURISER® IGNITION

MERCURY® MERCURISER®

Model	CID/ #Cyl	Type of Ignition	Year Range	Serial # Range	Ignition Coil	Wire Kit	Spark Plug	Gap
230 MIE (LH)	305/ V-8	Thunderbolt IV	1981 - 1987	5907058 - 0B788151	300-8M0079202	84-816761Q 4	33-898264001	.035
230 MIE (RH)	305/ V-8	Thunderbolt IV	1981 - 1987	5907058 - 0B788151	300-8M0079202	84-816761Q 3	33-898264001	.035
5.0L	305/ V-8	Thunderbolt IV(2)	1988 - 1995	0B774445 - 0F600999	300-8M0079202	84-816761Q 4	33-898264001	.035
5.0L	305/ V-8	Thunderbolt IV(1)	1988 - 1995	0B774445 - 0F600999	300-8M0079202	84-816761Q17	33-898264001	.035
5.0L (Gen +)	305/ V-8	Thunderbolt V	1998 - 2004	0L015751 - 0W300009	300-8M0079202	84-816761Q17	33-816336Q	.045
5.0L (Gen +)	305/ V-8	Thunderbolt V	2004 - 2009	0W300010 - 1A607561	300-8M0079202	84-863656A05	33-816336Q	.045
5.0L EFI (Gen +)	305/ V-8	Delco - HEI	1998	0L012052 - 0L339999	806673T 1	84-816608Q70	33-816336Q	.045
5.0L EFI (Gen +)	305/ V-8	Mercury -HEI	1999 - 2001	0L331631 - 0M299999	300-8M0079202	84-816608Q83	33-816336Q	.045
5.0L MIE (LH)	305/ V-8	Thunderbolt IV	1988	0B788152 - 0C396832	300-8M0079202	84-816761Q 4	33-898264001	.035
5.0L MIE (RH)	305/ V-8	Thunderbolt IV	1988	0B788152 - 0C396832	300-8M0079202	84-816761Q 3	33-898264001	.035
5.0L MPI	305/ V-8	Delco - HEI	2001 - 2014	0M300000 - 2A445009	8M0054588	84-863656A 1	33-8M2018369	.060
5.0L MPI EC	305/ V-8	Delco - HEI	2008 - 2014	1A300000 - 2A444777	8M0054588	84-863656A 1	33-8M2018369	.060
5.0LX	305/ V-8	Thunderbolt IV(2)	1988 - 1995	0B773740 - 0F600999	300-8M0079202	84-816761Q 4	33-898264001	.035
5.0LX	305/ V-8	Thunderbolt IV(1)	1988 - 1995	0B773740 - 0F600999	300-8M0079202	84-816761Q17	33-898264001	.035
898	305/ V-8	Mallory	1977 - 1982	4762210 - 6218461	898253T24	84-816761Q 9	33-898264001	.035
898	305/ V-8	Thunderbolt IV	1983 - 1984	6218462 - 6899057	300-8M0079202	84-816761Q 4	33-898264001	.035
225 (GM)	327/ V-8	Delco	1963 - 1969	1539620 - 2694014	898253T24	84-816761Q 9	N.L.A.	.035
225 MIE (GM)	327/ V-8	Thunderbolt	1968	2278647 - 2694014	332- 4895A 8	84-816761Q 9	33-813415	N/A
250 MCM & MIE	327/ V-8	Thunderbolt	1968 - 1969	2314301 - 2639854	332- 4895A 8	84-816761Q 9	33-813415	N/A
250	350/ V-8	Mallory	1977	4768000 - 4908849	898253T24	84-816761Q 9	33-898264001	.035
255 MCM & MIE (GM)	350/ V-8	Mallory	1975 - 1976	3258728 - 4501254	898253T24	84-816761Q 9	33-898264001	.035
255 MCM & MIE (GM)	350/ V-8	Mercury	1976	4498701 - 4767999	898253T24	84-816761Q 9	33-898264001	.035
255 MIE (GM)	350/ V-8	Mercury	1977 - 1980	4768000 - 5907057	898253T24	84-816761Q 9	33-898264001	.035
260	350/ V-8	Mallory	1978 - 1982	4908850 - 6218461	898253T24	84-816761Q 9	33-898264001	.035
260	350/ V-8	Thunderbolt IV	1982 - 1987	6218462 - 0B525981	300-8M0079202	84-816761Q 4	33-898264001	.035
260	350/ V-8	Thunderbolt IV(2)	1987	0B525982 - 0B773304	300-8M0079202	84-816761Q 4	33-898264001	.035
260	350/ V-8	Thunderbolt IV(1)	1987	0B525982 - 0B773304	300-8M0079202	84-816761Q17	33-898264001	.035
260 MIE (LH)	350/ V-8	Thunderbolt IV	1981 - 1987	5907058 - 0B788151	300-8M0079202	84-816761Q 4	33-898264001	.035
260 MIE (RH)	350/ V-8	Thunderbolt IV	1981 - 1987	5907058 - 0B788151	300-8M0079202	84-816761Q 3	33-898264001	.035
270 MCM & MIE	350/ V-8	Thunderbolt	1969 - 1972	2851074 - 3385720	332- 4895A 8	84-816761Q 9	33-813415	N/A
280 TRS	350/ V-8	Mercury	1975	4176250 - 4499390	898253T24	84-816761Q 9	33-898264001	.035
280 TRS	350/ V-8	Mallory	1976	4499391 - 4770199	898253T24	84-816761Q 9	33-898264001	.035
300	350/ V-8	Thunderbolt IV	1985 - 1986	6668677 - 0B430367	300-8M0079202	84-816761Q 4	33-898264001	.035
320 EFI	350/ V-8	Thunderbolt IV	1987 - 1989	0A543604 - 0C622418	300-8M0079202	84-816761Q 4	33-898264001	.035
350 Mag. Alpha	350/ V-8	Thunderbolt IV	1986 - 1987	0A635178 - 0B525981	300-8M0079202	84-816761Q 4	33-898264001	.035
350 Mag. Alpha	350/ V-8	Thunderbolt IV(2)	1987 - 1994	0B525982 - 0F353690	300-8M0079202	84-816761Q 4	33-898264001	.035
350 Mag. Alpha	350/ V-8	Thunderbolt IV(1)	1987 - 1994	0B525982 - 0F353690	300-8M0079202	84-816761Q17	33-898264001	.035
350 Mag. Alpha	350/ V-8	Thunderbolt V	1995 - 1997	0F353691 - 0K999999	300-8M0079202	84-816761Q17	33-898264001	.035
350 Mag. Alpha EFI (Gen+)	350/ V-8	Delco - HEI	1996 - 1997	0F800300 - 0K999999	806673T 1	84-816608Q70	33-816336Q	.045
350 Mag. Bravo MPI	350/ V-8	Delco - HEI	1995	0F415189 - 0F601999	898253T27	84-816608Q71	33-898264001	.035
350 Mag. Bravo MPI (Gen+)	350/ V-8	Delco - HEI	1996 - 1997	0F602000 - 0K999999	898253T27	84-816608Q71	33-816336Q	.045
350 Mag. EFI Ski	350/ V-8	Delco - HEI	1994 - 1996	0F215561 - 0F820706	806673T 1	84-816608Q68	33-898264001	.035
350 Mag. EFI Ski (Gen+)	350/ V-8	Delco - HEI	1996 - 1997	0F820707 - 0K999999	898253T27	84-816608Q68	33-816336Q	.045
350 Mag. MPI (Gen+)	350/ V-8	Delco - HEI	1998	0L010019 - 0L325952	898253T27	84-816608Q71	33-816336Q	.045
350 Mag. MPI (Gen+)	350/ V-8	Mercury -HEI	1999 - 2001	0L325953 - 0M299999	300-8M0079202	84-816608Q83	33-816336Q	.045
350 Mag. MPI	350/ V-8	Delco - HEI	2001 - 2015	0M300000 - 2A455872	8M0054588	84-863656A 1	33-8M2018369	.060
350 Mag. MPI EC	350/ V-8	Delco - HEI	2008 - 2015	1A300000 - 2A455878	8M0054588	84-863656A 1	33-8M2018369	.060
350 Mag. MPI Horizon	350/ V-8	Mercury -HEI	2000 - 2001	0L604000 - 0M299999	300-8M0079202	84-847701Q24	33-8M0046007	.045
350 Mag. MPI Horizon MIE	350/ V-8	Mercury -HEI	1999 - 2001	0L304700 - 0M299999	300-8M0079202	84-847701Q24	33-8M0046007	.045
350 Mag. MPI MIE (Gen+)	350/ V-8	Delco - HEI	1998	0L002008 - 0L302199	898253T27	84-816608Q68	33-816336Q	.045
350 Mag. MPI MIE (Gen+)	350/ V-8	Mercury -HEI	1998 - 2001	0L302200 - 0M299999	300-8M0079202	84-816608Q83	33-816336Q	.045
350 Mag. MPI MIE	350/ V-8	Delco - HEI	2001 - 2007	0M300000 - 1A089999	8M0054588	84-863656A 1	33-8M2018369	.060
350 Mag. MPI Ski	350/ V-8	Delco - HEI	1995 - 1996	0F350583 - 0F799999	898253T27	84-816608Q68	33-898264001	.035

Model	CID/ #Cyl	Type of Ignition	Year Range	Serial # Range	Ignition Coil	Wire Kit	Spark Plug	Gap
350 Mag. MPI Ski (Gen+)	350/ V-8	Delco - HEI	1998	0L002600 - 0L304599	898253T27	84-816608Q68	33-816336Q	.045
350 Mag. MPI Ski (Gen+)	350/ V-8	Mercury -HEI	1999 - 2001	0L304600 - 0M299999	300-8M0079202	84-816608Q83	33-816336Q	.045
350 Mag. MPI Ski	350/ V-8	Delco - HEI	2002 - 2007	0M300000 - 1A089999	8M0054588	84-863656A 1	33-8M2018369	.060
350 Mag. Ski	350/ V-8	Thunderbolt IV(2)	1991 - 1996	0D505450 - 0K040399	300-8M0079202	84-816761Q 4	33-898264001	.035
350 Mag. Ski	350/ V-8	Thunderbolt IV(1)	1991 - 1996	0D505450 - 0K040399	300-8M0079202	84-816761Q17	33-898264001	.035
5.7L Alpha	350/ V-8	Thunderbolt IV(2)	1988 - 1995	0B773305 - 0F600999	300-8M0079202	84-816761Q 4	33-898264001	.035
5.7L Alpha	350/ V-8	Thunderbolt IV(1)	1988 - 1995	0B773305 - 0F600999	300-8M0079202	84-816761Q17	33-898264001	.035
5.7L	350/ V-8	Thunderbolt V	1996 - 1997	0F601000 - 0K999999	300-8M0079202	84-816761Q17	33-898264001	.035
5.7L (Gen +)	350/ V-8	Thunderbolt V	1998 - 2009	0L010037 - 1A600136	300-8M0079202	84-816761Q17	33-816336Q	.045
5.7L Bravo	350/ V-8	Thunderbolt IV(2)	1992 - 1993	0D617328 - 0F353524	300-8M0079202	84-816761Q 4	33-898264001	.035
5.7L Bravo	350/ V-8	Thunderbolt IV(1)	1992 - 1993	0D617328 - 0F353524	300-8M0079202	84-816761Q17	33-898264001	.035
5.7L Bravo (Gen +)	350/ V-8	Thunderbolt V	2004 - 2009	0W300754 - 1A600136	300-8M0079202	84-863656A05	33-816336Q	.045
5.7L EFI	350/ V-8	Delco - HEI	1995 - 1997	0F225560 - 0K999999	806673T 1	84-816608Q70	33-898264001	.035
5.7L EFI (Gen +)	350/ V-8	Delco - HEI	1998	0L010035 - 0L325976	806673T 1	84-816608Q70	33-816336Q	.045
5.7L EFI (Gen +)	350/ V-8	Delco - HEI	1998	0L326000 - 0L331598	806673T 1	84-816608Q70	33-816336Q	.045
5.7L EFI (Gen +)	350/ V-8	Delco - HEI	1998	0L331992 - 0L335715	806673T 1	84-816608Q70	33-816336Q	.045
5.7L EFI (Gen +)	350/ V-8	Delco - HEI	1998	0L336000 - 0L339999	806673T 1	84-816608Q70	33-816336Q	.045
5.7L EFI (Gen +)	350/ V-8	Mercury -HEI	1999	0L325977 - 0L325999	300-8M0079202	84-816608Q83	33-816336Q	.045
5.7L EFI (Gen +)	350/ V-8	Mercury -HEI	1999	0L331599 - 0L331991	300-8M0079202	84-816608Q83	33-816336Q	.045
5.7L EFI (Gen +)	350/ V-8	Mercury -HEI	1999	0L335716 - 0L335999	300-8M0079202	84-816608Q83	33-816336Q	.045
5.7L EFI (Gen +)	350/ V-8	Mercury -HEI	1999 - 2001	0L340000 - 0M299999	300-8M0079202	84-816608Q83	33-816336Q	.045
5.7L EFI MIE (Gen+)	350/ V-8	Delco - HEI	1997	0K040300 - 0K999999	806673T 1	84-816608Q70	33-816336Q	.045
5.7L MIE (LH)	350/ V-8	Thunderbolt IV	1988 - 1993	0B788152 - 0F024999	300-8M0079202	84-816761Q 4	33-898264001	.035
5.7L MIE (RH)	350/ V-8	Thunderbolt IV	1988 - 1993	0B788152 - 0F024999	300-8M0079202	84-816761Q 3	33-898264001	.035
5.7L MIE	350/ V-8	Thunderbolt IV(2)	1993 - 1995	0F025000 - 0F622099	300-8M0079202	84-816761Q 4	33-898264001	.035
5.7L MIE	350/ V-8	Thunderbolt IV(1)	1993 - 1995	0F025000 - 0F622099	300-8M0079202	84-816761Q17	33-898264001	.035
5.7L MIE	350/ V-8	Thunderbolt IV	1995 - 1997	0F622151 - 0K999999	300-8M0079202	84-816761Q17	33-898264001	.035
5.7L MIE (Gen+)	350/ V-8	Thunderbolt V	1998 - 2010	0L002003 - 1A092388	300-8M0079202	84-816608Q80	33-816336Q	.045
5.7 MPI MIE	350/ V-8	Delco -HEI	2008 - 2015	1A090000 - 2A455523	8M0054588	84-863656A 1	33-8M2018369	.060
5.7 MPI MIE EC	350/ V-8	Delco -HEI	2008 - 2016	1A090000 - 2A455371	8M0054588	84-863656A 1	33-8M2018369	.060
5.7 MPI Tow Sports	350/ V-8	Delco -HEI	2008 - 2015	1A090000 - 2A455977	8M0054588	84-863656A 1	33-8M2018369	.060
5.7L MPI Tow Sports w/ Gen III	350/ V-8	Delco -HEI	2009 - 2015	1A091881 - 2A456039	8M0054588	84-863656A 1	33-8M2018369	.060
5.7 MPI Tow Sports EC	350/ V-8	Delco -HEI	2008 - 2015	1A090000 - 2A452508	8M0054588	84-863656A 1	33-8M2018369	.060
5.7L Ski	350/ V-8	Prestolite	1985 - 1995	0A338553 - 0F775199	898253T24	84-816761Q12	33-898264001	.035
5.7L Ski	350/ V-8	Mallory	1985 - 1995	0A338553 - 0F775199	898253T24	84-816761Q12	33-898264001	.035
5.7L Ski	350/ V-8	Thunderbolt IV(2)	1987 - 1995	0B514627 - 0F775199	300-8M0079202	84-816761Q 4	33-898264001	.035
5.7L Ski	350/ V-8	Thunderbolt IV(1)	1987 - 1995	0B514627 - 0F775199	300-8M0079202	84-816761Q17	33-898264001	.035
5.7L Ski	350/ V-8	Thunderbolt V	1996 - 1997	0F775200 - 0K999999	300-8M0079202	84-816761Q17	33-898264001	.035
5.7L Ski (Gen +)	350/ V-8	Thunderbolt V	1998 - 2004	0L002005 - 0W090899	300-8M0079202	84-816608Q80	33-816336Q	.045
5.7L Ski (Gen +)	350/ V-8	Thunderbolt V	2004 - 2011	0W090900 - 1A092837	300-8M0079202	84-863656A05	33-816336Q	.045
5.7LX	350/ V-8	Thunderbolt V	1996 - 1997	0F601000 - 0K999999	300-8M0079202	84-816761Q17	33-898264001	.035
5.7LX Bravo EFI (Gen +)	350/ V-8	Delco - HEI	1996 - 1997	0F800300 - 0K999999	806673T 1	84-816608Q70	33-816336Q	.045
5.7LX EFI	350/ V-8	Delco - HEI	1996 - 1997	0F752400 - 0K999999	806673T 1	84-816608Q70	33-898264001	.035
Black Scorpion Ski (Gen+)	350/ V-8	Delco - HEI	1996	0F800000 - 0K040000	898253T27	84-816608Q68	33-816336Q	.045
Black Scorpion Ski (Gen+)	350/ V-8	Delco - HEI	1997 - 1998	0K040001 - 0L005600	898253T27	84-816608Q78	33-816336Q	.045
Black Scorpion Ski (Gen+)	350/ V-8	Delco - HEI	1998 - 2002	0L005601 - 0M391599	898253T27	84-816608Q81	33-816336Q	.045
Black Scorpion Ski (Gen+)	350/ V-8	Mercury - HEI	2003 - 2007	0M391600 - 0W698432	8M0054588	84-863656A03	33-8M2018369	.060
Scorpion 350	350/ V-8	Mercury - HEI	2008 - 2015	0W698433 - 2A460164	8M0054588	84-863656A03	33-8M2018369	.060
Scorpion 350 EC	350/ V-8	Mercury - HEI	2008 - 2015	0W698433 - 2A460148	8M0054588	84-863656A03	33-8M2018369	.060
233 MCM & MIE (Ford)	351/ V-8	Mercury	1975 - 1977	4173000 - 4902304	898253T24	84-816761Q 9	33-813425	.030
233 MCM & MIE (Ford)	351/ V-8	Prestolite	1975 - 1977	4173000 - 4902304	898253T24	84-816761Q 9	33-813425	.030
255 MCM & MIE (Ford)	351/ V-8	Mallory	1973 - 1980	3258728 - 5907057	898253T24	84-816761Q 9	33-813425	.030
255 MCM & MIE (Ford)	351/ V-8	Mercury	1973 - 1980	3258728 - 5907057	898253T24	84-816761Q 9	33-813425	.030

Not all parts listed are available for the European, C.I.S., Africa and Middle East Markets.
 For more information, please contact your local Mercury, Mariner, MerCruiser or Quicksilver Office.

MERCURY® MERCURISER® IGNITION

MERCURY® MERCURISER®

Model	CID/ #Cyl	Type of Ignition	Year Range	Serial # Range	Ignition Coil	Wire Kit	Spark Plug	Gap
377 Mag, RWC	377/ V-8	Delco -HEI	2008 - 2015	1A300000 - 2A455858	8M0054588	84-863656A 1	33-8M2018369	.060
377 Mag EC	377/ V-8	Delco -HEI	2008 - 2015	1A300000 - 2A455601	8M0054588	84-863656A 1	33-8M2018369	.060
377 Scorpion MCM	377/ V-8	Delco - HEI	1999 - 2005	0L416146 - 0M907201	898253T27	-	33-816336Q	.045
377 Scorpion Ski	377/ V-8	Delco - HEI	1997 - 1998	0K000656 - 0L600314	898253T27	84-847701Q18	33-816336Q	.045
6.2L MPI	377/ V-8	Mercury	2015 - 2019	2A456613 and up	300-8M0044991	84-8M0104881	33-8M0095454	.051
MX 6.2L MPI	377/ V-8	Mercury -HEI	2000 - 2001	0L680003 - 0M299999	300-8M0079202	84-816608Q83	33-862029	.045
MX 6.2L MPI	377/ V-8	Delco -HEI	2001 - 2007	0M300000 - 1A299999	8M0054588	84-863656A 1	33-8M2018369	.060
MX 6.2L MPI MIE	377/ V-8	Delco -HEI	2001 - 2015	0M300000 - 2A452368	8M0054588	84-863656A 1	33-8M2018369	.060
MX 6.2L MPI MIE EC	377/ V-8	Delco -HEI	2008 - 2015	1A090000 - 2A455246	8M0054588	84-863656A 1	33-8M2018369	.060
MX 6.2L MPI Ski	377/ V-8	Delco -HEI	2003 - 2006	0M317000 - 0W689999	8M0054588	84-863656A03	33-8M2018369	.060
MX 6.2L Blk Scorpion Ski	377/ V-8	Delco -HEI	2001 - 2002	0L670015 - 0M391599	898253T27	84-816608Q81	33-816336Q	.045
MX 6.2L Blk Scorpion Ski	377/ V-8	Mercury -HEI	2003 - 2007	0M391750 - 0W698432	8M0054588	84-863656A03	33-8M2018369	.060
Scorpion 377	377/ V-8	Mercury - HEI	2008 - 2015	0W698433 - 2A460138	8M0054588	84-863656A03	33-8M2018369	.060
Scorpion 377 HO EC	377/ V-8	Mercury - HEI	2009 - 2010	1A091488 - 1A092170	8M0054588	84-863656A03	33-8M2018369	.060
325 MCM & MIE	427/ V-8	Thunderbolt	1969 - 1974	2278747 and up	332- 4895A 8	84-816761Q 9	33-813421 4	.035
330 MCM & MIE	454/ V-8	Mallory	1977 - 1981	4623115 - 6083144	898253T24	84-816761Q10	33-898264001	.035
330 MCM & MIE	454/ V-8	Thunderbolt	1977 - 1981	4623115 - 6083144	332- 4895A 8	84-816761Q10	33-813421 4	.035
330	454/ V-8	Thunderbolt IV	1982 - 1987	6083145 - 0B816540	300-8M0079202	84-816608Q61	33-898264001	.035
340 MIE	454/ V-8	Thunderbolt IV	1981 - 1987	5889914 - 0B788365	300-8M0079202	84-816608Q61	33-898264001	.035
350 MIE	454/ V-8	Thunderbolt	1974 - 1976	3780450 - 4623109	332- 4895A 8	84-816761Q 9	33-813421 4	.035
370 TRS	454/ V-8	Mallory	1978 - 1985	4179554 - 6721527	898253T24	84-816761Q10	33-898264001	.035
370 TRS	454/ V-8	Holley	1978 - 1985	4883520 - 6721527	898253T24	84-816761Q10	33-898264001	.035
370 TRS	454/ V-8	Thunderbolt IV	1985 - 1987	6721528 - 0B714586	898253T24	84-816608Q61	33-898264001	.035
400 TRS	454/ V-8	Mallory	1980 - 1986	5668232 - 0B457644	898253T24	84-816761Q10	33-813421 4	.035
400 TRS	454/ V-8	Holley	1980 - 1986	5668232 - 0B457644	898253T24	84-816761Q10	33-898264001	.035
420	454/ V-8	Thunderbolt IV	1987 - 1989	0A398941 - 0B622418	300-8M0079202	84-847701Q 7	33-898264001	.035
425	454/ V-8	Thunderbolt IV	1990 - 1993	0B622419 - 0D937011	300-8M0079202	84-847701Q 7	33-898264001	.035
440 TRS	454/ V-8	Mallory	1983 - 1986	6181070 - 0B485220	898253T24	84-816761Q10	33-898264001	.035
440 TRS	454/ V-8	Holley	1983 - 1986	6181070 - 0B485220	898253T24	84-816761Q10	33-898264001	.035
450	454/ V-8	Thunderbolt IV	1995 - 1996	0F347100 - 0F347277	300-8M0079202	84-816608Q61	33-898264001	.035
454 Mag. Alpha	454/ V-8	Thunderbolt IV	1986 - 1988	0A631894 - 0B785148	300-8M0079202	84-816608Q61	33-898264001	.035
454 Mag. Bravo	454/ V-8	Thunderbolt IV(2)	1988 - 1992	0B721206 - 0D805068	300-8M0079202	84-816608Q61	33-898264001	.035
454 Mag. Bravo	454/ V-8	Thunderbolt IV(1)	1988 - 1992	0B721206 - 0D805068	300-8M0079202	84-816608Q61	33-898264001	.035
454 Mag. Bravo	454/ V-8	Thunderbolt IV & V	1992 - 1997	0D805069 - 0K999999	300-8M0079202	84-816608Q61	33-898264001	.035
454 Mag. EFI	454/ V-8	Delco - HEI	1994 - 1996	0F115700 - 0F802349	898253T27	84-816608Q68	33-898264001	.035
454 Mag. MPI	454/ V-8	Delco - HEI	1996 - 2001	0F802350 - 0M024999	898253T27	84-816608Q68	33-898264001	.040
454 Mag. MPI Horizon MIE	454/ V-8	Delco - HEI	1998	0L002200 - 0L086000	898253T27	84-847701Q17	33-898264001	.040
454 Mag. MPI Horizon MIE	454/ V-8	Delco - HEI	1999 - 2001	0L086001 - 0L674000	898253T27	84-816608Q68	33-898264001	.040
454 Mag. MPI Ski	454/ V-8	Delco - HEI	1995 - 1997	0F215800 - 0K999999	898253T27	84-816608Q68	33-898264001	.035
525 SC	454/ V-8	Firepower	1991 - 1992	0D456000 - 0D763831	N.L.A.	84-816608Q61	33-813421 4	.035
525 SC	454/ V-8	Thunderbolt IV	1992 - 1995	0D763871 - 0F877734	300-8M0079202	84-816608Q61	33-813421 4	.035
525 SC	454/ V-8	Thunderbolt V	1996 - 1999	0K000012 - 0L415623	300-8M0079202	84-847701Q 7	33-813421 4	.035
7.4L Bravo	454/ V-8	Thunderbolt IV & V	1988 - 1997	0B771113 - 0K999999	300-8M0079202	84-816608Q61	33-898264001	.035
7.4L EFI MIE	454/ V-8	Delco - HEI	1996 - 1997	0F874815 - 0K999999	898253T27	84-816608Q68	33-898264001	.035
7.4L MIE	454/ V-8	Thunderbolt IV & V	1988 - 1997	0B788366 - 0K999999	300-8M0079202	84-816608Q61	33-898264001	.035
7.4L MPI (L29)	454/ V-8	Delco - HEI	1998 - 2001	0L010003 - 0M024330	898253T27	84-816608Q68	33-816336Q	.045
7.4L MPI MIE	454/ V-8	Delco - HEI	1995 - 1997	0F563052 - 0K999999	898253T27	84-816608Q68	33-898264001	.035
7.4L MPI MIE (L29)	454/ V-8	Delco - HEI	1998 - 2001	0L002006 - 0L674613	898253T27	84-816608Q68	33-816336Q	.045
7.4LX Bravo EFI	454/ V-8	Delco - HEI	1996 - 1997	0F820000 - 0K999999	898253T27	84-816608Q68	33-898264001	.035
7.4LX Bravo MPI	454/ V-8	Delco - HEI	1996 - 1997	0F602010 - 0K999999	898253T27	84-816608Q68	33-898264001	.035
390	482/ V-8	Thunderbolt	1969 - 1970	2781129 - 2825059	332- 4895A 8	84-816761Q10	N.L.A.	.035

MERCURY® MERCUISER® IGNITION

MERCURY® MERCUISER®

Model	CID/ #Cyl	Type of Ignition	Year Range	Serial # Range	Ignition Coil	Wire Kit	Spark Plug	Gap
460 TRS	482/ V-8	Mallory	1983 - 1986	6180970 - 6181046	898253T24	84-816761Q10	33-813421 4	.035
460 TRS	482/ V-8	Holley	1983 - 1986	6180970 - 6181046	898253T24	84-816761Q10	33-813421 4	.035
496 Mag	496/ V-8	Delco	2001 - 2004	0M025000 - 0W029410	392-881732	84-8M0117678(3)	33-8M0129146	.060
496 Mag	496/ V-8	Delco	2004 - 2010	0W029411 - 1A351548	392-889925	84-8M0117678(3)	33-8M0129146	.060
496 Mag, EC	496/ V-8	Delco	2008 - 2010	1A066166 - 1A350440	392-889925	84-8M0117678(3)	33-8M0129146	.060
496 Mag HO	496/ V-8	Delco	2001 - 2004	0M025000 - 0W029410	392-881732	84-8M0117678(3)	33-8M0129146	.060
496 Mag HO	496/ V-8	Delco	2004 - 2011	0W029411 - 1A352731	392-889925	84-8M0117678	33-8M0129146	.060
496 Mag HO, EC	496/ V-8	Delco	2008 - 2010	1A066166 - 1A350440	392-889925	84-8M0117678(3)	33-8M0129146	.060
8.1S MIE	496/ V-8	Delco	2001 - 2004	0M026000 - 0W089999	392-881732	84-8M0117678(3)	33-8M0129146	.060
8.1S MIE	496/ V-8	Delco	2004 - 2010	0W090000 - 1A380318	392-889925	84-8M0117678(3)	33-8M0129146	.060
8.1S MIE, EC	496/ V-8	Delco	2008 - 2009	0W697154 - 1A380251	392-889925	84-8M0117678(3)	33-8M0129146	.060
8.1S HO MIE	496/ V-8	Delco	2001 - 2004	0M026000 - 0W089999	392-881732	84-8M0117678(3)	33-8M0129146	.060
8.1S HO MIE	496/ V-8	Delco	2004 - 2010	0W090000 - 1A380318	392-889925	84-8M0117678(3)	33-8M0129146	.060
8.1S HO MIE, EC	496/ V-8	Delco	2008 - 2009	0W697154 - 1A380251	392-889925	84-8M0117678(3)	33-8M0129146	.060
465	502/ V-8	Firepower	1990 - 1992	0C849992 - 0D763731	N.L.A.	84-816608Q61	33-898264001	.035
465	502/ V-8	Thunderbolt IV	1992 - 1994	0D763732 - 0F213244	300-8M0079202	84-847701Q 7	33-898264001	.035
500	502/ V-8	Thunderbolt IV & V	1994 - 1998	0F213293 - 0L001772	300-8M0079202	84-847701Q 7	33-898264001	.035
500 (Gen +)	502/ V-8	Thunderbolt V	1999	0L414639 - 0L601036	300-8M0079202	84-847701Q 7	33-898264001	.035
500 EFI	502/ V-8	Delco - HEI	1998 - 2005	0L001477 - 0M907127	898253T27	84-847701Q25	33-898264001	.035
502 Mag, Bravo	502/ V-8	Thunderbolt IV	1990 - 1993	0C878221 - 0F114528	300-8M0079202	84-816608Q61	33-898264001	.035
502 Mag EFI	502/ V-8	Delco - HEI	1993 - 1996	0D840650 - 0F802599	898253T27	84-816608Q68	33-898264001	.035
502 Mag, MPI	502/ V-8	Delco - HEI	1996 - 2001	0F802600 - 0M024999	898253T27	84-816608Q68	33-898264001	.040
575 SCi	502/ V-8	Delco - HEI	2000 - 2005	0L306696 - 0M950526	898253T27	84-847701Q25	33-813421 4	.040
600 SC	502/ V-8	Firepower	1991 - 1993	0D456489 - 0D763875	N.L.A.	84-847701Q 7	33-813421 4	.035
600 SC	502/ V-8	Thunderbolt IV	1993 - 2000	0D763876 - 0L601186	300-8M0079202	84-847701Q 7	33-813421 4	.035
8.2L Mag EC	502/ V-8	Mercury	2010 - 2019	1A350340 and up	841203T	84-899329A09	33-8M0114747	.035
8.2L Mag HO EC	502/ V-8	Mercury	2010 - 2019	1A350340 and up	841203T	84-899329A09	33-8M0114747	.035
8.2L MIE	502/ V-8	Thunderbolt IV	1990 - 1996	0C878221 - 0F819619	300-8M0079202	84-816608Q61	33-898264001	.035
8.2L MIE EC	502/ V-8	Mercury	2010 - 2019	1A350802 and up	841203T	84-899329A09	33-8M0114747	.035
8.2L HO MIE EC	502/ V-8	Mercury	2010 - 2019	1A350802 and up	841203T	84-899329A09	33-8M0114747	.035
8.2L MPI MIE	502/ V-8	Delco - HEI	1996 - 2001	0F819620 - 0L674200	898253T27	84-816608Q68	33-898264001	.040
500 Bulldog	540/ V-8	Thunderbolt IV & V	1990 - 2001	0C577003 - 0M050281	300-8M0079202	84-847701Q 7	33-898264001	.035
575	540/ V-8	Thunderbolt IV	1986 - 1992	0A677429 - 0D763716	300-8M0079202	84-847701Q 7	33-813421 4	.035
800SC	572/ V-8	Thunderbolt IV & V	1993 - 2019	0D763836 and up	300-8M0079202	84-847701Q 7	33-813421 4	.035

(1) Distributor mounted ignition amplifier

(2) Exhaust elbow mounted ignition amplifier

(3) Individual spark plug wires are also available separately. Use 84-888740 for cylinders 1,2,7 & 8. Use 84-888741 for cylinders 3,4,5 & 6.

IGNITION MODULES

IGNITION MODULE



15248T01

Stamped V-8 24
 NLA - Ref MCM Service Bulletin 2009-14
 Fits MCM/MIE 5.0L, 5.7L & 7.4L engines w/ Thunderbolt IV ignition

821125A 1

Stamped V-8 24S
 Fits MCM & Tow Sports 5.7L engines w/ Thunderbolt IV ignition

IGNITION MODULE CONVERSION KIT



15247T02

V-6 14
 Fits 1987-1993 MCM 4.3L engines w/ Thunderbolt IV ignition

15248T02

V-8 24
 NLA Reference MCM S.B. 2009-14
 Fits MCM/MIE 5.0L, 5.7L & 7.4L engines w/ Thunderbolt IV ignition

15899T02

V-8 22
 Fits MCM/MIE 5.0L & 5.7L w/ Thunderbolt IV ignition

821125T02

V-8 24S
 Fits MCM & Tow Sports 5.7L engines w/ Thunderbolt IV ignition

879288A10

V-8 20R
 Fits MCM 502 Mag MPI, MIE 8.2L w/ Thunderbolt IV ignition
 Fits MCM 600 SC & 800SC w/ Thunderbolt IV ignition

IGNITION MODULE



805361T 2

Fits MCM/MIE 7.4L & 454 Mag w/ Thunderbolt IV ignition

805361T 5

Fits MCM/MIE 8.2L engines w/ Thunderbolt IV ignition

ICM MODULES

ICM MODULE CONVERSION KIT



861251A 1

Fits MCM 4.3LX/LXH Alpha Gen+ w/ Thunderbolt V ignition

861252A 2

Fits MCM 4.3LX/LXH Bravo Gen+ w/ Thunderbolt V ignition

807264A01

Fits MCM 5.7L/LX Alpha w/ Thunderbolt V ignition

806956A01

Fits MCM 5.7L/LX Bravo & MIE w/ Thunderbolt V ignition

807645A01

Fits Tow Sports 5.7L w/ Thunderbolt V ignition

806958A01

Fits MIE 350 Mag Tow Sports w/ Thunderbolt V ignition

806959A01

Fits MCM 7.4L Bravo w/ Thunderbolt V ignition

806960A01

Fits MCM 7.4L Bravo III w/ Thunderbolt V ignition

806961A01

Fits MIE 7.4L w/ Thunderbolt V ignition

806745A01

Fits MCM 454 Mag w/ Thunderbolt V ignition

807085A01

Fits MIE 8.2L w/ Thunderbolt V ignition

ICM MODULE

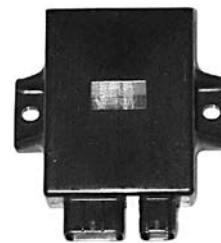

861251T 1

Fits MCM 4.3L/LH Alpha Gen+ w/ Thunderbolt V ignition

861252T 1

Fits MCM 4.3L/LH Bravo Gen+ w/ Thunderbolt V ignition

861459T02

Fits MCM 5.0L Alpha Gen+ w/ Thunderbolt V ignition

861460T02

Fits MCM 5.0L Bravo Gen+ w/ Thunderbolt V ignition

861253T02

Fits MCM 5.7L Alpha Gen+ w/ Thunderbolt V ignition

861254T02

Fits MCM 5.7L Bravo Gen+ w/ Thunderbolt V ignition

861255T02

Fits MIE 5.7L Tow Sports w/ Thunderbolt V ignition

861543T02

Fits MIE 5.7L Gen+ w/ Thunderbolt V ignition

MERCURY® MERCURISER®

MERCURY® MERCUISER® ELECTRICAL SYSTEM

STARTER SLAVE SOLENOIDS

SOLENOID



25661T 1

Used for power trim and starting systems
Fits various O/B & MCM applications

SOLENOID



65057T 1

Used for starting system
Fits various MCM engines

SOLENOID



89- 76416A 1

Grounded Base

SOLENOID



89- 96054T

Flat mounting plate
Fits In-Line 6 Outboards & MerCruiser engines

SOLENOID



89- 96158T

Stepped mounting plate
Fits Outboard Starters & MerCruiser Starters and Pwr Trim.

SOLENOID



89-818999A 2

Used for starting systems
Fits various O/B and MCM applications

SOLENOID



89-850188T 1

Fits Outboard 6 - 25 Hp and 50 - 60 Hp 3 Cyl. & MCM applications

SOLENOID



89-850187T 1

Contains rubber insulating mounts.
Review the Electronic Parts Catalog for your specific application.

MERCURY® MERCUISER®

SOLENOID



89-853654A 1

Fits Outboard 2 Cyl. & In-Line 6 & MCM applications

RELAY



86-865202T

Used for P/T, starting, main power & fuel pump systems
Fits various MCM applications

RELAY



882751

Fits various O/B and MCM applications

RELAY ASSEMBLY



882751A 1

Includes rubber insulating mount.
Review the Electronic Parts Catalog for your specific application.

RELAY



882751A04

Used on 200/225/250/275 Verado outboards beginning with Model Year 2005. Also used on MCM 496 & MIE 8.1L.

RELAY

Image not Available.

8M0057697

Fits 150 EFI FourStroke and MCM 4.5L and 6.2L MPI

ELECTRICAL HARNESS REPAIR KITS

MOLEX REPAIR KIT, 14-PIN, FEMALE

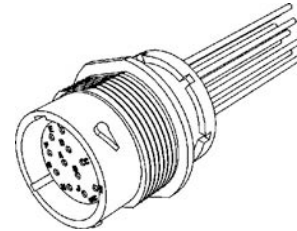

84-8M0062009

Use when the replacement of the entire harness is not necessary. Includes the Molex 14-pin female connector and 14 crimp splices.
Fits all MCM & O/B engines with the 14 pin Molex engine harness

MOLEX REPAIR KIT, 14-PIN, MALE



8M0096940

Use when the replacement of the entire harness is not necessary. Includes the Molex 14-pin male connector and 14 crimp splices.
Fits all MCM & O/B engines with the 14 pin Molex engine harness

TMAP TEMPERATURE AND MANIFOLD AIR PRESSURE REPAIR KIT, 4-PIN, FEMALE

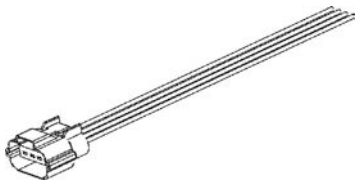

84-8M0062010

Use when the replacement of the entire harness is not necessary. Includes the TMAP 4-pin female connector and 4 crimp splices.

Fits MCM 3.0L MPI EC engines TMAP sensor

O2 SENSOR REPAIR KIT, 4-PIN, MALE

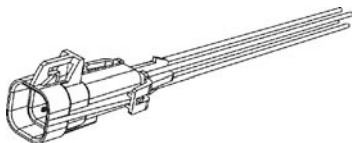

84-8M0062011

Use when the replacement of the entire harness is not necessary. Includes the O2 sensor 4-pin male connector and 4 crimp splices.

Fits MCM EC engines O2 sensor

CPS CRANK POSITION SENSOR REPAIR KIT, 3-PIN, FEMALE

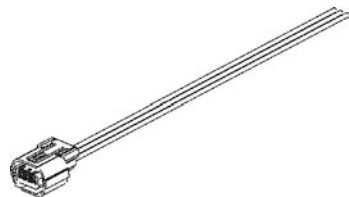

84-8M0062012

Use when the replacement of the entire harness is not necessary. Includes the Crank Position 3-pin female connector and 3 crimp splices.

Fits MCM V-6 engines with CPS

MAT MANIFOLD AIR TEMPERATURE REPAIR KIT, 2-PIN, FEMALE

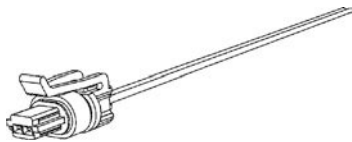

84-8M0062013

Use when the replacement of the entire harness is not necessary. Includes the MAT 2-pin female connector and 2 crimp splices.

Fits MCM 8.2L engines MAT sensor

PACKARD REPAIR KIT, 2-PIN, MALE

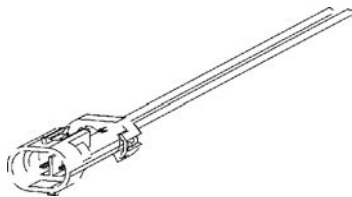

84-8M0062014

Use when the replacement of the entire harness is not necessary. Includes the Packard 2-pin male connector and 2 crimp splices.

Fits MCM engines with Packard 2-pin connector for clean power

PACKARD REPAIR KIT, 6-PIN, FEMALE

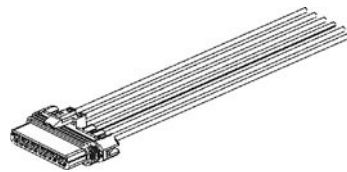

84-8M0062015

Use when the replacement of the entire harness is not necessary. Includes the Packard 6-pin female connector and 6 crimp splices.

Fits MCM 3.0L MPI engines with Packard 6-pin connector for engine O2 sensor mini fuses

PACKARD REPAIR KIT, 8-PIN, FEMALE

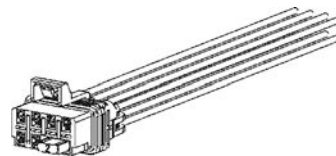

84-8M0062016

Use when the replacement of the entire harness is not necessary. Includes the Packard 8-pin female connector and 8 crimp splices.

Fits MCM engines with Packard 8-pin connector for engine mini fuses

PACKARD REPAIR KIT, 2-PIN, FEMALE

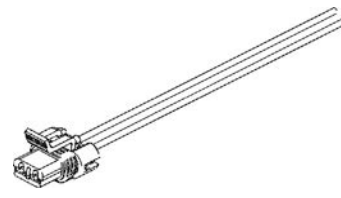

84-8M0062017

Use when the replacement of the entire harness is not necessary. Includes the Packard 2-pin female connector and 2 crimp splices.

Fits MCM engines with Packard 2-pin connector for fuel pump, 2 amp OBDM fuse and shift switch

PACKARD REPAIR KIT, 3-PIN, MALE

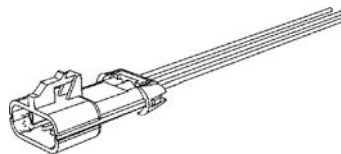

84-8M0062018

Use when the replacement of the entire harness is not necessary. Includes the Packard 3-pin male connector and 3 crimp splices.

Fits MCM engines with Packard 3-pin connector for shift interrupt and neutral safety switch

FUEL INJECTOR REPAIR KIT, 2-PIN, FEMALE

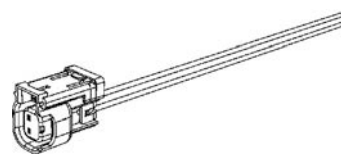

84-8M0062019

Use when the replacement of the entire harness is not necessary. Includes the fuel injector 2-pin female connector and 2 crimp splices.

Fits MCM 4.3L, 5.0L, 5.7L and 6.2L MPI engines fuel injector

PACKARD REPAIR KIT, 3-PIN, FEMALE

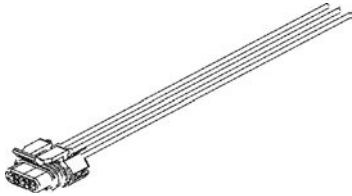

84-8M0062020

Use when the replacement of the entire harness is not necessary. Includes the Packard 3-pin female connector and 3 crimp splices.

Fits MCM 4.3L, 5.0L, 5.7L and 6.2L MPI engines ignition coil

CPS CRANK POSITION SENSOR REPAIR KIT, 3-PIN, FEMALE

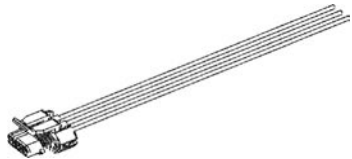

84-8M0062021

Use when the replacement of the entire harness is not necessary. Includes the Crank Position 3-pin female connector and 3 crimp splices.

Fits MCM V-8 engines with CPS

TMAP TEMPERATURE AND MANIFOLD AIR PRESSURE REPAIR KIT, 4-PIN, FEMALE

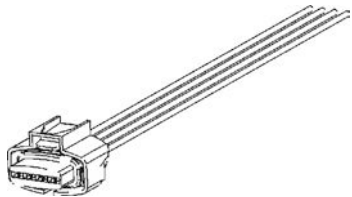

84-8M0062022

Use when the replacement of the entire harness is not necessary. Includes the TMAP 4-pin female connector and 4 crimp splices.

Fits MCM 4.3L, 5.0L, 5.7L and 6.2L MPI engines TMAP sensor

TRANSOM HARNESS REPAIR KIT, 16-PIN, MALE

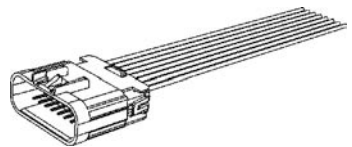

84-8M0062023

Use when the replacement of the entire harness is not necessary. Includes the Transom harness 16-pin male connector and 16 crimp splices.

Fits MCM MPI engines with harness connector

OIL PRESSURE SWITCH REPAIR KIT, 3-PIN, FEMALE

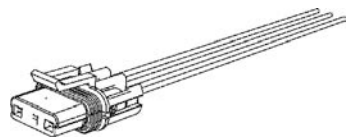

84-8M0062024

Use when the replacement of the entire harness is not necessary. Includes the Oil Pressure Switch harness 3-pin female connector and 3 crimp splices.

Fits MCM 3.0L TKS engines oil pressure switch

CAN 1/P & H RESISTOR REPAIR KIT, 10-PIN, MALE

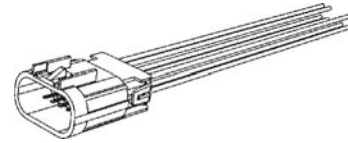

84-8M0062025

Use when the replacement of the entire harness is not necessary. Includes the 10 pin Can 1/P & H Resistor harness connector w/7 male pins and 7 crimp splices.

Fits MCM 8.2L DTS engines Can 1/P & H resistor

IAC REPAIR KIT, 2-PIN



8M0050085

As an alternative to replacing the complete engine harness, this service end is furnished with the necessary 2 bullet connectors to connect to the main engine harness.

Fits MCM MPI engines with mechanical throttle body. Also fits the 75-115hp. EFI FourStroke outboard (1B366823-2B094995)(Idle air control IAC).

COIL PORT REPAIR KIT, 4-PIN, FEMALE

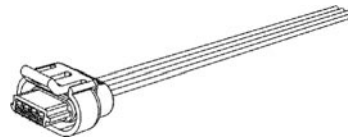

84-8M0062027

Use when the replacement of the entire harness is not necessary. Includes the Coil Port harness 2-pin female connector and 2 crimp splices.

Fits MCM 8.2L engines with mechanical throttle body

MERCURY® MERCUISER® FUEL SYSTEM

CARBURETOR REPAIR KITS

CARBURETOR REPAIR KIT



1397- 5831

For Rochester 2bbl. See application chart for specific models.

CARBURETOR REPAIR KIT



1397- 6367A 1

For Rochester 2bbl. See application chart for specific models.

CARBURETOR REPAIR KIT



1397- 8760

For Rochester 2bbl. See application chart for specific models.

CARBURETOR REPAIR KIT



823427A 1

For Rochester 2bbl.
Fits 1964-1983 MCM GM 4 & 6 cyl. Engines

CARBURETOR REPAIR KIT



3302-804845

Fits 1983-1986 MCM 120, 140, 470, 185, 200 & 898 engines with the older MerCarb 2 bbl. having the bottom fill accelerator pump cavity.

CARBURETOR REPAIR KIT



3302-804844002

Fits 1986-2016 MCM 4 cyl, V-6 & V-8 (305 & 350 cid) engines with the newer MerCarb 2bbl. having the current side fill accelerator pump cavity.

CARBURETOR REPAIR KIT



1396- 4656

Contains Adjustable Needles & Seats
For Holley 2bbl. See application chart for specific models.

CARBURETOR REPAIR KIT



823426A 1

For Rochester 4bbl. QuadraJet.
Fits 1969-1995 MCM 4 & 6 cyl. in-line, V-6 & V-8 (305, 350, 427, 454 & 502 cid) engines

MERCURY® MERCUISER®

MERCURY® MERCUISER® FUEL SYSTEM

CARBURETOR REPAIR KIT



8M0120193

For Weber 4bbl.
Fits 1987-1997 MCM/MIE/Tow Sports 350 Mag & 5.7L/LX engines with 9665 & 9781 Weber carbs. Also fits 1990-1997 MCM/MIE 454 Mag, 502 Mag, 7.4L & 8.2L engines.

CARBURETOR REPAIR KIT



8M0120192

For Weber 4bbl.
Fits 1987-1996 MCM/MIE/Tow Sports 350 Mag & 5.7L engines with 9661 & 9770 Weber carbs

CARBURETOR REPAIR KIT



8M0120196

For Weber 4bbl.
Fits 1992-1996 MCM 4.3LX (s/n 0D714370-0F802999)

CARBURETOR REPAIR KIT

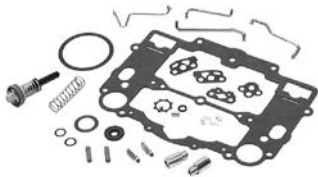

8M0120197

For Weber 4bbl.
Fits 1996-2002 MCM 4.3LH & LXH (s/n 0F803114-0M614999)

CARBURETOR REPAIR KIT

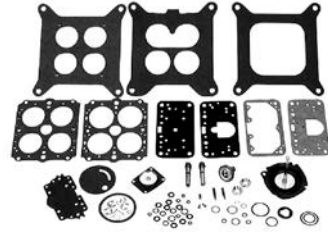

1396- 5238

Contains Adjustable Needles & Seats
For Holley 4bbl. See application chart for specific models.

CARBURETOR REPAIR KIT

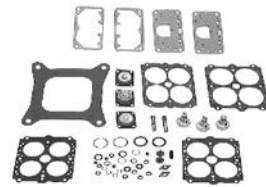

13220

For Holley 4bbl. See application chart for specific models.

CARBURETOR GASKET KITS

CARBURETOR GASKET KIT



3310-810929004

For MerCarb 2bbl.

MERCUISER FUEL FILTERS - CARBURETOR

CARBURETOR FUEL FILTER



1397- 8767T

For Rochester 2bbl. & 4bbl.
Priced individually, sold @ multiples of 2
Mercury Branded, Clamshell Package Point of Sale Packaged.

MERCURY® MERCUISER®

1397- 8767Q

For Rochester 2bbl. & 4bbl.
Priced individually, sold @ multiples of 2
Quicksilver Branded, Clamshell Package Point of Sale Packaged.

CARBURETOR FUEL FILTER



35- 53336T

For Rochester 2 & 4-barrel and MerCarb 2-barrel carburetors.
Priced individually, sold @ multiples of 2
Mercury Branded, Clamshell Package Point of Sale Packaged.

35- 53336Q

For Rochester 2 & 4-barrel and MerCarb 2-barrel carburetors.
Priced individually, sold @ multiples of 2
Quicksilver Branded, Clamshell Package Point of Sale Packaged.

CARBURETOR FUEL FILTER



35- 93568

For Holley 4bbl.

CARBURETOR AND REPAIR PARTS CHART

Carburetors

Model	CID/ # Cyl.	Year Range	Serial # Range	Original Carb P/N	Original Mfg. P/N Code / Model	Carb Repair Kit	Needle & Seat	Accel Pump	Replacement Carb
60	68/ L4	1965 - 1968	1887079 - 2049044	1342- 2565	MD135A	NLA	NLA	NLA	NLA
60	68/ L4	1965 - 1968	1887079 - 2049044	1342- 2564	MD134A	NLA	NLA	NLA	NLA
80	80/ L4	1966 - 1969	2049045 - 2851423	1346- 2770	RBS4394S C1/RBS	NLA	NLA	NLA	NLA
90	96/ L4	1970 - 1971	2851424 - 3225967	1351- 4263A 1	7040082 R2/2GC	823427A 1	N.S.S.	N.S.S.	NLA
90	96/ L4	1972	3225868 - 3226957	1351- 4263A 2	7041369 R2/2GC	823427A 1	N.S.S.	N.S.S.	NLA
110	153/ L4	1963 - 1966	1537370 - 2044033	1336- 2076	7036543 R2/2GC	NLA	N.S.S.	N.S.S.	NLA
120	153/ L4	1964 - 1968	1666601 - 2520424	1336- 2076	7036543 R2/2GC	NLA	N.S.S.	N.S.S.	NLA
120	153/ L4	1969 - 1972	2520425 - 3377340	1336- 3594A 1	7036543 R2/2GC	NLA	N.S.S.	N.S.S.	NLA
120	153/ L4	1972 - 1973	3377341 - 3770649	1351- 4263A 3	7041369 R2/2GC	823427A 1	N.S.S.	N.S.S.	NLA
120	153/ L4	1974 - 1975	3770650 - 4469865	1351- 5202A 1	7043182 R2/2GC	823427A 1	N.S.S.	N.S.S.	NLA
120	153/ L4	1976 - 1978	4469866 - 5192048	1351- 6065A 2	7044182 R2/2GC	823427A 1	N.S.S.	N.S.S.	NLA
120	153/ L4	1979 - 1982	5192049 - 6229717	1351- 7354A 1	17059054 R2/2GC	823427A 1	N.S.S.	N.S.S.	NLA
120	153/ L4	1983	6229718 - 6663797	1351- 8480A 2	17081060 R2/2GC	823427A 1	N.S.S.	NLA	NLA
120	153/ L4	1984	6663798 - 6853913	1389- 8490A 2	M2/MERCarb	3302- 804845	3302- 9407	3302- 9046	3310- 860070A 2
120	153/ L4	1985	6853914 - 0A492055	1389- 9350A 2	M2/MERCarb	3302- 804845	3302- 9407	3302- 9046	3310- 860070A 2
120	153/ L4	1986	0A492056 - 0B531853	1389- 9562A 1	M2/MERCarb	3302- 804844002	3302- 9407	3302- 9655 1	3310- 860070A 2
2.5L	153/ L4	1987 - 1989	0B531854 - 0C853255	3310-806077A 2	M2/MERCarb	3302- 804844002	3302- 9407	3302- 9655 1	3310- 860070A 2
140	181/ L4	1968 - 1969	2508261 - 2816416	1351- 3635A 1	7036646 R/2GC	823427A 1	N.S.S.	N.S.S.	NLA
140	181/ L4	1970	2816417 - 2911439	1351- 4032A 1	7040080 R/2GC	823427A 1	N.S.S.	N.S.S.	NLA
140	181/ L4	1970 - 1973	2911440 - 3771644	1351- 4293A 1	7040084 R/2GC	823427A 1	N.S.S.	N.S.S.	NLA
140	181/ L4	1974 - 1978	3771645 - 5157668	1351- 5203A 1	7043184 R/2GC	823427A 1	N.S.S.	N.S.S.	NLA
140	181/ L4	1979 - 1982	5157669 - 6229717	1351- 7355A 1	17059052 R/2GC	823427A 1	N.S.S.	N.S.S.	NLA
140	181/ L4	1983	6229718 - 6671328	1351- 8480A 2	17081060 R/2GC	823427A 1	N.S.S.	NLA	NLA
140	181/ L4	1984	6671329 - 6852269	1389- 8490A 2	M2/MERCarb	3302- 804845	3302- 9407	3302- 9046	3310- 860070A 2
140	181/ L4	1985	6852270 - 0A484072	1389- 9350A 2	M2/MERCarb	3302- 804845	3302- 9407	3302- 9046	3310- 860070A 2
140	181/ L4	1986	0A484073 - 0B450800	1389- 9562A 1	M2/MERCarb	3302- 804844002	3302- 9407	3302- 9655 1	3310- 860070A 2
3.0L	181/ L4	1987 - 1989	0B450801 - 0C856556	3310-806077A 2	M2/MERCarb	3302- 804844002	3302- 9407	3302- 9655 1	3310- 860070A 2

Not all parts listed are available for the European, C.I.S., Africa and Middle East Markets.
For more information, please contact your local Mercury, Mariner, MerCruiser or Quicksilver Office.

MERCURY® MERCURISER® FUEL SYSTEM

MERCURY® MERCURISER®

Model	CID/ # Cyl.	Year Range	Serial # Range	Original Carb P/N	Original Mfg. P/N Code / Model	Carb Repair Kit	Needle & Seat	Accel Pump	Replacement Carb
3.0L	181/ L4	1990	0C856559 - 0D447414	1389-815396A 2	M2/MERCARB	3302 804844002	3302-804689	3302- 9655 1	3310-860070A 2
3.0L	181/ L4	1991 - 1993	0D447415 - 0D836075	1389-806077A 2	M2/MERCARB	3302 804844002	3302-804689	3302- 9655 1	3310-860070A 2
3.0L	181/ L4	1993 - 1994	0D836076 - 0F603999	1389-806078A 2	M2/MERCARB	3302 804844002	3302-804689	3302- 9655 1	3310-860070A 2
3.0L	181/ L4	1998 - 2002	0L010042 - 0M385672	3310-807504A 1	M2/MERCARB	3302 804844002	3302-804689	3302- 9655 1	3310-8M0045397
3.0L	181/ L4	2003 - 2004	0M385673 - 0W301999	3310-864940A01	M2/MERCARB	3302 804844002	3302-804689	3302- 9655 1	3310-8M0045397
3.0L	181/ L4	2004 - 2016	0W302000 - 2A506300	3310-866140A02	M2/MERCARB/TKS	3302 804844002	3302-804689	3302- 9655 1	3310-8M0084193
3.0LX	181/ L4	1990 - 1997	0C856559 - 0K999999	1389-815397A 2	M2/MERCARB	3302 804844002	3302-804689	3302- 9655 1	3310-8M0045397
3.0LX	181/ L4	1990 - 1997	0C856559 - 0K999999	3310-805924A 2	M2/MERCARB	3302 804844002	3302-804689	3302- 9655 1	3310-8M0045397
165 (4 cyl.)	224/ L4	1987	0B434941 - 0B774251	1389- 9564A 1	M2/MERCARB	3302 804844002	3302- 9407	3302- 9655 1	3310-860071A 2
170	224/ L4	1985 - 1989	6916779 - 0B434940	1389- 9564A 1	M2/MERCARB	3302 804844002	3302- 9407	3302- 9655 1	3310-860071A 2
180	224/ L4	1987	0B436391 - 0B775248	1347- 9142A 2	17083522 R4/4ME	823426A 1	1397- 8548	NLA	NLA
190 (4 cyl.)	224/ L4	1985 - 1986	6916779 - 0B436390	1347- 9142A 2	17083522 R4/4ME	823426A 1	1397- 8548	NLA	NLA
3.7L	224/ L4	1988 - 1989	0B774252 and up	1389- 9564A 1	M2/MERCARB	3302 804844002	3302- 9407	3302- 9655 1	3310-860071A 2
3.7LX	224/ L4	1988 - 1989	0B775249 and up	1347- 9142A 2	17083522 R4/4ME	823426A 1	1397- 8548	N.L.A.	N.L.A.
470	224/ L4	1976 - 1984	4208730 - 6916778	1376- 5990A 1	17057132 R2/2GC	1397- 6367A 1	N.S.S.	N.S.S.	3310-860071A 4(10)
470	224/ L4	1983 - 1984	6218037 - 6916778	1389- 8489A 5	M2/MERCARB	3302 804845	3302-804689	3302- 9046	3310-860071A 2(9)
485	224/ L4	1980 - 1982	5685394 - 6218036	1376- 5990A 1	17057132 R2/2GC	1397- 6367A 1	N.S.S.	N.S.S.	3310-860071A 4
488	224/ L4	1983 - 1984	6170297 - 6916778	1347- 8460A 3	17081299 R4/4ME	823426A 1	NLA	NLA	NLA
140 (6 cyl.)	194/ L6	1963	1538930 - 1725960	1338- 2161	7025638 R1/BC	NLA	N.S.S.	N.S.S.	NLA
140 (6 cyl.)	194/ L6	1963	1538930 - 1725960	1338- 2166	7025662 R1/B	NLA	N.S.S.	N.S.S.	NLA
150	230/ L6	1964 - 1966	1666495 - 1823489	1338- 2428	7024180 R1/BC	NLA	N.S.S.	N.S.S.	NLA
150	230/ L6	1964 - 1966	1666495 - 1823489	1338- 2431	7024181 R1/B	NLA	N.S.S.	N.S.S.	NLA
150	230/ L6	1964 - 1966	1823490 - 1830151	1338- 2608	7025183 R1/BC	NLA	N.S.S.	N.S.S.	NLA
150	230/ L6	1964 - 1966	1823490 - 1830151	1338- 2609	7025184 R1/B	NLA	N.S.S.	N.S.S.	NLA
150	230/ L6	1964 - 1966	1830152 - 2048046	1338- 2633	7025188 R2/2GC	823427A 1	N.S.S.	N.S.S.	NLA
160	250/ L6	1967 - 1968	2048022 - 2492035	1338- 2991	7026088 R2/2GC	823427A 1	N.S.S.	N.S.S.	NLA
160	250/ L6	1969	2492036 - 2770031	1351- 3635A 1	7036646 R2/2GC	823427A 1	N.S.S.	N.S.S.	NLA
165 (6 cyl.)	250/ L6	1970 - 1972	2770032 - 3354791	1351- 4282A 1	7040083 R2/2GC	823427A 1	N.S.S.	N.S.S.	NLA
165 (6 cyl.)	250/ L6	1972 - 1973	3354702 - 3774864	1351- 4871A 1	7042183 R2/2GC	823427A 1	N.S.S.	N.S.S.	NLA
165 (6 cyl.)	250/ L6	1974 - 1978	3774865 - 5178958	1351- 5204A 1	7043183 R2/2GC	823427A 1	N.S.S.	N.S.S.	NLA
165 (6 cyl.)	250/ L6	1979 - 1981	5178959 - 5813433	1351- 7356A 1	17059050 R2/2GC	823427A 1	N.S.S.	N.S.S.	NLA
200 (6 cyl.)	292/ L6	1969	2453769 - 2494935	1347- 3237A 2	7037082 R4/4MV	823426A 1	NLA	NLA	NLA
200 (6 cyl.)	292/ L6	1969	2494936 - 2712072	1347- 3237A 4	7037082 R4/4MV	823426A 1	NLA	NLA	NLA
185 (4 bbl.)	229/ V-6	1993 - 1994	6330183 - 6919655	3300- 8886A 2	17083515 R4/4ME	823426A 1	1397- 8548	NLA	NLA
175	262/ V-6	1987	0B527955 - 0B773242	3304- 9565A 1	M2/MERCARB	3302 804844002	3302- 9407	3302- 9655 1	3310-807764A 1
185	262/ V-6	1985 - 1986	0A331455 - 0B527954	3304- 9353A 2	M2/MERCARB	3302 804845	3302- 9407	3302- 9046	3310-807764A 1
205	262/ V-6	1985 - 1987	0A331455 - 0B775129	3304- 9354A 2	17084516 R4/4MV	823426A 1	1397- 8548	NLA	NLA
4.3L	262/ V-6	1988 - 1992	0B773243 - 0D714106	3304- 9565A 1	M2/MERCARB	3302 804844002	3302- 9407	3302- 9655 1	3310-807764A 1
4.3L	262/ V-6	1992 - 1993	0D714107 - 0F000877	3304- 9565A 7	M2/MERCARB	3302 804844002	3302- 9407	3302- 9655 1	3310-807764A 1
4.3L	262/ V-6	1993 - 1995	0F000878 - 0F601126	3310-806080A 2	M2/MERCARB	3302 804844002	3302-804689	3302- 9655 1	3310-807764A 1
4.3L	262/ V-6	1993 - 1995	0F000878 - 0F601126	3310-806972A 1	M2/MERCARB	3302 804844002	3302-804689	3302- 9655 1	3310-807764A 1
4.3L	262/ V-6	1996 - 2002	0F601127 - 0M614999	3310-807764A 1	M2/MERCARB	3302 804844002	3302-804689	3302- 9655 1	3310-807764A 1
4.3L	262/ V-6	2002 - 2004	0M615000 - 0W300012	3310-864941A01	M2/MERCARB	3302 804844002	3302-804689	3302- 9655 1	NLA
4.3L	262/ V-6	2000 - 2004	0L619000 - 0W300012	3310-864941A01	M2/MERCARB	3302 804844002	3302-804689	3302- 9655 1	NLA(17)
4.3L	262/ V-6	2004 - 2015	0W300013 - 2A454127	3310-866141A02	M2/MERCARB/TKS	3302 804844002	3302-804689	3302- 9655 1	3310-8M0084194
4.3LH	262/ V-6	1998 - 2002	0L010044 - 0M614999	3310-807826A 1	9666 WEBER	8M0120197	823727	8M0120191	NLA
4.3LX	262/ V-6	1988 - 1991	0B775130 - 0D714369	3304- 9354A 2	17084516 R4/4MV	823426A 1	1397- 8548	NLA	NLA
4.3LX	262/ V-6	1992 - 1996	0D714370 - 0F802999	3310-818660A 1	9600 WEBER	8M0120196	823727	8M0120191	NLA
4.3LXH	262/ V-6	1996 - 1997	0F803114 - 0K999999	3310-807826A 1	9666 WEBER	8M0120197	823727	8M0120191	NLA

MERCURY® MERCUISER® FUEL SYSTEM

MERCURY® MERCUISER®

Model	CID/ # Cyl.	Year Range	Serial # Range	Original Carb P/N	Original Mfg. P/N Code / Model	Carb Repair Kit	Needle & Seat	Accel Pump	Replacement Carb
215 MCM / MIE (Ford)	302/ V-8	1970 - 1972	2781153 - 3385720	1356- 4066	C9FF9510E H4/4160	1396- 5238	NLA	NLA	NLA
225 MCM / MIE (Ford)	302/ V-8	1973 - 1974	3385721 - 4166999	1356- 5155	D2JL9510C H4/4160	1396- 5238	NLA	NLA	NLA
888 (Ford)	302/ V-8	1971 - 1977	3108723 - 4887829	1356- 4642	D1JJ95108 H2/2300	1396- 4656	NLA	NLA	NLA
888 (Ford)	302/ V-8	1971 - 1977	3108723 - 4887829	1376- 5659A 1	7044185 R2/2GC	1397- 5831	N.S.S.	N.S.S.	NLA(10)
190	283/ V-8	1963 - 1964	1564539 - 1730903	1339- 2249	7026358 R2/2GC	NLA	N.S.S.	N.S.S.	NLA
198 MIE	305/ V-8	1977	4776402 - 4931099	1376- 6491A 1	17057139 R2/2GC	1397- 5831	N.S.S.	N.S.S.	3310- 861080A 1
200	305/ V-8	1985 - 1986	6899058 - 0A482026	1389- 8488A 2	M2/MERCarb	3302- 804845	3302- 9407	3302- 9046	3310- 861080A 1
200	305/ V-8	1986 - 1987	0A482027 - 0B525981	1389- 9563A 1	M2/MERCarb	3302- 804844002	3302- 9407	3302- 9655 1	3310- 861080A 1
200	305/ V-8	1987	0B525982 - 0B774444	1389- 9670A 2	M2/MERCarb	3302- 804844002	3302- 804689	3302- 9655 1	3310- 807312A 1
228	305/ V-8	1977 - 1978	4765100 - 5069430	1347- 6427A 1	17057282 R4/4MV	823426A 1	N.S.S.	N.S.S.	9661A 3
228	305/ V-8	1978 - 1981	5069431 - 6021783	1347- 7361A 1	17059292 R4/4MV	823426A 1	N.S.S.	N.S.S.	9661A 3
228	305/ V-8	1982	6021784 - 6218461	1347- 8296A 4	17080565 R4/4MV	823426A 1	1397- 8548	NLA	9661A 3
228	305/ V-8	1982 - 1984	6218462 - 6899268	1347- 9661A 3	17080565 R4/4MV	823426A 1	1397- 8548	NLA	9661A 3
228 MIE	305/ V-8	1977 - 1978	4765100 - 5069430	1347- 6438A 1	17057283 R4/4MV	823426A 1	N.S.S.	N.S.S.	9661A 3
228 MIE	305/ V-8	1978 - 1982	5069431 - 6040745	1347- 7364A 1	17059291 R4/4MV	823426A 1	N.S.S.	N.S.S.	9661A 3
228 TR	305/ V-8	1977 - 1978	4765100 - 5069430	1347- 6438A 1	17057283 R4/4MV	823426A 1	N.S.S.	N.S.S.	9661A 3
230	305/ V-8	1985 - 1987	6899269 - 0B773739	1347- 9661A 3	17080565 R4/4MV	823426A 1	1397- 8548	NLA	9661A 3
230 MIE	305/ V-8	1982 - 1987	6040746 - 0B788151	1347- 8290A 1	17080564 R4/4MV	823426A 1	1397- 8548	NLA	9661A 3
5.0L	305/ V-8	1988 - 1995	0B774445 - 0F600999	1389- 9670A 2	M2/MERCarb	3302- 804844002	3302- 804689	3302- 9655 1	3310- 807312A 1
5.0L (Gen +)	305/ V-8	1998 - 2002	0L015751 - 0M599999	3310-861448A 1	M2/MERCarb	3302- 804844002	3302- 804689	3302- 9655 1	3310- 864942A01
5.0L (Gen +)	305/ V-8	2002 - 2004	0M600000 - 0W300009	3310-864942A01	M2/MERCarb	3302- 804844002	3302- 804689	3302- 9655 1	3310- 864942A01
5.0L (Gen +)	305/ V-8	2000 - 2004	0L619000 - 0W300009	3310-864942A01	M2/MERCarb	3302- 804844002	3302- 804689	3302- 9655 1	NLA(17)
5.0L (Gen +)	305/ V-8	2004 - 2009	0W300010 - 1A607561	3310-866142A03	M2/MERCarb/TKS	3302- 804844002	3302- 804689	3302- 9655 1	3310- 866142A04
5.0LX	305/ V-8	1988 - 1995	0B773740 - 0F600999	1347- 9661A 3	17080565 R4/4MV	823426A 1	1397- 8548	NLA	9661A 3
898	305/ V-8	1977	4762210 - 6021383	1376- 6491A 1	17057139 R2/2GC	1397- 5831	N.S.S.	N.S.S.	3310- 861080A 1
898	305/ V-8	1982	6021384 - 6218461	1376- 8295A 3	17080350 R2/2GC	1397- 8760	N.S.S.	N.S.S.	3310- 861080A 1
898	305/ V-8	1983 - 1984	6218462 - 6899057	1389- 8488A 2	M2/MERCarb	3302- 804845	3302- 9407	3302- 9046	3310- 861080A 1
225 MCM / MIE (GM)	327/ V-8	1963 - 1969	1539620 - 2694014	1337- 2103(1)	7025564 R4/4GC	NLA	N.S.S.	N.S.S.	NLA
225 MCM / MIE (GM)	327/ V-8	1963 - 1969	1539620 - 2694014	1337- 2604(1)	7025756 R4/4GC	NLA	N.S.S.	N.S.S.	NLA
225 MCM / MIE (GM)	327/ V-8	1963 - 1969	1539620 - 2694014	1347- 3353(1)	7037082 R4/4MV	NLA	N.S.S.	N.S.S.	NLA
225 MCM / MIE (GM)	327/ V-8	1963 - 1969	1539620 - 2694014	1347- 3237A 3(4)	7037082 R4/4MV	NLA	N.S.S.	N.S.S.	NLA
250	350/ V-8	1977	4768000 - 4908849	1347- 3353(1)	7037082 R4/4MV	NLA	N.S.S.	N.S.S.	NLA
250	350/ V-8	1977	4768000 - 4908849	1347- 3237A 3(4)	7037082 R4/4MV	NLA	N.S.S.	N.S.S.	NLA
255	350/ V-8	1975 - 1976	4175500 - 4767999	1347- 5732A 1	7044291 R4/4MV	823426A 1	N.S.S.	N.S.S.	NLA
255 MIE (GM)	350/ V-8	1975 - 1978	4175500 - 4924564	1347- 5732A 1	7044291 R4/4MV	823426A 1	N.S.S.	N.S.S.	NLA
255 MIE (GM)	350/ V-8	1978	4924565 - 5195908	1347- 7062A 1	17057295 R4/4MV	823426A 1	N.S.S.	N.S.S.	NLA
255 MIE (GM)	350/ V-8	1979 - 1980	5195909 - 5907057	1347- 7365A 1	17059289 R4/4MV	823426A 1	N.S.S.	N.S.S.	NLA
260	350/ V-8	1978	4908850 - 5060805	1347- 6492A 1	17057298 R4/4MV	823426A 1	N.S.S.	N.S.S.	NLA
260	350/ V-8	1978 - 1982	5060806 - 6024393	1347- 7362A 1	17059288 R4/4MV	823426A 1	N.S.S.	N.S.S.	NLA
260	350/ V-8	1982 - 1987	6024393 - 0B525981	1347- 8292A 4	17080561 R4/4MV	823426A 1	1397- 8548	NLA	NLA
260	350/ V-8	1987	0B525982 - 0B773304	1347- 9662A 4	17080561 R4/4MV	823426A 1	1397- 8548	NLA	NLA
260 MIE	350/ V-8	1981 - 1987	5907058 - 0B522505	1347- 8289A 1	17080562 R4/4MV	823426A 1	1397- 8548	NLA	NLA
260 MIE	350/ V-8	1987	0B522506 - 0B788151	1347- 9662A 4	17080561 R4/4MV	823426A 1	1397- 8548	NLA	NLA
270 MCM/MIE	350/ V-8	1969 - 1972	2851074 - 3385720	1347- 4180A 1	7029285 R4/4MV	823426A 1	N.S.S.	N.S.S.	NLA
280 TRS	350/ V-8	1975	4176250 - 4176468	1347- 4179A 2	7040283 R4/4MV	823426A 1	N.S.S.	N.S.S.	NLA
280 TRS	350/ V-8	1975 - 1976	4176469 - 4770199	1347- 5981A 1	7044290 R4/4MV	823426A 1	N.S.S.	N.S.S.	NLA
300 MR/TRS	350/ V-8	1985 - 1986	6668677 - 0B430367	1347- 7498A 7	17059280 R4/4MV	823426A 1	N.S.S.	N.S.S.	NLA
350 Mag Alpha	350/ V-8	1986 - 1991	0A635178 - 0D617327	1347- 8289A 1	17080562 R4/4MV	823426A 1	1397- 8548	N.L.A.	NLA
350 Mag Alpha	350/ V-8	1992 - 1995	0D617328 - 0F600999	3310-806970A 1	9770SA WEBER	8M0120192	811534	8M0120191	NLA
350 Mag Alpha	350/ V-8	1996 - 1997	0F601000 - 0K999999	3310-807262A 2	9781 WEBER	8M0120193	811534	8M0120191	NLA

Not all parts listed are available for the European, C.I.S., Africa and Middle East Markets.
For more information, please contact your local Mercury, Mariner, MerCruiser or Quicksilver Office.

MERCURY® MERCURISER® FUEL SYSTEM

MERCURY® MERCURISER®

Model	CID/ # Cyl.	Year Range	Serial # Range	Original Carb P/N	Original Mfg. P/N Code / Model	Carb Repair Kit	Needle & Seat	Accel Pump	Replacement Carb
350 Mag Ski	350/ V-8	1991 - 1996	0D505450 - 0K040399	3310-806970A 1(6)	9770SA WEBER	8M0120192	811534	8M0120191	NLA(11)
350 Mag Ski	350/ V-8	1991 - 1997	0D505450 - 0K999999	3310-807262A 2(6)	9781 WEBER	8M0120193	811534	8M0120191	NLA(11)
350 Mag Ski	350/ V-8	1997	0K040400 - 0K999999	3310-860371A 1(13)	9781SB WEBER	8M0120193	811534	8M0120191	NLA(12)
5.7L (2 bbl.)	350/ V-8	1996 - 1997	0F601000 - 0K999999	3310-807312A 1	M2/MERCARB	3302-804844002	3302-804689	3302- 9655 1	3310-807312A 1
5.7L (Gen +) (2 bbl.)	350/ V-8	1998 - 2002	0L010037 - 0M599999	3310-861245A 1	M2/MERCARB	3302-804844002	3302-804689	3302- 9655 1	3310-864943A01
5.7L (Gen +) (2 bbl.)	350/ V-8	2002 - 2004	0M600000 - 0W300754	3310-864943A01	M2/MERCARB	3302-804844002	3302-804689	3302- 9655 1	3310-864943A01
5.7L (Gen +) (2 bbl.)	350/ V-8	2000 - 2004	0L015751 - 0W300754	3310-864943A01	M2/MERCARB	3302-804844002	3302-804689	3302- 9655 1	N.L.A.(17)
5.7L (Gen +) (2 bbl.)	350/ V-8	2004 - 2009	0W300755 - 1A600136	3310-866143A03	M2/MERCARB/TKS	3302-804844002	3302-804689	3302- 9655 1	3310-866143A03
5.7L Alpha	350/ V-8	1988 - 1993	0B773305 - 0F000454	1347- 9662A 4	17080561 R4/4MV	823426A 1	1397- 8548	NLA	NLA
5.7L Alpha	350/ V-8	1993 - 1994	0F000455 - 0F273497	3310-805484A 1	9661 WEBER	8M0120192	811534	NLA	NLA
5.7L Alpha	350/ V-8	1993 - 1994	0F000455 - 0F273497	3310-806761A 1	9665S WEBER	8M0120193	811534	NLA	NLA
5.7L Alpha	350/ V-8	1994 - 1995	0F273498 - 0F600999	3310-806761A 3	9665S WEBER	8M0120193	811534	8M0120191	NLA
5.7L Bravo (w/o High Rise Intake)	350/ V-8	1988 - 1991	0B773305 - 0D617327	1347- 9662A 4	17080561 R4/4MV	823426A 1	1397- 8548	NLA	NLA
5.7L Bravo (w/ High Rise Intake)	350/ V-8	1988 - 1991	0B773305 - 0D617327	1347- 8289A 1	17080562 R4/4MV	823426A 1	1397- 8548	NLA	NLA
5.7L Bravo	350/ V-8	1992 - 1995	0D617328 - 0F600999	3310-806970A 1	9770SA WEBER	8M0120192	811534	8M0120191	NLA
5.7L MIE	350/ V-8	1988 - 1992	0B788152 - 0D715493	1347- 9662A 4	17080561 R4/4MV	823426A 1	1397- 8548	NLA	NLA
5.7L MIE	350/ V-8	1992 - 1994	0D715494 - 0F349999	3310-806761A 2(14)	9665S WEBER	8M0120193	811534	NLA	NLA
5.7L MIE	350/ V-8	1994	0F025000 - 0F349299	3310-805484A 1(8)	9661 WEBER	8M0120192	811534	NLA	NLA
5.7L MIE	350/ V-8	1995	0F349300 - 0F622099	3310-806761A 3	9665S WEBER	8M0120193	811534	8M0120191	NLA
5.7L MIE	350/ V-8	1996 - 1997	0F622100 - 0K999999	3310-807262A 2	9781 WEBER	8M0120193	811534	8M0120191	NLA
5.7L MIE (2 bbl.)	350/ V-8	1998 - 2002	0L002003 - 0M316999	3310-861245A 1	M2/MERCARB	3302-804844002	3302-804689	3302- 9655 1	3310-864943A01
5.7L MIE (2 bbl.)	350/ V-8	2002 - 2004	0M317000 - 0W090899	3310-864943A01	M2/MERCARB	3302-804844002	3302-804689	3302- 9655 1	3310-864943A01
5.7L MIE (2 bbl.)	350/ V-8	2000 - 2004	0L390600 - 0W090899	3310-864943A01	M2/MERCARB	3302-804844002	3302-804689	3302- 9655 1	N.L.A.(17)
5.7L MIE (2 bbl.)	350/ V-8	2004 - 2010	0W090900 - 1A092388	3310-866143A03	M2/MERCARB/TKS	3302-804844002	3302-804689	3302- 9655 1	3310-866143A03
5.7L Ski	350/ V-8	1985 - 1987	0A338553 - 0B514626	1347- 9415T	17085013 R4/4MV	823426A 1	1397- 8548	NLA	9415T
5.7L Ski	350/ V-8	1987 - 1995	0B514627 - 0F775199	3310-806761A 2	9665S WEBER	8M0120193	811534	NLA	NLA
5.7L Ski	350/ V-8	1987 - 1995	0F450000 - 0F775199	3310-805484A 1	9661 WEBER	8M0120192	811534	8M0120191	NLA
5.7L Ski (2 bbl.)	350/ V-8	1996 - 1997	0F775200 - 0K999999	3310-807312A 1	M2/MERCARB	3302-804844002	3302-804689	3302- 9655 1	3310-807312A 1
5.7L Ski (Gen +) (2 bbl.)	350/ V-8	1998 - 2002	0L002005 - 0M316999	3310-861245A 1	M2/MERCARB	3302-804844002	3302-804689	3302- 9655 1	3310-864943A01
5.7L Ski (Gen +) (2 bbl.)	350/ V-8	2002 - 2004	0M317000 - 0W090899	3310-864943A01	M2/MERCARB	3302-804844002	3302-804689	3302- 9655 1	3310-864943A01
5.7L Ski (Gen +) (2 bbl.)	350/ V-8	2000 - 2004	0L390600 - 0W090899	3310-864943A01	M2/MERCARB	3302-804844002	3302-804689	3302- 9655 1	N.L.A.(17)
5.7L Ski (Gen +) (2 bbl.)	350/ V-8	2004 - 2011	0W090900 - 1A092837	3310-866143A03	M2/MERCARB/TKS	3302-804844002	3302-804689	3302- 9655 1	3310-866143A03
5.7LX (4 bbl.)	350/ V-8	1996 - 1997	0F601000 - 0K999999	3310-807262A 2	9781 WEBER	8M0120193	811534	8M0120191	NLA
233 MCM & MIE (Ford)	351/ V-8	1975 - 1977	4173000 - 4465029	1376- 5744A 1	7044187 R2/2GC	1397- 5831	N.S.S.	N.S.S.	NLA
233 MCM & MIE (Ford)	351/ V-8	1975 - 1977	4465030 - 4902304	1376- 6152A 1	17056197 R2/2GC	1397- 5831	N.S.S.	N.S.S.	NLA
255 MCM/MIE (Ford)	351/ V-8	1973 - 1974	3258728 - 4175499	1356- 5169	D2JL9510E H4/4160	NLA	NLA	NLA	NLA
325 MCM/MIE	427/ V-8	1969 - 1970	2278747 - 3042730	1347- 3342(1)	7027080 R4/4MV	823426A 1	N.S.S.	N.S.S.	NLA
325 MCM/MIE	427/ V-8	1971 - 1972	3042731 - 3780449	1347- 4533A 1(1)	7041831 R4/4MV	823426A 1	N.S.S.	N.S.S.	NLA
325 MCM/MIE	427/ V-8	1969 - 1972	2278747 - 3780449	1347- 3689A 1(4)	7029280 R4/4MV	823426A 1	N.S.S.	N.S.S.	NLA
330 MCM	454/ V-8	1977 - 1978	4623115 - 5027230	1347- 6493A 1	17057287 R4/4MV	823426A 1	N.S.S.	N.S.S.	NLA
330 MCM	454/ V-8	1977 - 1981	5027231 - 6083144	1347- 7363A 1	17059290 R4/4MV	823426A 1	N.S.S.	N.S.S.	NLA
330 MCM	454/ V-8	1982 - 1987	6083145 - 0B816540	1347- 8291A 3	17080563 R4/4MV	823426A 1	N.S.S.	N.S.S.	NLA
330 MIE	454/ V-8	1977 - 1978	4623115 - 5226384	1347- 6493A 1	17057287 R4/4MV	823426A 1	N.S.S.	N.S.S.	NLA
330 MIE	454/ V-8	1979 - 1980	5226385 - 5889913	1347- 7366A 1	17059287 R4/4MV	823426A 1	N.S.S.	N.S.S.	NLA
340 MIE	454/ V-8	1981 - 1987	5889914 - 0D788365	1347- 8288A 1	17080560 R4/4MV	823426A 1	1397- 8548	NLA	NLA
370	454/ V-8	1978 - 1987	4179554 - 0B714586	1347- 7498A 2	17059280 R4/4MV	823426A 1	N.S.S.	N.S.S.	NLA
400	454/ V-8	1980 - 1986	4179554 - 0B457644	1347- 7498A 2	17059280 R4/4MV	823426A 1	N.S.S.	N.S.S.	NLA
420	454/ V-8	1987 - 1989	0A398941 - 0B622418	13549A 4	H4	13220	N.S.S.	NLA	NLA
425	454/ V-8	1990 - 1993	0B622419 - 0D937011	13549A 4	H4	13220	N.S.S.	NLA	NLA
440	454/ V-8	1983 - 1986	4179554 - 0B485220	1393- 8862A 1	H4	13220	N.S.S.	N.S.S.	NLA

MERCURY® MERCUISER® FUEL SYSTEM

MERCURY® MERCUISER®

Model	CID/ # Cyl.	Year Range	Serial # Range	Original Carb P/N	Original Mfg. P/N Code / Model	Carb Repair Kit	Needle & Seat	Accel Pump	Replacement Carb
450	454/ V-8	1995 - 1996	0F347100 - 0F347277	13549A14	H4	13220	N.S.S.	NLA	NLA
454 Mag Alpha	454/ V-8	1986 - 1988	0A631894 - 0B785148	1347- 8291A 3	17080563 R4/4MV	823426A 1	1397- 8548	NLA	NLA
454 Mag Bravo	454/ V-8	1988 - 1992	0B721206 - 0D805068	1347- 7498A 2	17059280 R4/4MV	823426A 1	N.S.S.	N.S.S.	NLA
454 Mag Bravo	454/ V-8	1992 - 1994	0D805069 - 0F304999	3310-806755A 1	9779 WEBER	8M0120193	811534	NLA	NLA
454 Mag Bravo	454/ V-8	1995 - 1997	0F305000 - 0K999999	3310-806755A 2	9779 WEBER	8M0120193	811534	NLA	NLA
525 SC	454/ V-8	1991 - 1995	0D456000 - 0F348963	12377A 5	H4	N.L.A.	N.S.S.	N.S.S.	NLA(2)
525 SC	454/ V-8	1991 - 1999	0D456000 - 0L415623	12377A 6	H4	N.L.A.	N.S.S.	N.S.S.	NLA(3)
7.4L Bravo I/II	454/ V-8	1988 - 1991	0B771113 - 0D603117	1347- 8291A 3	17080563 R4/4MV	823426A 1	1397- 8548	NLA	NLA
7.4L Bravo I/II	454/ V-8	1992 - 1994	0D603118 - 0F351999	3310-806969A 2	9780 WEBER	8M0120193	811534	NLA	NLA
7.4L Bravo I/II	454/ V-8	1995 - 1997	0F352000 - 0K999999	3310-806969A 1	9780 WEBER	8M0120193	811534	NLA	3310-8M0047212
7.4L/Bravo III	454/ V-8	1993 - 1996	0D838819 - 0F800699	3310-806755A 2	9779 WEBER	8M0120193	811534	NLA	NLA
7.4L/Bravo III	454/ V-8	1996 - 1997	0F800700 - 0K999999	3310-806969A 1	9780 WEBER	8M0120193	811534	NLA	3310-8M0047212
7.4L MIE	454/ V-8	1988 - 1992	5889914 - 0D715493	1347- 8288A 1	17080560 R4/4MV	823426A 1	1397- 8548	NLA	NLA
7.4L MIE with Hurth	454/ V-8	1992 - 1994	0D715494 - 0F349999	3310-806969A 2	9780 WEBER	8M0120193	811534	NLA	NLA
7.4L MIE with B/W	454/ V-8	1992 - 1994	0D715494 - 0F349999	3310-806969A 3	9780 WEBER	8M0120193	811534	NLA	NLA
7.4L MIE	454/ V-8	1995 - 1997	0F350000 - 0K999999	3310-806969A 1	9780 WEBER	8M0120193	811534	NLA	3310-8M0047212
460	482/ V-8	1983 - 1986	4179554 - 0B485220	1393- 8862A 1	H4	13220	N.S.S.	N.S.S.	NLA
465	502/ V-8	1990 - 1992	0C849992 - 0F213244	N.L.A.	H4	13220	N.S.S.	NLA	NLA(2)
465	502/ V-8	1990 - 1992	0C849992 - 0F213244	N.L.A.	H4	13220	N.S.S.	NLA	NLA(3)
500	502/ V-8	1994 - 1995	0F213293 - 0F615766	13549A12	H4	13220	N.S.S.	NLA	NLA(3)
500	502/ V-8	1996 - 1998	0F615767 - 0L001772	13549A15	H4	13220	N.S.S.	NLA	NLA(3)
500 (Gen +)	502/ V-8	1999	0L414639 - 0L601036	13549T21	H4	13220	N.S.S.	NLA	NLA(3)
502 Mag	502/ V-8	1990 - 1992	0C878221 - 0D824588	1347-814623A 2	17089112 R4/4MV	823426A 1	1397- 8548	NLA	NLA
502 Mag	502/ V-8	1992 - 1993	0D824589 - 0F114528	3310-806971A 1	9782 WEBER	8M0120193	811534	NLA	NLA
575	502/ V-8	1986 - 1992	0A677429 - 0D763716	12377A 2	H4	NLA	N.S.S.	N.S.S.	NLA
600 SC	502/ V-8	1991 - 2000	0D456489 - 0L601186	3312-821030A15	H4	NLA	N.S.S.	N.S.S.	NLA(7)
600 SC	502/ V-8	1991 - 2000	0D456489 - 0L601186	3312-821030A16	H4	NLA	N.S.S.	N.S.S.	NLA(5)
8.2L MIE	502/ V-8	1990 - 1992	0C878221 - 0D857199	1347-814623A 2	17089112 R4/4MV	823426A 1	1397- 8548	NLA	NLA
8.2L MIE	502/ V-8	1990 - 1992	0C878221 - 0D857199	3310-817693A 1	9774 WEBER	8M0120193	811534	NLA	NLA
8.2L MIE	502/ V-8	1993 - 1996	0D857200 - 0F819619	3310-806971A 1	9782 WEBER	8M0120193	811534	NLA	NLA
500 Bulldog	540/ V-8	1990 - 1995	0C577254 - 0F348987	13549A10	H4	13220	N.S.S.	NLA	NLA(3)
500 Bulldog	540/ V-8	1995 - 2001	0F615762 - 0M050281	13549A23	H4	13220	N.S.S.	NLA	NLA(3)
800 SC	572/ V-8	1993 - 1996	0D763836 and up	3312-821030A17	H4	NLA	N.S.S.	N.S.S.	NLA(7)
800 SC	572/ V-8	1993 - 1996	0D763836 and up	3312-821030A18	H4	NLA	N.S.S.	N.S.S.	NLA(5)

- (1) Automatic choke
- (2) Black
- (3) Blue
- (4) Electric choke
- (5) Front (Blue)
- (6) In-Line
- (7) Rear (Blue)
- (8) Spacer mounted
- (9) Use if original carb is MerCarb
- (10) Use if original carb is Rochester
- (11) Use w/ in-line transmission
- (12) Use w/ V-drive transmission
- (13) V-drive
- (14) Wedge mounted
- (17) TKS Retrofit Kit

Not all parts listed are available for the European, C.I.S., Africa and Middle East Markets.
 For more information, please contact your local Mercury, Mariner, MerCruiser or Quicksilver Office.

FUEL PUMPS

FUEL PUMP



86234A05

Fuel pump mounted with filter bowl facing up
Fits MCM 120/2.5L, 140/3.0L, 470/485/488 & 160/165/200 (I/L 6 cyl.)

FUEL PUMP



8M0073435

Fuel pump mounted with filter bowl facing down
Fits 4 cyl. (2.5L, 3.0L & 3.7L) engines

FUEL PUMP

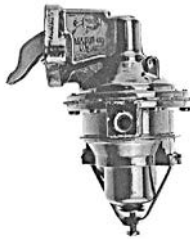

862077A 1

Fits MCM 175, 185, 205 & 4.3L/LX

FUEL PUMP



8M0058164

Fits GM V-8 (305 & 350 cid) engines

FUEL PUMP



86247T

Fits MCM/MIE 325, 330, 350 & 390

FUEL PUMP



862048A 1

Fits MCM/MIE 330, 340, 7.4L, 454 Mag, 370, 400, 420, 425 & 440

FUEL PUMP



861677T

Fits GM V-8 (454 & 502 cid) engines

FUEL PUMP



92864

Fits MCM 460, 500 Bulldog, 525SC & 575

FUEL PUMP



889275T

Fits MCM 500 EFI, 525 EFI, 575 SCI, 600 SCI, 662 SCI & 700 SCI

FUEL PUMP



861677A 2

Fits MCM 500 (Gen+)

FUEL PUMP - ELECTRIC



861155A16

low pressure lift pump
Fits MCM 100 Vazer

FUEL PUMP - ELECTRIC



8M2001321

High pressure pump
Fits MCM 100 Vazer

FUEL PUMP - ELECTRIC



861155A 6

low pressure
Fits MCM 262 Mag EFI, 4.3L/LX & 4.3LH/LXH

FUEL PUMP - ELECTRIC



861155A 3

low pressure
Fits MCM/MIE 4.3L/LH, 5.0L Gen+, 5.7L Gen+; also used as boost pump on MCM/MIE 5.0L MPI, 350 Mag MPI, MX 6.2L MPI & 496 Mag/8.1S

BOOST PUMP KIT



862264A 7

Helps minimize vapor locking
Fits MCM/MIE 4.3L, 5.0L, 5.7L & 6.2L EFI/MPI engines

FUEL PUMP/COOLER KIT



8M0125846

Fits GM V-6 & V-8 (305, 350, 377, 454 & 502 cid) EFI engines (s/n 0L000000-0M299999); also fits all 496 cid models; and Black Scorpion models (s/n 0L000000 and up)

FUEL PUMP/COOLER KIT



8M0125852

Fits GM V-6 & V-8 (305, 350 & 377 cid) MPI engines (s/n 0M300000-2A460164)

FUEL PUMP/COOLER KIT

Image not
Available.

8M0125845

Fits GM V-6 & V-8 (305, 350, 454 & 502 cid) engines w/ cool fuel (s/n 0K999999 and below)

FUEL PUMP - ELECTRIC



8M0062770

High pressure pump
Fits 75-115 EFI (2.1L) FourStroke, 150 EFI FourStroke and MCM 4.5L & 6.2L MPI (Mercury)

FUEL PUMP - ELECTRIC



8M0062771

Low pressure pump
Fits 75-115 EFI (2.1L) FourStroke, 150 EFI FourStroke and MCM 4.5L & 6.2L MPI (Mercury)

FUEL PUMP/REGULATOR KIT



866169T01

High pressure pump w/ regulator
Fits GM V-8 (305, 350, 377, 496 & 502 cid) engines w/ Gen III Cool Fuel module

FUEL PUMP - ELECTRIC



866170A01

Low pressure lift pump
Fits GM V-8 (305, 350, 377, 496 & 502 cid) engines w/ Gen III Cool Fuel module

FUEL PUMP



849930T02

Fits MCM 500 EFI & 575 SCi

FUEL PUMP - ELECTRIC



841080T01

Fits MCM 525 EFI

MERCUISER FUEL FILTERS - FUEL PUMP

FUEL PUMP FILTER



35-8M0046751

Fits MCM 120/2.5L, 140/3.0L/LX, 3.7L, 3.8L & 4.3L engines.
 Priced individually, sold @ multiples of 2
 Mercury Branded, Clamshell Package Point of Sale Packaged.

35-8M0046752

Fits MCM 120/2.5L, 140/3.0L/LX, 3.7L, 3.8L & 4.3L engines.
 Priced individually, sold @ multiples of 2
 Quicksilver Branded, Clamshell Package Point of Sale Packaged.

FUEL PUMP FILTER



35-49088T 2

Used on all MerCruiser engines with Rochester 2 barrel carburetor and Carter fuel pump.
 Priced individually, sold @ multiples of 2
 Mercury Branded, Clamshell Package Point of Sale Packaged.

35-49088Q 2

Used on all MerCruiser engines with Rochester 2 barrel carburetor and Carter fuel pump.
 Priced individually, sold @ multiples of 2
 Quicksilver Branded, Clamshell Package Point of Sale Packaged.

MERCURY® MERCURISER® COOLING SYSTEM

MERCURISER WATER PUMP REPAIR KITS - SEA WATER

BODY/ IMPELLER KIT



46- 72774A89

Fits plastic 2 pc. body sea water pump

BODY/ IMPELLER KIT



46-807151A14

Fits plastic 1 pc. body sea water pump

BODY/ IMPELLER KIT



8M0118062

Fits 2000-2016 MCM V-6 & V-8 (305, 350 & 496 cid) engines with the brass sea water pump

REAR COVER ASSEMBLY



862776A01

Plastic housing with stainless steel wear plate
Fits current small block brass seawater pump w/o air fittings

REAR COVER ASSEMBLY



863674A05

Brass housing with stainless steel wear plate
Fits current small block brass seawater pump w/ air fittings

REAR COVER ASSEMBLY



862776A02

Brass housing, no stainless steel wear plate
Fits MCM/MIE 496/8.1L brass seawater pump w/o air fittings (s/n 0M025000-0W05999)

REAR COVER ASSEMBLY



863674A04

Brass housing with stainless steel wear plate
Fits MCM/MIE 496/8.1L brass seawater pump w/ air fittings (s/n 0W060000 thru 1A380318)

MERCURY® MERCURISER®

SEA WATER PUMP IMPELLER KIT



47-59362Q08

Includes wear plates
Fits plastic 1 & 2 pc. body sea water pumps.
Quicksilver Branded, Clamshell Package Point of Sale Packaged.

SEA WATER PUMP IMPELLER KIT



47-59362A 4

Fits plastic 2 pc. body sea water pump

SEA WATER PUMP IMPELLER KIT



47-59362T 6

Fits plastic 1 pc. body sea water pump

SEA WATER PUMP IMPELLER KIT



47-8M0104229

Fits 2000 & newer MCM V-6 & V-8 engines with the brass sea water pump

HEAVY DUTY SEA WATER PUMP IMPELLER KIT



47-8M0137219

Includes shorter heavy duty impeller and overmolded inner (front) wear plate for use when the front of the seawater pump impeller housing is worn due to debris.
Fits 2000 & newer MCM V-6 & V-8 (305, 350, 496 & 502 cid) engines with the brass sea water pump excluding Mercury 4.5L & 6.2L models

HEAVY DUTY SEA WATER PUMP IMPELLER KIT



98-8M0137220

Includes shorter heavy duty impeller, rear wear plate and overmolded inner (front) wear plate for use when the front of the seawater pump impeller housing is worn due to debris.

Fits Mercury 4.5L (s/n 2A531162 and below) &
Mercury 6.2L MCM models (s/n 2A531196 and below)
Mercury 6.2L MIE models (s/n 2A530773 and below)
Mercury 6.2L TowSport models (s/n 2A531347 and below)

HEAVY DUTY SEA WATER PUMP IMPELLER KIT



98-8M0137221

Includes shorter heavy duty impeller, rear wear plate and overmolded inner (front) wear plate for use when the front of the seawater pump impeller housing is worn due to debris.

Fits Mercury 4.5L (s/n 2A531163 and above) &
Mercury 6.2L MCM models (s/n 2A531197 and above)
Mercury 6.2L MIE models (s/n 2A530774 and above)
Mercury 6.2L TowSport models (s/n 2A531348 and above)

MERCURY® MERCUISER®

MERCURISER WATER PUMP REPAIR KITS - DRIVE

WATER PUMP UPPER HOUSING REPAIR KIT



46- 96148A 8

Fits Mercury/Mariner 65 hp (4 cylinder) through V-6 outboards with short-vane impellers and fits MerCruiser I/R/MR/Alpha drives (s/n 2495186-0D469858). Quicksilver Branded

WATER PUMP UPPER REPAIR KIT

46- 96148T 8

Includes plastic pump housing assembly, impeller, face plate, gaskets, drive key or pin, water tube guide sleeve, "O" rings and geartube fill & vent screw seals. (Base not included)

Fits Mercury/Mariner 65 hp (4 cylinder) through V-6 outboards with short-vane impellers and fits MerCruiser I/R/MR/Alpha drives (s/n 2495186-0D469858). Mercury Branded, Clamshell Package Point of Sale Packaged.

46- 96148Q 8

Includes plastic pump housing assembly, impeller, face plate, gaskets, drive key or pin, water tube guide sleeve, "O" rings and geartube fill & vent screw seals. (Base not included)

Fits Mercury/Mariner 65 hp (4 cylinder) through V-6 outboards with short-vane impellers and fits MerCruiser I/R/MR/Alpha drives (s/n 2495186-0D469858). Quicksilver Branded, Clamshell Package Point of Sale Packaged.

WATER PUMP UPPER REPAIR KIT



817275K05

Fits Alpha One Gen II drives and Vazer
Mercury Branded, Clamshell Package Point of Sale Packaged.

WATER PUMP BASE KIT



46- 57234T 1

Fits MC I & R drives w/o flush screw in housing.

WATER PUMP BASE KIT

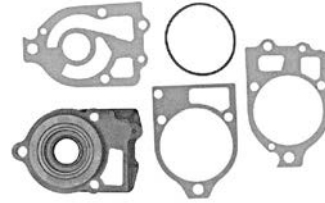

46- 44292A 3

Fits MR & Alpha One drives (1985-1990)

WATER IMPELLER REPAIR KIT



47- 89984T 5

Includes new impeller, face plate w/ face plate gaskets, drive key or pin, water tube guide sleeve, "O" rings and geartube fill & vent screw seals.

Fits Mercury/Mariner 65 hp (4 cylinder) through V-6 outboards with short-vane impellers and fits MerCruiser I/R/MR/Alpha drives (s/n 2495186-0D469858). Mercury Branded, Clamshell Package Point of Sale Packaged.

47- 89984Q 5

Fits Mercury/Mariner 65 hp (4 cylinder) through V-6 outboards with short-vane impellers and fits MerCruiser I/R/MR/Alpha drives (s/n 2495186-0D469858). Quicksilver Branded, Clamshell Package Point of Sale Packaged.

WATER IMPELLER REPAIR KIT



47- 8M0100527

Fits F40-60 FourStroke Bigfoot/Command Thrust, 60 Hp. 2-cycle BigFoot 0D000750 and above, all 75-115 FourStroke, 150 EFI FourStroke, 70-90 Hp. 2-cycle 0A996142 and above, 100-125 Hp. 2-cycle (4 cylinder) models having pump cover screws without insulators, V-200/225/250 (3.0L) 2-cycle outboards, all 4&6 cylinder Verado (with 4.80 dia. torpedo gearcases), and MerCruiser Alpha One Gen II drives (s/n 0D469859 and above).

Mercury Branded, Clamshell Package Point of Sale Packaged.

WATER IMPELLER REPAIR KIT



47-8M0100526

Fits F40-60 FourStroke Bigfoot/Command Thrust, 60 Hp, 2-cycle BigFoot 0D000750 and above, all 75-115 FourStroke, 150 EFI FourStroke, 70-90 Hp, 2-cycle 0A996142 and above, 100-125 Hp, 2-cycle (4 cylinder) models having pump cover screws without insulators, V-200/225/250 (3.0L) 2-cycle outboards, all 4&6 cylinder Verado (with 4.80 dia. torpedo gearcases), and MerCruiser Alpha One Gen II drives (s/n 0D469859 and above).
Quicksilver Branded, Clamshell Package Point of Sale Packaged.

WATER PUMP REPAIR KITS CHART

MCM Water Pump Impellers & Kits

Model	Serial # Range	Impeller Only	Impeller Repair Kit	Lower Base Kit	Upper Housing Kit
MC-I w/ plastic flush screw in lower gear housing	2495186 - 2763441	47- 89984T 4	47- 89984T 5	N.L.A.	46- 96148A 8
MC-I w/o flush screw in gear housing	2763442 - 6854392	47- 89984T 4	47- 89984T 5	46- 57234T 1(1)	46- 96148A 8
MR/Alpha One	6854393 - 0D469858	47- 89984T 4	47- 89984T 5	46- 44292A 3	46- 96148A 8
Alpha One Gen II	0D469859 and up	47- 43026T 2	47- 8M0100527	N/A	817275K05
Vazer	0W995000 and up	47- 43026T 2	47- 8M0100527	N/A	817275K05
Bravo I/III/III w/ 2 pc body sea water pump	0B664190 and up	47- 59362T 1(3)	47- 59362A 4	N/A	N/A
Bravo I/III/III w/ 1 pc body sea water pump	0B664190 and up	47- 59362T 1(3)	47- 59362T 6	N/A	N/A
Bravo I/III/III w/ brass sea water pump (excluding Mercury 4.5L & 6.2L)	0M100001 and up	47- 8M0104229(4)	47- 8M0137219	N/A	N/A
Mercury 4.5L Bravo	2A441953 - 2A531162	N/A	98- 8M0137220	N/A	N/A
Mercury 4.5L Bravo	2A531163 and up	N/A	98- 8M0137221	N/A	N/A
Mercury 6.2L Bravo	2A456613 - 2A531196	N/A	98- 8M0137220	N/A	N/A
Mercury 6.2L Bravo	2A531197 and up	N/A	98- 8M0137221	N/A	N/A
Mercury 6.2L MIE	2A456613 - 2A530773	N/A	98- 8M0137220	N/A	N/A
Mercury 6.2L MIE	2A530774 and up	N/A	98- 8M0137221	N/A	N/A
Mercury 6.2L TowSports	2A456613 - 2A531347	N/A	98- 8M0137220	N/A	N/A
Mercury 6.2L TowSports	2A531348 and up	N/A	98- 8M0137221	N/A	N/A

(1) Models which have been retrofitted with an Alpha style Gear Housing (no pre-load pin in the top of the drive shaft) must use MR/Alpha style parts.

(2) An Upper Housing Kit combined with a Lower Base Kit will yield a complete water pump assembly.

(3) Engine mounted sea water pump application, for all engines w/o the block drain feature.

(4) Engine mounted sea water pump application, for all engines with the block drain feature.

MERCURISER THERMOSTAT KITS

THERMOSTAT KIT



59078T 3

140 degree
Fits 1998 and older MCM GM in-line 4 & 6 cyl. Engines
Priced individually, sold @ multiples of 2
Mercury Branded, Clamshell Package Point of Sale Packaged.

59078Q 3

140 degree
Fits 1998 and older MCM GM in-line 4 & 6 cyl. Engines
Priced individually, sold @ multiples of 2
Quicksilver Branded, Clamshell Package Point of Sale Packaged.

THERMOSTAT KIT



807252T 5

160 degree
Fits 1987-2016 GM engines with standard cooling requiring a 160 degree thermostat.
Mercury Branded, Clamshell Package Point of Sale Packaged.

807252Q 5

160 degree
Fits 1987-2016 GM engines with standard cooling requiring a 160 degree thermostat.
Quicksilver Branded, Clamshell Package Point of Sale Packaged.

THERMOSTAT KIT



99155T 2

160 degree
Fits MCM 470/488 (s/n 6218037 and newer) & 3.7L engines

THERMOSTAT KIT



807252T 4

140 degree
Fits 1983 -2016 GM V-6 and V-8 engines with standard cooling requiring a 140-degree thermostat (except high performance engines).
Mercury Branded, Clamshell Package Point of Sale Packaged.

807252Q 4

140 degree
Fits 1983-2016 GM V-6 and V-8 engines with standard cooling requiring a 140-degree thermostat (except high performance engines).
Quicksilver Branded, Clamshell Package Point of Sale Packaged.

THERMOSTAT KIT



99155T 1

160 degree
Fits GM V-6 & V-8 engines with closed cooling (1998 and newer)

THERMOSTAT KIT



807252T 3

140 degree
Fits 1982 and older Ford and GM V-8 engines with standard cooling & 1996 and older hi-performance models. Also fits engines with closed cooling.
Mercury Branded, Clamshell Package Point of Sale Packaged.

807252Q 3

140 degree
Fits 1982 and older Ford and GM V-8 engines with standard cooling & 1996 and older hi-performance models. Also fits engines with closed cooling.
Quicksilver Branded, Clamshell Package Point of Sale Packaged.

MERCURY® MERCURISER®

HOSES - WATER

CIRCULATING PUMP HOSE



32-8M0071007

Fits MCM 120/2.5L, 140/3.0L & 160/165

CIRCULATING PUMP HOSE



32-861590A05

Fits MCM/MIE GM V-6 and V-8 (305, 350 & 377 cid) engines

CIRCULATING PUMP HOSE



32-33189

Fits MCM/MIE GM V-8 283, 305, 327 & 350 cid engines

CIRCULATING PUMP HOSE



32-54570

Fits MCM/MIE Ford V-8 302 & 351 cid engines

CIRCULATING PUMP HOSE



32-89718 1

Fits MCM/MIE GM V-8 (427, 454 & 502 cid) engines

CIRCULATING PUMP HOSE



32-89718 3

Fits MCM 7.4L Bravo III (Gen V) & 454 Mag Bravo (Gen V & VI)

CIRCULATING PUMP HOSE



32-861183

Fits MCM/MIE 7.4L MPI (L29)

CIRCULATING PUMP HOSE



32-842416A 1

Fits MCM 500 EFI

CIRCULATING PUMP HOSE



32-847677A01

Fits MCM 500 Bulldog & 525 SC (Gen V & VI)

32-847677A01

Fits MCM 500 Bulldog & 525 SC (Gen V & VI)

CIRCULATING PUMP HOSE



32-842412A02

Fits MCM 575 SCi, 600 SC (Gen V & VI) & 800 SC (Gen V)

HOSE - MOLDED



32-807661

Transom to oil cooler
1-1/4 in. (32 mm) I.D. at one end; 3/4 in. (19 mm) I.D. at other end of hose
Fits MCM 3.0L, GM V-6 & V-8 (305 & 350 cid) engines

HOSE - MOLDED



32-815413

Transom to oil cooler
1 in. (25 mm) I.D. at one end; 3/4 in. (19 mm) I.D. at other end of hose
Fits 3.0L/LX

HOSE - MOLDED



32-806433

Cooler to thermostat housing
1 in. (25 mm) I.D. at one end; 3/4 in. (19 mm) I.D. at other end of hose
Fits 3.0L/LX

HOSE - MOLDED



32-815412

Cooler to thermostat housing
1 in. (25 mm) I.D. at one end; 3/4 in. (19 mm) I.D. at other end of hose
Fits 3.0L/LX

HOSE - MOLDED



32-47639

Thermostat housing to exhaust manifold
1 in. (25 mm) I.D.
Fits GM in-line 4 & 6 cyl.

HOSE - MOLDED



32-52481

Thermostat housing to exhaust manifold
1 in. (25 mm) I.D.
Fits GM in-line 4 & 6 cyl.

HOSE - MOLDED



32-806993

Thermostat housing exhaust manifold
1 in. (25 mm) I.D.
Fits 3.0L/LX

HOSE - MOLDED



32-861634

Thermostat housing to exhaust manifold
1 in. (25 mm) I.D.
Fits 3.0L

HOSE - MOLDED



32-89653

Cylinder head to exhaust manifold
1-1/4 in. (32 mm) I.D.
Fits 3.7L

HOSE - MOLDED



32-76327

Engine circulating pump to intake manifold
1-1/2 in. (38 mm) I.D. at one end; 1-1/4 in. (32 mm) I.D. at other end of hose
Fits 3.7L models

HOSE - MOLDED



32-77245

Thermostat housing to heat exchanger
1-1/4 in. (32 mm) I.D.
Fits 3.7L models

HOSE - MOLDED



32-98033A 3

Transom to thermostat housing
1-1/4 in. (32 mm) I.D. at ends of hose
Fits GM V-6 and V-8 (305 & 350 cid) engines

HOSE - MOLDED

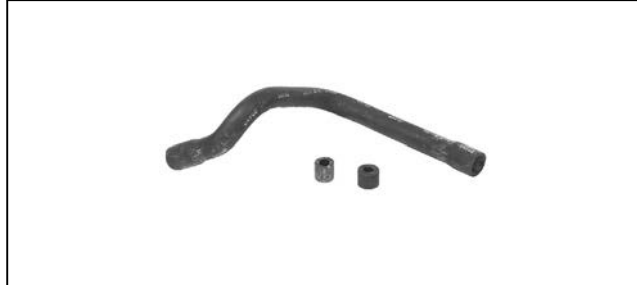

32-41642A 3

Transom to oil cooler
1-1/4 in. (32 mm) I.D. at ends of hose
Fits MCM V-6 engines

HOSE - MOLDED



32-88795

Seawater pump to oil cooler
1-1/4 in. (32 mm) I.D.
Fits MCM 4.3L/LX Bravo
Fits MIE GM V-8 (305 & 350 cid) engines

HOSE - MOLDED



32-860205

Seawater pump to oil cooler
1-1/4 in. (32 mm) I.D.
Fits MCM V-6 engines

HOSE - MOLDED



32-806209 1

Cooler to thermostat housing
1-1/4 in. (32 mm) I.D. at ends of hose
Fits MCM V-6

HOSE - MOLDED



32-860206

Oil cooler to oil cooler
1-1/4 in. (32 mm) I.D.
Fits 262 Mag EFI & 4.3L EFI

HOSE - MOLDED



32-806856

Cooler to thermostat housing
1-1/4 in. (32 mm) I.D.
Fits 4.3L/LX, 5.0L/LX, 5.7L/LX & 350 Mag

HOSE - MOLDED



32-16012

Cooler to thermostat housing
1-1/4 in. (32 mm) I.D.
Fits 4.3L/LX, 230/5.0L MIE and 260/5.7L MIE

HOSE - MOLDED



32-808033

Cooler to thermostat housing
1-1/4 in. (32 mm) I.D.
Fits MCM/MIE V-6 & V-8 (305, 350 & 377 cid) engines

HOSE - MOLDED



32-88794

Cooler to thermostat housing
1-1/4 in. (32 mm) I.D.
Fits MCM/MIE V-6 and V-8 (305 & 350 cid)

HOSE - MOLDED



32-18810

Thermostat housing to starboard exhaust manifold
1 in. (25 mm) I.D. at ends of hose
Fits MCM GM V-6

MERCURY® MERCURISER®

HOSE - MOLDED



32-41940

Thermostat housing to starboard exhaust manifold
1-3/8 in. (35 mm) I.D. at ends of hose
Fits 185 & 205

HOSE - MOLDED



32-87117 1

Thermostat housing to starboard exhaust manifold
1 in. (25 mm) I.D. at one end; 13/16 in. (21 mm) I.D. at other end of hose
Fits 4.3L/LX and MCM/MIE V-8 (305 & 350 cid) engines

HOSE - MOLDED



32-806636 1

Thermostat housing to starboard exhaust manifold
1 in. (25 mm) I.D. at ends of hose
Fits MCM/MIE GM V-6 & V-8 (305 & 350 cid) engines

HOSE - MOLDED



32-807697

Thermostat housing to starboard exhaust manifold
1 in. (25 mm) I.D. at ends of hose
Fits MCM/MIE GM V-6 & V-8 (305, 350 & 377 cid) engines

HOSE - MOLDED



32-862124

Thermostat housing to starboard exhaust manifold
1 in. (25 mm) I.D. at ends of hose
Fits 4.3L/LH

HOSE - MOLDED



32-16021 1

Thermostat housing to port exhaust manifold
1 in. (25 mm) I.D. at ends of hose
Fits MCM/MIE V-6 and V-8 (305 & 350 cid) engines

HOSE - MOLDED



32-806635 1

Thermostat housing to port exhaust manifold
1 in. (25 mm) I.D. at ends of hose
Fits MCM/MIE GM V-6 & V-8 (305 & 350 cid) engines

HOSE - MOLDED



32-860144

Thermostat housing to port exhaust manifold
1 in. (25 mm) I.D. at ends of hose
Fits MCM V-6 & V-8 (305, 350 & 377 cid) engines

HOSE - MOLDED

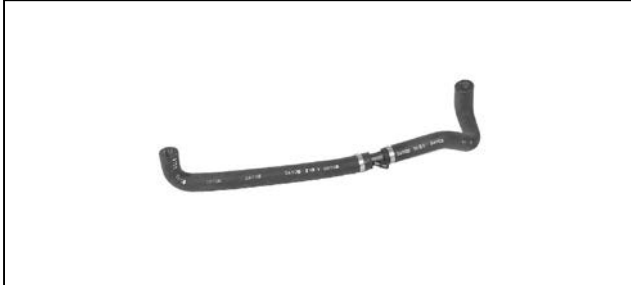

32-862139

Thermostat housing to port exhaust manifold
1 in. (25 mm) I.D. at ends of hose
Fits 4.3L/LH

HOSE - MOLDED



32-60198

Thermostat housing to starboard exhaust elbow
1 in. (25 mm) I.D. at ends of hose
Fits Ford V-8 302 cid

HOSE - MOLDED



32-60203

Thermostat housing to front of exhaust manifold
1 in. (25 mm) I.D.
Fits Ford V-8 (302 & 351cid) engines

HOSE - MOLDED



32-60199

Thermostat housing to port exhaust elbow
1 in. (25 mm) I.D. at ends of hose
Fits Ford V-8 302 cid

HOSE - MOLDED

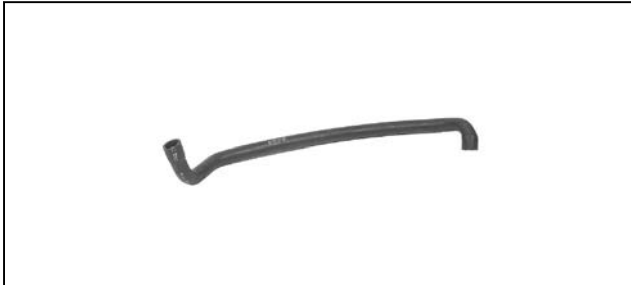

32-60200

Thermostat housing to rear of starboard exhaust manifold
1 in. (25 mm) I.D. at ends of hose
Fits Ford V-8 302 cid

HOSE - MOLDED



32-96246A 4

Transom to oil cooler
1-1/4 in. (32 mm) I.D. at ends of hose
Fits MCM GM V-8 (305, 350 & 454 cid) engines

HOSE - MOLDED



32-60201

Thermostat housing to rear of port exhaust manifold
1 in. (25 mm) I.D. at ends of hose
Fits Ford V-8 302 cid

HOSE - MOLDED



32-88795 2

Seawater pump to oil cooler
1-1/4 in. (32 mm) I.D.
Fits MCM 5.0L/LX Bravo
Fits MCM/MIE GM V-8 350 cid engines

MERCURY® MERCURISER®

HOSE - MOLDED



32-808044 1

Seawater pump to oil cooler
1-1/4 in. (32 mm) I.D.
Fits MCM/MIE GM V-8 (305, 350 & 377 cid) engines

HOSE - MOLDED



32-808032

Oil cooler to oil cooler
1-1/4 in. (32 mm) I.D.
Fits 5.7L, 350 Mag & 377 Scorpion Tow Sports engines

HOSE - MOLDED



32-808045

Oil cooler to oil cooler
1-1/4 in. (32 mm) I.D.
Fits MIE V-8 350 cid and MCM/MIE V-8 (454 & 502 cid) engines

HOSE - MOLDED



32-860089 1

Oil cooler to oil cooler
1-1/4 in. (32 mm) I.D.
Fits 5.0L, 5.7L/LX, 350 Mag & MX 6.2L MPI

HOSE - MOLDED



32-16011

Cooler to thermostat housing
1-1/4 in. (32 mm) I.D.
Fits MCM V-8 (305, 350 & 454 cid) engines

HOSE - MOLDED



32-71613

Cooler to thermostat housing
1-1/4 in. (32 mm) I.D.
Fits MCM/MIE GM V-8 (305 & 350 cid) engines

HOSE - MOLDED



32-861512

Cooler to thermostat housing
1-1/4 in. (32 mm) I.D. at ends of hose
Fits 5.0L Alpha (Gen+)

HOSE - MOLDED



32-844882 1

Cooler to thermostat housing
1-1/4 in. (32 mm) I.D.
Fits 377 Scorpion Sterndrive & 500 EFI

HOSE - MOLDED



32-48132

Thermostat housing to front of exhaust manifolds
1 in. (25 mm) I.D.

Fits MCM/MIE V-8 (305, 327, 350, 427 & 454 cid) engines

HOSE - MOLDED



32-73794

Thermostat housing to rear of starboard exhaust manifold
1 in. (25 mm) I.D. at ends of hose

Fits MCM/MIE GM V-8 (305 & 350 cid) engines

HOSE - MOLDED



32-73795

Thermostat housing to rear of port exhaust manifold
1 in. (25 mm) I.D. at ends of hose

Fits MCM/MIE GM V-8 (305 & 350 cid) engines

HOSE - MOLDED



32-73796

Thermostat housing to exhaust manifolds
1 in. (25 mm) I.D. at ends of hose

Fits MCM/MIE GM V-8 (305 & 350 cid) engines

HOSE - MOLDED



32-841452

Thermostat housing to port exhaust elbow
1 in. (25 mm) I.D.

Fits 377 Scorpion (Sterndrive)

HOSE - MOLDED



32-19403

Heat exchanger to exhaust manifold
1 in. (25 mm) I.D. at ends of hose

Fits 5.7L & 7.4 MIE

HOSE - MOLDED



32-92837

Heat exchanger to oil cooler
1-1/4 in. (32 mm) I.D.

Fits 5.0L, 5.7L & 7.4L

HOSE - MOLDED



32-897145

Connector to seawater pump
1-1/4 in. (32 mm) I.D.

Fits 7.4L & 8.2L MIE

HOSE - MOLDED



32- 18159 1

Seawater pump to oil cooler
1-1/4 in. (32 mm) I.D.
Fits 7.4L Bravo

HOSE - MOLDED



32- 18320

Seawater pump to oil cooler
1-1/4 in. (32 mm) I.D.
Fits 454 Mag Bravo

HOSE - MOLDED



32- 805251

Seawater pump to oil cooler
1-1/4 in. (32 mm) I.D.
Fits MCM 502 Mag

HOSE - MOLDED



32- 807404

Seawater pump to oil cooler
1-1/4 in. (32 mm) I.D.
Fits MCM/MIE V-8 (454 & 502 cid) engines

HOSE - MOLDED



32- 808044

Seawater pump to oil cooler
1-1/4 in. (32 mm) I.D.
Fits MCM/MIE GM V-8 (454 & 502 cid) engines

HOSE - MOLDED



32- 816197

Seawater pump to oil cooler
1-1/4 in. (32 mm) I.D.
Fits 465 & 500 Bulldog

HOSE - MOLDED



32- 818741

Seawater pump to oil cooler
1-1/4 in. (32 mm) I.D.
Fits 7.4L Bravo

HOSE - MOLDED



32- 821417

Seawater pump to oil cooler
1-1/4 in. (32 mm) I.D.
Fits 7.4L & 8.2L MIE

HOSE - MOLDED



32-821418

Seawater pump to oil cooler
1-1/4 in. (32 mm) I.D.
Fits 454 Mag

HOSE - MOLDED



32-848178

Seawater pump to oil cooler
1-1/4 in. (32 mm) I.D.
Fits 450, 500, 525 & 600 SC

HOSE - MOLDED



32-849604

Seawater pump to oil cooler
1-1/4 in. (32 mm) I.D.
Fits 500

HOSE - MOLDED



32-849935

Seawater pump to fuel cooler
1-1/4 in. (32 mm) I.D.
Fits 500 EFI & 575 SCi

HOSE - MOLDED



32-856706

Seawater pump to oil cooler
1-1/4 in. (32 mm) I.D.
Fits 454 Mag

HOSE - MOLDED

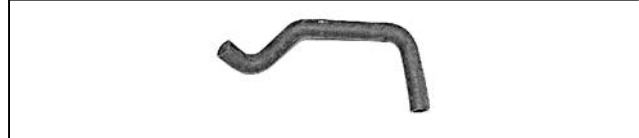

32-12817

Oil cooler to oil cooler
1-1/4 in. (32 mm) I.D.
Fits 370, 420, 425, 500 & 575

HOSE - MOLDED



32-63829

Oil cooler to oil cooler
1-1/4 in. (32 mm) I.D.
Fits 330/340/7.4L MIE

HOSE - MOLDED



32-807405

Oil cooler to oil cooler
1-1/4 in. (32 mm) I.D.
Fits 7.4L/8.2L MPI MIE, 454 Mag & 502 Mag

MERCURY® MERCRUISER®

HOSE - MOLDED



32-807406

Oil cooler to oil cooler, 1-1/4 in. (32 mm) I.D.
Use with 13 in. long engine oil cooler
Fits 7.4L & 8.2L MPI MIE, 454 Mag & 502 Mag with VST fuel system

HOSE - MOLDED



32-807406 1

Fuel cooler to oil cooler, 1-1/4 in. (32 mm) I.D.
Use with 13 in. long engine oil cooler
Fits 7.4L & 8.2L MPI MIE, 454 Mag & 502 Mag with fuel cooled system

HOSE - MOLDED



32-807989

NLA - Order 32-71613
Fuel cooler to oil cooler, 1-1/4 in. (32 mm) I.D.
Use with 10 in. long oil cooler
Fits 7.4L & 8.2L MPI MIE, 454 Mag & 502 Mag

HOSE - MOLDED



32-814749

Oil cooler to oil cooler
1-1/4 in. (32 mm) I.D.
Fits 7.4L MIE

HOSE - MOLDED



32-816504

Oil cooler to oil cooler
1-1/4 in. (32 mm) I.D.
Fits 525SC, 600SC & 800SC

HOSE - MOLDED

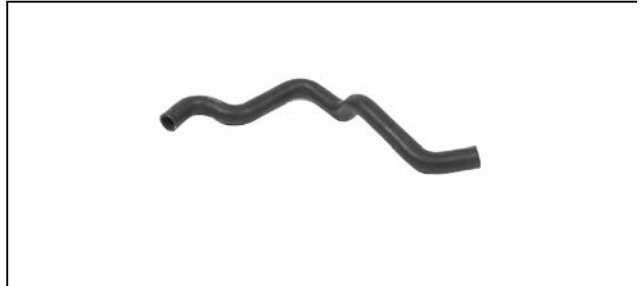

32-844881

Fuel cooler to oil cooler
1-1/4 in. (32 mm) I.D.
Fits 500 EFI & 575 SCi

HOSE - MOLDED

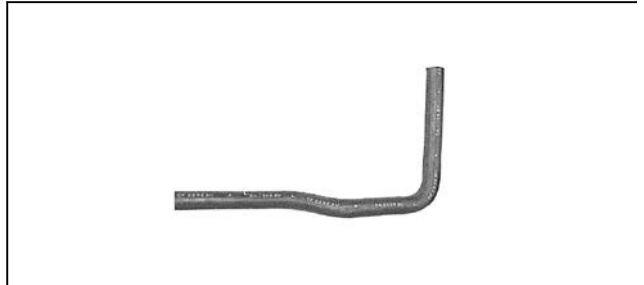

32-848956

Oil cooler to oil cooler
1-1/4 in. (32 mm) I.D.
Fits 450, 465, 500, 525 SC, 575 SCi & 600 SC

HOSE - MOLDED



32-897142

Cooler to thermostat housing
1-1/4 in. (32 mm) I.D.
Fits 7.4L

HOSE - MOLDED



32-896999

Cooler to thermostat housing
1-1/4 in. (32 mm) I.D.
Fits 7.4L

HOSE - MOLDED



32-807407 3

Cooler to thermostat housing
1-1/4 in. (32 mm) I.D.
Fits 7.4L MPI MCM/MIE & 8.2L MPI MIE

HOSE - MOLDED



32-896998

Cooler to thermostat housing
1-1/4 in. (32 mm) I.D.
Fits MCM/MIE GM V-8 (427, 454 & 502 cid) engines

HOSE - MOLDED



32-844475

Cooler to thermostat housing
1-1/4 in. (32 mm) I.D.
Fits 575 SCi

HOSE - MOLDED



32-805469

Cooler to thermostat housing
1-1/4 in. (32 mm) I.D.
Fits 502 EFI (Gen V)

HOSE - MOLDED



32-844882 1

Cooler to thermostat housing
1-1/4 in. (32 mm) I.D.
Fits 377 Scorpion Sterndrive & 500 EFI

HOSE - MOLDED



32-807407

Cooler to thermostat housing
1-1/4 in. (32 mm) I.D.
Fits 7.4L & 8.2L MIE and 454 & 502 Mag

HOSE - MOLDED



32-89730 1

Thermostat housing to starboard exhaust manifold
1 in. (25 mm) I.D. at one end; 13/16 in. (21 mm) I.D. at other end of hose
Fits MCM/MIE V-8 (454 & 502 cid) engines

MERCURY® MERCRUISER®

HOSE - MOLDED



32-807201

Thermostat housing to starboard exhaust manifold
1 in. (25 mm) I.D. at ends of hose
Fits 7.4L & 8.2L MIE and 454 & 502 Mag

HOSE - MOLDED



32-861318

Thermostat housing to starboard exhaust manifold
1 in. (25 mm) I.D. at ends of hose
Fits 7.4L & 8.2L MIE and 454 & 502 Mag

HOSE - MOLDED



32-848954

Thermostat housing to starboard exhaust manifold
1 in. (25 mm) I.D. at ends of hose
Fits 500 & 500 Bulldog

HOSE - MOLDED



32-89749 1

Thermostat housing to port exhaust manifold
1 in. (25 mm) I.D. at one end; 13/16 in. (21 mm) I.D. at other end of hose
Fits MCM/MIE GM V-8 (454 & 502 cid) engines

HOSE - MOLDED



32-849939

Thermostat housing to starboard exhaust manifold
1 in. (25 mm) I.D.
Fits 500 EFI

HOSE - MOLDED



32-97385 2

Thermostat housing to port exhaust manifold
1 in. (25 mm) I.D. at ends of hose
Fits 340/7.4L & 8.2L MIE

HOSE - MOLDED



32-849943

Thermostat housing to starboard exhaust manifold
1 in. (25 mm) I.D.
Fits 575 SCi

HOSE - MOLDED



32-97385 3

Thermostat housing to port exhaust manifold
1 in. (25 mm) I.D. at ends of hose
Fits 7.4L & 8.2L MIE

MERCURY® MERCRUISER® COOLING SYSTEM

HOSE - MOLDED



32-816347

Thermostat housing to port exhaust manifold
1 in. (25 mm) I.D. at ends of hose
Fits 525SC

HOSE - MOLDED



32-849941

Thermostat housing to starboard exhaust elbow
1 in. (25 mm) I.D.
Fits 575 SCi

HOSE - MOLDED



32-848955

Thermostat housing to port exhaust manifold
1 in. (25 mm) I.D. at ends of hose
Fits 500 & 500 Bulldog

HOSE - MOLDED



32-849936

Thermostat housing to port exhaust elbow
1 in. (25 mm) I.D.
Fits 500 EFI

HOSE - MOLDED



32-849938

Thermostat housing to port exhaust manifold
1 in. (25 mm) I.D.
Fits 500 EFI

HOSE - MOLDED



32-849940

Thermostat housing to port exhaust elbow
1 in. (25 mm) I.D.
Fits 575 SCi

HOSE - MOLDED



32-849937

Thermostat housing to starboard exhaust elbow
1 in. (25 mm) I.D.
Fits 500 EFI

HOSE



32-13556A 1

Transom to seawater pump
1-1/4 in. (32 mm) I.D. x 10 ft. (3.05 m) length
Fits 377 Scorpion (Sterndrive)

MERCURY® MERCRUISER®

HOSE



32-8M0062666

Transom to seawater pump (Red color)
1-1/4 in. (32 mm) I.D. x 8 ft. (2.44 m) length
Fits MCM/MIE GM V-6 and V-8 (305, 350, 377, 454, 502, 540 & 572 cid) engines

HOSE



32-8M0062614

1 in. (25 mm) I.D. x 48 in. (1219 mm) length
Thermostat housing to exhaust manifolds and elbows

HOSE



32-47642

Transom to thermostat housing
5/8 in. (16 mm) I.D. x 49 in. (1244 mm) length
Fits 120, 140, 160, 165 (6 cyl.) & 888

HOSE



32-8M0062634

Transom to thermostat housing
3/4 in. (19 mm) I.D. x 44 in. (1118 mm) length
Fits MCM 120/2.5L and 140/3.0L/LX

HOSE



32-8M0062665

Seawater pump to oil cooler (Red color)
1-1/4 in. (32 mm) I.D. x 48 in. (1219 mm) length
Fits MIE Ford V-8 (302 & 351 cid) engines
Fits MCM/MIE GM V-8 (327, 350, 454 & 572 cid) engines

HOSE



32-866331

Seawater pump to oil cooler
1-1/4 in. (32 mm) I.D. x 8 in. (203 mm) length
Fits MIE Tow Sports 350 cid engines

HOSE - BELL HOUSING



32-32461

5/8 in. (16 mm) I.D. x 13-3/4 in. (349 mm) length
Fits MC-I, R, MR & Alpha One

HOSE - BELL HOUSING



32-8M0109048

3/4 in. (19 mm) I.D. formed hose
Fits MR, Alpha One & Gen II

MERCURY® MERCURISER® COOLING SYSTEM

HOSE - BELL HOUSING



32-43437

NLA - Order 32-8M0090859
Fits Bravo transom

HOSE - BELL HOUSING



32-8M0090859

Hose kit replaces 32-43437
Fits Bravo transom

OIL COOLERS

OIL COOLER



47610A15

Engine and/or Transmission,
Flywheel housing mounted cooler
Fits MCM Hi-Perf GM V-8 engines.

OIL COOLER



63831A 3

Engine
7.88 in. (200 mm) overall length, 1.25 in. (32 mm) O.D. hose fittings
Fits MCM/MIE GM V-8 427/454 cid engines.

OIL COOLER



63832A 1

Transmission and/or power steering
11.88 in. (302 mm) overall length, 1.25 in. (32 mm) O.D. hose fittings
Fits MCM/MIE Ford & GM V-8 engines.

OIL COOLER



63832T

Transmission
14.88 in. (378 mm) overall length, 1.25 in. (32 mm) O.D. hose fittings
Fits MCM/MIE Ford & GM V-8 engines.

OIL COOLER



85152T

Engine and Power Steering
16.63 in. (422 mm) overall length, 1.25 in. (32 mm) O.D. hose fittings
Fits MCM GM V-8 454 cid engines.

OIL COOLER



89690T

Engine and Power Steering
11.63 in. (295 mm) overall length, 1.25 in. (32 mm) O.D. hose fittings
Fits MCM GM V-8 350 & 454 cid engines.

OIL COOLER



99356A 1

Power Steering
7.87 in. (200 mm) overall length, 1.00 in. (25 mm) O.D. hose fittings
Fits MCM in-line 4 cyl. engines.

OIL COOLER



99356A 2

Power Steering
7.87 in. (200 mm) overall length, 1.25 in. (32 mm) O.D. hose fittings
Fits MCM GM V-6 & V-8 engines

OIL COOLER



805561T

Engine and Power Steering
19.62 in. (498 mm) overall length, 1.25 in. (32 mm) O.D. hose fittings,
P/S hose connectors offset from water hose connectors
Fits MCM 502 EFI (Gen V) (s/n 0D840650-0F114528)

OIL COOLER



805561T 1

Engine and Power Steering
19.62 in. (498 mm) overall length, 1.25 in. (32 mm) O.D. hose fittings,
P/S hose connectors directly in-line with water hose connectors
Fits MCM 502 EFI (Gen V) (s/n 0F114529-0F802599)

OIL COOLER



806426T

Engine
7.88 in. (200 mm) overall length, 1.25 in. (32 mm) O.D. hose fittings
Fits MIE 7.4L (Gen V & VI) (s/n 0F160000-0K999999) and MCM 4.5L MPI (s/n 2A441953-2A530777)

OIL COOLER



806428T

Engine and Power Steering
11.63 in. (295 mm) overall length, 1.25 in. (32 mm) O.D. hose fittings
Fits MCM 7.4L Bravo (Gen V) (s/n 0F114760-0F800699).

OIL COOLER



807371T

Engine,
9.75 in. (248 mm) overall length, 1.25 in. (32 mm) O.D. hose fittings and in-line oil
hose connections
Fits MCM/MIE GM V-8 454/502 cid engines (Gen VI).

OIL COOLER



807371T 1

Engine,
10 in. (254 mm) overall length, 1.25 in. (32 mm) O.D. hose fittings and off-set oil
hose connections
Fits MCM/MIE GM V-8 454/502 cid engines (Gen VI).

MERCURY® MERCURISER® COOLING SYSTEM

OIL COOLER



807372T

Engine,
13.50 in. (343 mm) overall length, 1.25 in. (32 mm) O.D. hose fittings
Fits MCM/MIE GM V-8 454/502 cid engines (Gen VI).

OIL COOLER



808029T

Transmission
8.75 in. (222 mm) overall length, 1.25 in. (32 mm) O.D. hose fittings
Fits MIE GM V-8 350/377 cid Tow Sports engines

OIL COOLER



849291

Power Steering
10.30 in. (262 mm) overall length, 1.25 in. (32 mm) O.D. hose fittings
Fits MCM Hi-Perf V-8 502/540/572 cid engines.

OIL COOLER



849952A03

Engine
19.50 in. (495 mm) overall length, 1.25 in. (32 mm) O.D. hose fittings
Fits MCM Hi-Perf 500 EFI, 525 EFI and 575 SCi

OIL COOLER



8M0125855

Power Steering
11.50 in. (292 mm) overall length, 1.25 in. (32 mm) O.D. hose fittings
Fits MCM GM in-line 4 cyl., V-6 & V-8 engines.

OIL COOLER



862837T

Transmission
16.62 in. (422 mm) overall length, 1.25 in. (32 mm) O.D. hose fittings
Fits MIE GM V-8 350 & 454/502 cid engines.

OIL COOLER



863820T 1

Power Steering
11.50 in. (292 mm) overall length, 1.25 in. (32 mm) O.D. hose fittings
Fits MCM 4.3L, 5.0L, 5.7L & 6.2L MPI engines(s/n 0M300000-2A528897)

OIL COOLER



863832T01

Transmission
17 in. (431 mm) overall length, 1.25 in. (32 mm) O.D. hose fittings
Fits MIE & Tow Sports 350 Mag MPI & MX 6.2L MPI (s/n 0M300000 and up)

MERCURY® MERCURISER®

OIL COOLER



863842T02

Transmission
9.74 in. (247 mm) overall length, 1.25 in. (32 mm) O.D. hose fittings
Fits MIE & Tow Sports 350 Mag MPI & MX 6.2L MPI (s/n 0M313035-2A455246)

OIL COOLER



863904T

Engine
8.97 in. (228 mm) overall length, 1.25 in. (32 mm) O.D. hose fittings and one 3/4 in. (19 mm) hose fitting.
Fits MCM 496 Mag & HO (s/n 0M095325-1A352731) and MIE 8.1S & HO (s/n 0M027851-1A380318)

OIL COOLER



879194T52

Power Steering - Axis
13 in. (330 mm) overall length, 1.25 in. (32 mm) O.D. hose fittings

Fits MCM V-8 MPI engines with Axis steering

OIL COOLER



879194T60

Transmission
13 in. (330 mm) overall length, 1.25 in. (32 mm) O.D. hose fittings
Fits Tow Sports 350 Mag MPI & MX 6.2L MPI (s/n 0M391600-2A455371) with B/W 45C transmission

OIL COOLER



879288T46

Engine
9 in. (229 mm) overall length, 1.25 in. (32 mm) O.D. hose fittings. fitting.
Fits MCM 496 Mag & HO EC and MIE 8.1S & HO EC

OIL COOLER



8M0045696

Engine
13.50 in. (343 mm) overall length, 1.25 in. (32 mm) O.D. hose fittings.
Fits MCM 8.2L Mag & HO and MIE 8.2L & HO EC (s/n 1A350340-2A041664)

OIL COOLER



8M0125858

Power Steering
11.50 in. (292 mm) overall length, 1.25 in. (32 mm) O.D. hose fittings
Fits MCM 4.5L and 6.2L MPI Mercury built mechanical shift engines

MERCURY® MERCRUISER® EXHAUST SYSTEM

MERCURY® MERCRUISER® EXHAUST SYSTEM

EXHAUST WATER SHUTTERS

WATER SHUTTER

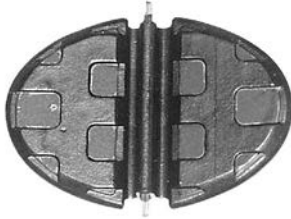

60930

Fits various MCM applications

WATER SHUTTER



807166A 1

2.48 in. diameter at cross pin

WATER SHUTTER



807166A 2

2.98 in. diameter at cross pin

WATER SHUTTER



807166A 3

2.50 in. diameter at cross pin

This kit is designed to replace both of the offset plate water shutters p/n 14348A1.

WATER SHUTTER



99370A 2

Fits older MCM applications

MERCURY® MERCRUISER®

MERCURY® MERCUISER® EXTERNAL ENGINE

V-BELTS

V-BELT



- 57- 57298Q**
28 in. (711 mm) length
- 57- 13457Q**
29 in. (737 mm) length
- 57- 94290Q**
32-3/8 in. (822 mm) length
- 57- 74271Q**
35-1/8 in. (892 mm) length
- 57- 65607Q**
37 in. (940 mm) length
- 57- 862054Q**
39-1/2 in. (1003 mm) length
- 57- 69143Q**
40 in. (1016 mm) length
- 57- 64032Q 1**
41 in. (1041 mm) length
- 57- 93658Q**
44 in. (1118 mm) length
- 57- 44207Q**
44-5/8 in. (1133 mm) length
- 57- 48120Q 1**
46 in. (1168 mm) length
- 57- 78200Q 1**
47 in. (1194 mm) length
- 57- 48122Q**
48 in. (1219 mm) length
- 57- 816034Q**
48-1/8 in. (1222 mm) length
- 57- 96834Q**
50 in. (1270 mm) length
- 57- 821023Q**
51-5/8 in. (1313 mm) length
- 57- 37619Q**
52 in. (1321 mm) length
- 57- 816295Q**
52-1/2 in. (1333 mm) length
- 57- 13458Q**
55 in. (1397 mm) length
- 57- 812427Q**
56 in. (1422 mm) length

SERPENTINE BELTS

SERPENTINE BELT

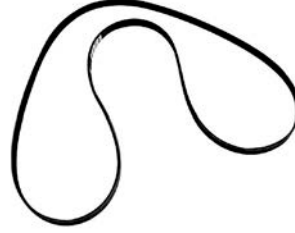

- 57- 8M0087881**
1409 mm Length
Fits MCM 4.5L Alpha engines with standard cooling
- 57- 8M0088876**
1687 mm length
Fits MCM 4.5L Alpha & Bravo and 6.2L MPI (s/n 2A456613 and up) engines with closed cooling
- 57- 8M0097728**
1713 mm length
Fits MCM 4.5L Bravo and 6.2L MPI (s/n 2A456613 and up) engines with standard cooling
- 57- 865615Q09**
1780 mm length
Fits 1999-2001 MCM V-6 & V-8 (305 & 350 cid) Alpha engines with high mounted alternator (s/n 0L619000-0M320024)
- 57- 807755Q05**
1930 mm length
- 57- 865615Q04**
1941 mm length
Fits 2001 and newer MCM V-6 & V-8 (305 & 350 cid) Alpha engines with standard cooling (s/n 0M320025 and above)
- 57- 8M2018590**
2086 mm
Fits 2011 MCM 4.3L MPI EC Alpha engines with standard cooling
- 57- 865635Q02**
2111 mm length
Fits 2005 and newer MIE 8.1S engines (s/n 0W390000 and up). Also fits 2005 & newer MCM 496 Mag engines (s/n 0W310000 and up) that the power steering pump has been removed.
- 57- 865615Q10**
2195 mm length
Fits 2001 and newer MIE engines with closed cooling and the 4-1/4 in. idler pulley
- 57- 861758Q**
2197 mm length
- 57- 865615Q05**
2233 mm length
Fits 2001 and newer MIE & Tow Sports engines with standard cooling and the 4-1/4 in. idler pulley
- 57- 807755Q04**
2240 mm length
- 57- 865615Q12**
2266 mm length
- 57- 865615Q02**
2285 mm length
Fits 2001-2004 MIE 8.1S engines (s/n 0M025000-0W389999). Also fits 2001-2005 MCM 496 Mag engines (s/n 0M025000-0W309999) that the power steering pump has been removed.
- 57- 8M0045986**
2287 mm
Fits 2010 & newer MIE 8.2L & HO EC engines

57-861759Q

2352 mm length

57-865615Q07

2467 mm length

Fits 1998-2001 MCM V-8 (454 & 502 cid) Bravo engines with serpentine belt that the power steering pump is being removed.

57-861757Q

2471 mm length

57-865635Q01

2519 mm length

Fits MCM 496 Mag (s/n 0W310000 and up)

57-865615Q08

2535 mm length

Fits 1999-2002 MCM V-6 & V-8 (305, 350 & 377 cid) Bravo engines with high mounted alternator that the power steering pump is being removed (s/n 0L619000-0M343007).

57-865615Q11

2638 mm length

57-861049Q

2649 mm length

57-865615Q06

2667 mm length

57-865615Q03

2704 mm length

Fits 2001-2016 MCM V-6 & V-8 (305 & 350 cid) Alpha engines with closed cooling and Bravo engines with standard cooling (s/n 0M320025 thru 2A455872)

57-879288Q20

2732 mm

Fits MCM 496 Mag & HO with Axius steering (s/n 1A349534 & below), also MCM 4.3L MPI EC engine with closed cooling

57-8M2018984

2782 mm

Fits 2011 MCM 4.3L MPI EC Bravo engines with standard cooling; also fits 2008 & newer MCM V-8 (305, 350 & 377 cid) engines w/ Axius steering

57-865615Q01

2830 mm length

Fits MCM 496 Mag (s/n 0M025000-0W309999)

57-879288Q21

2910 mm

Fits MCM 496 Mag & HO with Axius steering (s/n 1A349535 and up)

57-8M0045227

3157 mm

Fits 2010 & newer MCM 8.2L Mag & HO EC engines

SERPENTINE BELT KIT

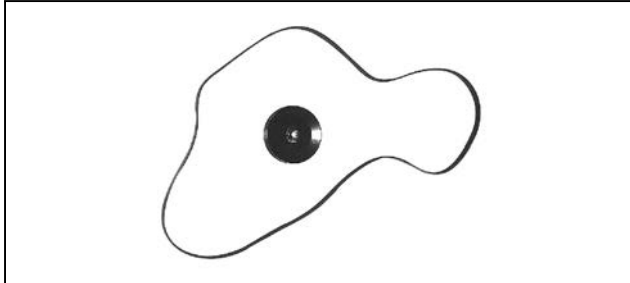

57-861758A 1

2197 mm length belt & pulley

57-861759A 1

2352 mm length belt & pulley

57-861757A 1

2471 mm length belt & pulley

57-861049A 2

2649 mm length belt & pulley

57-861049A 1

2667 mm length belt & pulley

ENGINE COUPLERS

ENGINE COUPLER



76850A 2

Crankshaft stud mount

Fits MCM GM in-line engines, V-6 and V-8 (283, 305 & 350 cid) engines

ENGINE COUPLER



12632A 7

Triangular shape, flywheel mount

Fits MCM 120/2.5L & 140/3.0L (1987-1993)

ENGINE COUPLER



12632A 6

Triangular shape, flywheel mount

Fits MCM 3.0L/LX (1994-1998)

ENGINE COUPLER



69354A 2

Crankshaft stud mount

Fits MCM 470 & 485

ENGINE COUPLER



97432A 2

Flywheel mount
Fits MCM 3.7L engines (1983-1989)

ENGINE COUPLER



18643A 5

Triangular shape, flywheel mount
Fits MCM 3.0L (1999-2016), 4.5L MPI, GM V-6 & V-8 (305 & 350 cid) engines (1993-2015) with Alpha

ENGINE COUPLER



18643A 7

Triangular shape, flywheel mount
Fits MCM GM V-6 & V-8 (305 & 350 cid) engines (1983-1993) & 454 Mag Alpha

ENGINE COUPLER



8M0098795

Round shape, flywheel mount
Fits MCM 4.5L MPI, 6.2L MPI (Mercury) & GM V-8 engines with Bravo drive

ENGINE COUPLER



8M0108208

Round shape, flywheel mount
Fits MCM 496 Mag & HO engines

8M0098796

Round shape, flywheel mount
Fits MCM 8.2L Mag & HO

861523A11

Use with metric or SAE attaching screws
Steel splines for low speed/work applications
Fits MCM GM V-8 engines with Bravo drives

ENGINE DRIVE PLATE



47608A 1

Round shape
Note: Will not work on 1986 & older GM V8 MIE applications with 12-3/4 in. flywheel
Fits MIE 215, 225, 233 & 255 Ford;
MIE & Tow Sports GM V-8 (305, 327 & 350 cid) engines

ENGINE DRIVE PLATE



862975A 1

Fits MIE 350 Mag, 454 Mag Horizon, 7.4L MPI & 8.2L MPI

862975A 2

Fits MIE 6.2L (s/n 2A456613 and up) and 8.1L MPI

ENGINE DRIVE PLATE



860125T

Fits MIE & Tow Sports GM V-8 engines

ENGINE DRIVE PLATE



8M0051206

Fits MCM 460 TRS, 575, 600 SC & 800 SC

MERCURY® MERCURISER®

MERCURY® MERCUISER® INTERNAL ENGINE

OIL PUMPS

OIL PUMP



36405

w/o pick-up tube
Fits MCM 120/2.5L, 140/3.0L/LX, & 160/165 (6 cyl)

OIL PUMP



13838A 1

Cast Iron
Fits MCM 3.7L engines

OIL PUMP



8M0114792

With pickup tube
Fits MCM 4.5L and 6.2L MPI Mercury built engines

OIL PUMP



17617

w/o pickup tube, 5/8" I.D. Pipe Hole
Fits MCM/MIE GM V-6 & V-8 (283, 305, 327 & 350 cid) engines (1995 & older)

OIL PUMP



809907002

w/o Pickup Tube (3/4 in. ID Pipe Hole)
Fits MCM/MIE GM V-6 & V-8 (305 & 350 cid) engines (1996-2016)

OIL PUMP



808693A 1

w/o Pickup Tube
Fits MCM/MIE 325, 330, 350, 350, 370, 390, 400, 440, 454 Mag & 7.4L

OIL PUMP



827643

w/ Pickup Tube
Fits MCM/MIE 330, 454 Mag, 465, 502 Mag, 600SC, 7.4L/LX & 8.2L

OIL PUMP



8M0051418

w/ Pickup Tube
Fits 2010 and newer MCM/MIE 8.2L

MERCURY® MERCUISER®

OIL PUMP



827589T 1

w/ Pickup Tube
Fits MCM 420, 425, 465, 500, 525SC & 600SC

OIL PUMP



98337T

w/ Pickup Tube
Fits MCM 460 TRS

OIL PUMP



8M0069808

w/ Pickup Tube
Fits MCM 496 Mag & HO; also MIE 8.1S & HO

OIL PUMP PICK-UP TUBES

PICK UP TUBE



52146

Fits 120/2.5L & 140/3.0L/LX

PICK UP TUBE



13843A 2

For the 13838A 1 oil pump
Fits MCM 3.7L engines

PICK UP TUBE



809908 1

3/4 in. OD Pipe
Fits MCM 4.3L/LX/LH/LXH & 262 Mag (1996-2016)

PICK UP TUBE



809909

3/4 in. OD Pipe
Fits MCM/MIE GM V-8 (305 & 350 cid) engines (1996-2015)

OIL PUMP PICKUP TUBE INSTALLATION TOOL



91 809929

Use with 5/8 in. (16 mm) pick up tubes

MERCURY® MERCURISER®

OIL PUMP PICKUP TUBE INSTALLATION TOOL



91-809938

Use with 3/4 in. (19 mm) pick up tubes

GASKET SETS - ENGINE OVERHAUL

OVERHAUL GASKET SET



27-801868

4 pc. Oil Pan Gasket
Fits MCM 120 (1964-1982)

OVERHAUL GASKET SET

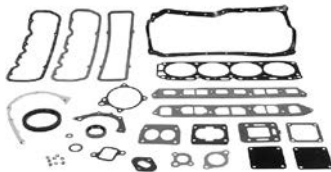

27-810846A05

1 pc. Oil Pan Gasket
Fits MCM 3.0L/LX (1990-2016)

OVERHAUL GASKET SET

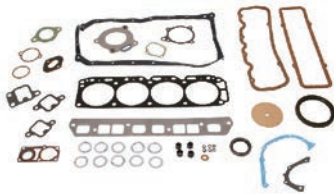

27-810846A06

Fits MCM 3.0L MPI (2008-2016)

OVERHAUL GASKET SET

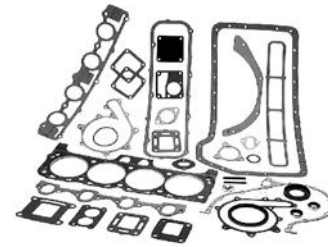

27-74830A 3

Fits MCM 470 & 485 (1976-1984)

OVERHAUL GASKET SET

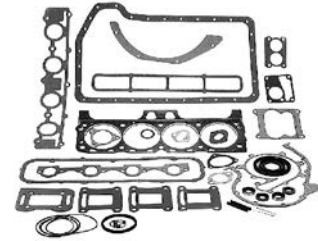

27-43186A 1

Fits MCM 3.7L engines (1983-1989)

OVERHAUL GASKET SET

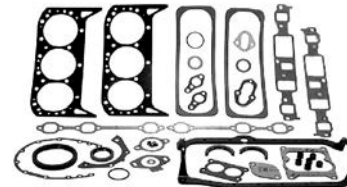

27-11977A92

Fits MCM 175, 185, 205, 4.3L/LX w/ 1 pc. rear main seal (1985-1993)

OVERHAUL GASKET SET

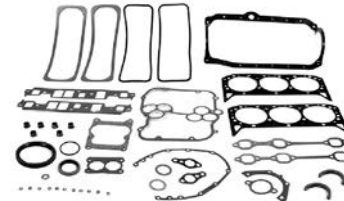

27-824326A93

Fits MCM 4.3L/LX Gen II (1993-1996)

MERCURY® MERCURUISER®

OVERHAUL GASKET SET



27-824326A02

Fits MCM 4.3L/LX/LH/LHX & 262 Mag (Gen+) (1A063239 and below)

OVERHAUL GASKET SET

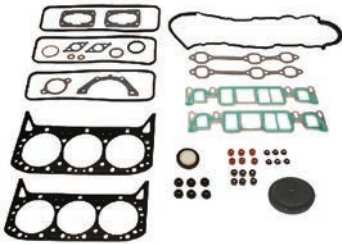

27-824326A03

Fits MCM 4.3L (s/n 1A063240 thru 2A454127)

OVERHAUL GASKET SET

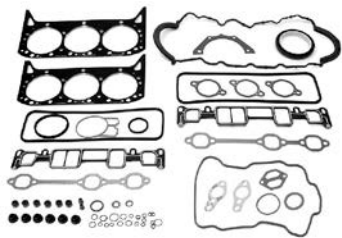

27-807756A01

Fits MCM 4.3L MPI (1A036239 and below)

OVERHAUL GASKET SET



27-807756A02

Fits MCM 4.3L MPI (1A063240 thru 2A528897)

OVERHAUL GASKET SET

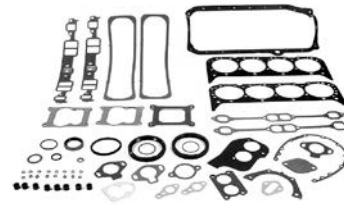

27-75611A88

Fits MCM/MIE 200, 230, 260, 350 Mag, 5.0L/LX & 5.7L (1987-1995)

OVERHAUL GASKET SET



27-861246A05

Fits MCM/MIE 5.0L & 5.7L (Gen+) (1998-2015)

OVERHAUL GASKET SET



27-861246A06

Fits MCM/MIE 5.0L, 5.7L & 6.2L EC engines (2008-2015)

OVERHAUL GASKET SET

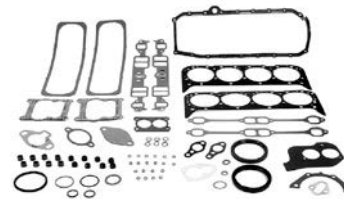

27-806871A96

Fits MCM/MIE 260, 350 Mag & 5.7L/LX (1991-1997)

MERCURY® MERCURISER®

OVERHAUL GASKET SET

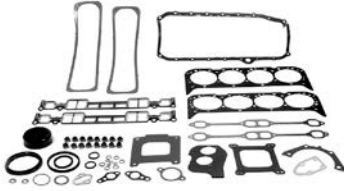

27- 75611A96

Fits MCM/MIE 5.7L/LX EFI & 350 Mag EFI (Gen+) (1996-1997)

OVERHAUL GASKET SET

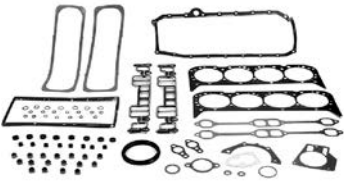

27- 807670A96

Fits MCM 350 Mag MPI, Black Scorpion Tow Sports & 377 Scorpion Tow Sports (Gen+) (1996-2015)

OVERHAUL GASKET SET

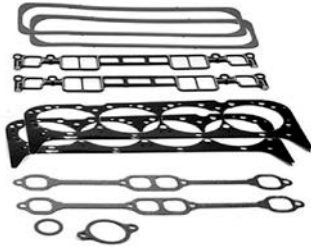

27- 75611A98

Fits MIE & Tow Sports 350 Mag MPI (Gen+) (1998-2001)

OVERHAUL GASKET SET

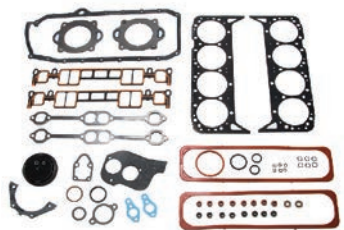

27- 861246A99

Fits Tow Sports 5.7L EC engines (2008-2015)

OVERHAUL GASKET SET

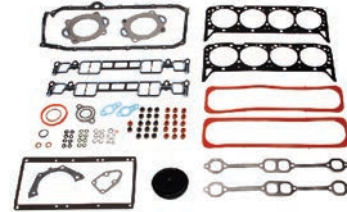

27- 807670A03

Fits Tow Sports Scorpion 350 & 377 EC engines (2008-2015)

OVERHAUL GASKET SET

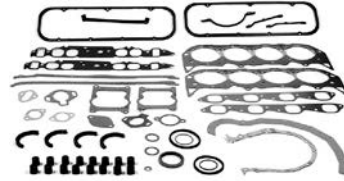

27- 65184A88

(RH or LH) Rotation
Fits MCM/MIE 330, 340, 7.4L & 454 Mag Alpha (1977-1992)

OVERHAUL GASKET SET



27- 811547A92

Fits MCM 7.4L & 454 Mag (Gen V) (1992-1996)

OVERHAUL GASKET SET

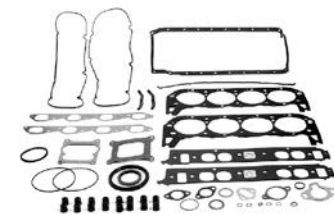

27- 850470A96

Fits MCM/MIE 7.4L (Gen VI) (1996-1997)

OVERHAUL GASKET SET

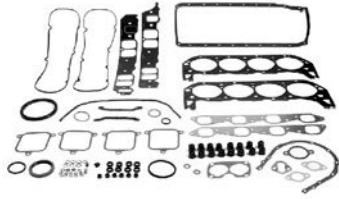

27-805396A95

Fits MCM/MIE 7.4L LX MPI (Gen V & VI) (1995-1997)

OVERHAUL GASKET SET

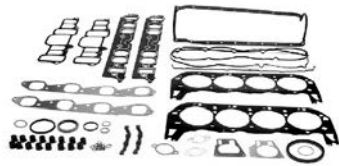

27-802567A98

Fits MCM/MIE 7.4L MPI (L29-Gen VI) (1998-2001)

GASKET SET



27-811572A94

Fits MCM 454 Mag (Gen VI) (1996-2001)

OVERHAUL GASKET SET

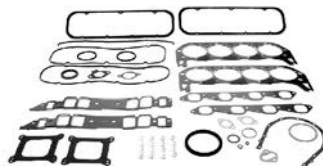

27-818572A98

Fits 454 EFI Tow Sports; MCM 450 & 500 (Gen V & VI) (1994-1997)

OVERHAUL GASKET SET

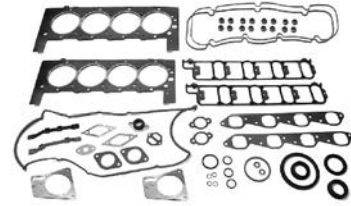

27-889924A01

Fits MCM 496 Mag & HO; also MIE 8.1S & HO

27-889924A02

Fits MCM 496 Mag & HO; also MIE 8.1S & HO

OVERHAUL GASKET SET

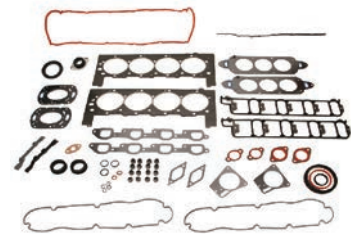

27-889924A03

Fits MCM 496 Mag & HO EC engines; also MIE 8.1S & HO EC engines

OVERHAUL GASKET SET

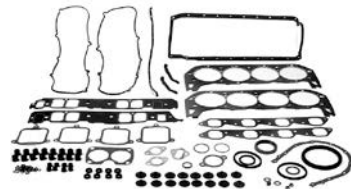

27-805396A92

Fits MCM 502 Mag MPI & MIE 8.2L MPI (Gen VI) (1996-2001)

OVERHAUL GASKET SET

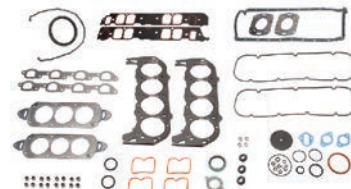

27-8M0045578

Fits 2010 and newer MCM/MIE 8.2L

MERCURY® MERCURISER®

OVERHAUL GASKET SET

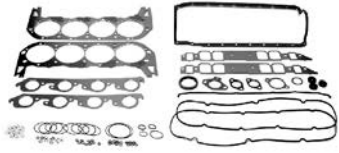

27-842129A 1

Fits MCM 500 EFI

OVERHAUL GASKET SET

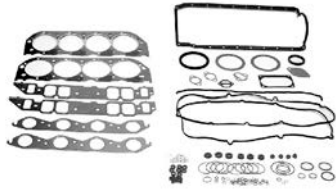

27-843073A06

Fits MCM 525 EFI

OVERHAUL GASKET SET

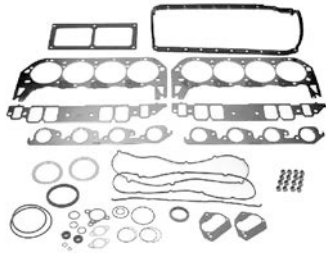

27-842182A 1

Fits MCM 575 SCi (2000-2001)

WATER PUMP GASKET

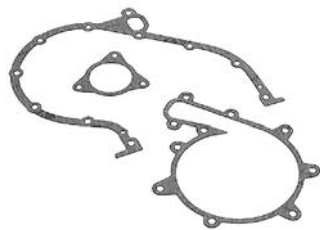

27-68714A 7

Fits MCM 3.7L engines

HEAD GASKETS

CYLINDER HEAD GASKET SET

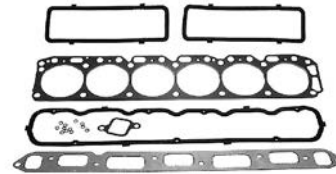

27-47453A 1

Fits MCM GM in-line 6 cyl.

CYLINDER HEAD GASKET SET



27-75611A 2

Fits MCM/MIE GM V-8 (305 & 350 cid) engines (1986 & older)

CYLINDER HEAD GASKET SET

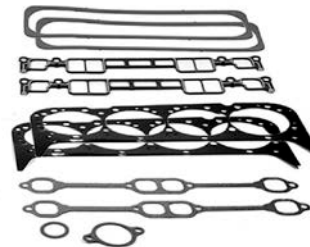

27-75611A03

Fits MCM/MIE GM V-8 (305, 350 & 377 cid) Gen + engines (1996-2015)

MERCURY® MERCUISER®

MERCURY® MERCUISER® TRANSOM

GIMBAL RING KITS

GIMBAL RING KIT



88302A 1

Complete kit to convert the gimbal ring from a spline/splined upper shaft to a square/splined upper shaft. Also can be used to service a square gimbal ring with a splined steering arm.
Fits MCM I drives (1978-1983)

GIMBAL RING KIT



94993A12

Fits R/MR/Alpha One drives (1983-1990)

GIMBAL RING KIT



8M0061384

Used to convert standard Bravo gimbal ring to heavy duty gimbal ring and bell housings. Trim limit switch cannot be used on HD gimbal ring.
Fits MCM Bravo drives

GIMBAL HOUSING ACCESS PLUG KIT



22- 88847A 1

This kit allows removal and installation of gimbal ring without having to remove the engine & transom assembly. Templates are included to help locate the access holes.
For use with MC-I, R, MR, Alpha, Bravo, TR & TRS sterndrives

ENGINE MOUNTING HARDWARE

REAR ENGINE MOUNT BOLT KIT



10- 97934A 1

Fits R, MR, Alpha One, Gen II & Bravo drives

REAR ENGINE MOUNT



8M0103028

Standard durometer
Fits MCM flywheel housing with Alpha and Bravo drives

MERCURY® MERCUISER®

REAR ENGINE MOUNT



865330A02

Stiffer durometer for higher hp engines.
Fits MCM flywheel housing with Bravo drive

STERNDRIVE INSTALLATION HARDWARE

STERNDRIVE INSTALLATION HARDWARE



11-859116K01

For mounting the MC-I, R, MR, Alpha & Bravo drives to the bell housing.
Priced individually, sold @ multiples of 2
Mercury Branded, Clamshell Package Point of Sale Packaged.

11-859116Q01

For mounting the MC-I, R, MR, Alpha & Bravo drives to the bell housing.
Priced individually, sold @ multiples of 2
Quicksilver Branded, Clamshell Package Point of Sale Packaged.

SHIFT CABLE KITS

SHIFT CABLE KIT



865436A03

Fits MC-I, R, MR, Alpha One & Gen II (1978 & newer)

SHIFT CABLE KIT



815471T 1

Fits Bravo

SHIFT CABLES

SHIFT CABLE



73723A01

Fits IA/IB/IC, EZ-Shift & MC-I (1977 & older)

SHIFT CABLE



865436A02

Fits MC-I, R, MR, Alpha One & Gen II (1978 & newer)

SHIFT CABLE



33981A06

Fits Vazer

SHIFT CABLE

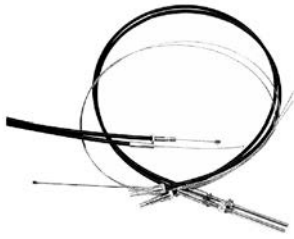

865437A02

Fits Bravo

DRIVE INSTALLATION GASKET KITS

DRIVE INSTALLATION KIT



27- 35996A 1

Fits IA/IB/IC & EZ Shift (1964-1966)

DRIVE INSTALLATION KIT



27- 64818T 4

Fits MC-I drives (s/n 6225576 & below) (1967-1982)
Mercury Branded, Peg Display Card Point of Sale Packaged.

27- 64818Q 4

Fits MC-I drives (s/n 6225576 & below) (1967-1982)
Quicksilver Branded, Peg Display Card Point of Sale Packaged.

DRIVE INSTALLATION KIT



27- 94996T 2

Fits R, MR, Alpha One & Gen II drives (s/n 6225577 and above) (1983 & newer)
Mercury Branded, Peg Display Card Point of Sale Packaged.

27- 94996Q 2

Fits R, MR, Alpha One & Gen II drives (s/n 6225577 and above) (1983 & newer)
Quicksilver Branded, Peg Display Card Point of Sale Packaged.

DRIVE INSTALLATION KIT



27- 866449A01

Fits Vazer

DRIVE INSTALLATION KIT

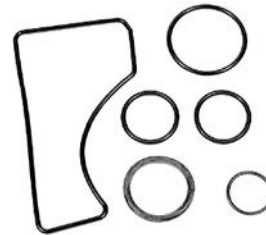

16755T 1

Fits Bravo drives.
Priced individually, sold @ multiples of 2
Mercury Branded, Clamshell Package Point of Sale Packaged.

16755Q 1

Fits Bravo drives.
Priced individually, sold @ multiples of 2
Quicksilver Branded, Clamshell Package Point of Sale Packaged.

DRIVE INSTALLATION KIT



27- 54014Q 1

Fits 215E, 215H, TR and TRS drives.
Quicksilver Branded, Peg Display Card Point of Sale Packaged.

MERCURY® MERCRUISER®

TRANSOM SEAL REPAIR KITS

TRANSOM SEAL REPAIR KIT



30-803097T 1

Fits R, MR & Alpha One w/ exhaust bellows

TRANSOM SEAL REPAIR KIT



30-803098T 1

Fits R, MR & Alpha One w/ exhaust tube

TRANSOM SEAL REPAIR KIT



30-803099T 1

Fits Alpha One Gen II

TRANSOM SEAL REPAIR KIT



8M0095485

Fits Bravo & Blackhawk

SHIFT CABLE BELLOWS

SHIFT CABLE BELLOWS



74639A 2

Includes clamps
Fits all MCM sterndrives utilizing a drive unit shift cable. (1963 & newer)

74639Q02

Includes clamps
Fits all MCM sterndrives utilizing a drive unit shift cable. (1963 & newer)
Priced individually, sold @ multiples of 2
Quicksilver Branded, Clamshell Package Point of Sale Packaged.

MERCURY® MERCUISER®

TRANSOM GASKET AND SEAL CHART

Stern Drive Installation Gaskets

Model	Year Range	Serial # Range	Bell Housing Gasket Set	Bell Housing O-Ring	Bell Housing Rubber Seal	Transom Seal Repair Kit	Transom Seal/Gasket Kit
60/80/90	1965 - 1966	1830753 - 2063740	N.L.A.	N.L.A.	N.L.A.	N/A	N.L.A.
I	1963	1534570 - 1684187	N.L.A.	25-33504	N/A	N/A	27-70974
IA/IB/IC & EZ-Shift	1964 - 1966	1684188 - 2065186	27-35996A 1	25-33504	27-35982	N/A	27-70974
120/140	1967 - 1973	2062141 - 3780849	27-64818Q 4	25-33504	27-35982	N/A	27-70974
120/140	1974 - 1977	3780850 - 4893634	27-64818Q 4	25-33504	27-35982	N/A	27-65373
120/140	1978 - 1982	4893635 - 6225576	27-64818Q 4	25-33504	27-35982	N/A	65533A 1
470/485	1976 - 1982	4208730 - 6225575	27-64818Q 4	25-33504	27-35982	N/A	65533A 1
160/165	1967 - 1973	2065190 - 3780849	27-64818Q 4	25-33504	27-35982	N/A	27-70974
165	1974 - 1977	3780850 - 4890459	27-64818Q 4	25-33504	27-35982	N/A	27-65373
165	1978 - 1981	4890460 and up	27-64818Q 4	25-33504	27-35982	N/A	65533A 1
888	1971 - 1977	3106717 and up	27-64818Q 4	25-33504	27-35982	N/A	27-65373(3)
888	1974 - 1977	3106717 and up	27-64818Q 4	25-33504	27-35982	N/A	65533A 1(4)
225/233	1974 - 1977	3856268 and up	27-64818Q 4	25-33504	27-35982	N/A	27-65373(3)

Not all parts listed are available for the European, C.I.S., Africa and Middle East Markets.
For more information, please contact your local Mercury, Mariner, MerCruiser or Quicksilver Office.

MERCURY® MERCUISER® TRANSOM

Model	Year Range	Serial # Range	Bell Housing Gasket Set	Bell Housing O-Ring	Bell Housing Rubber Seal	Transom Seal Repair Kit	Transom Seal/Gasket
225/233	1974 - 1977	3856268 and up	27- 64818Q 4	25- 33504	27- 35982	N/A	65533A 1(4)
898/228	1977 - 1982	4782330 - 6225576	27- 64818Q 4	25- 33504	27- 35982	N/A	65533A 1
250/260	1977 - 1982	4791300 - 6225576	27- 64818Q 4	25- 33504	27- 35982	N/A	65533A 1
R, MR, Alpha One	1983 - 1990	6225577 - 0D469858	27- 94996Q 2	25- 33504	27- 35982	30-803097T 1(2)	65533A 1
R, MR, Alpha One	1983 - 1990	6225577 - 0D469858	27- 94996Q 2	25- 33504	27- 35982	30-803098T 1(1)	65533A 1
Alpha One SS	1986 - 1989	0A545004 and up	27- 94996Q 2	25- 33504	27- 35982	30-803097T 1(2)	65533A 1
Alpha One SS	1986 - 1989	0A545004 and up	27- 94996Q 2	25- 33504	27- 35982	30-803098T 1(1)	65533A 1
Alpha One Gen II	1991 - 2019	0D469859 and up	27- 94996Q 2	25- 33504	27- 35982	30-803099T 1	43713
Bravo I/II/III	1988 - 2019	0B664190 and up	16755Q 1	25- 45710 1	N/A	8M0095485	43713
Blackhawk	1994 - 1995	0F186717 and up	16755Q 1	25- 45710 1	N/A	8M0095485	43713
II	1962 - 1969	1474909 - 2671321	N/A	N/A	N/A	N/A	N.L.A.
III	1968 - 1972	2373127 - 3002613	N/A	25- 31534	N/A	N/A	27- 47366T
215E/H	1970 - 1972	2782203 - 2915034	27- 54014Q 1	N/A	N/A	N/A	27- 54395T
TR/TRS	1973 - 1993	3377316 and up	27- 54014Q 1	N/A	N/A	N/A	27- 54395T

(1) With exhaust tube

(2) With exhaust bellows

(3) Gimbal ring without trim sender

(4) Gimbal ring with trim sender

MERCURY® MERCUISER®

MERCURY® MERCUISER® DRIVE SYSTEMS

U-JOINT AND COMPONENTS

CROSS & BEARING



75832T 1

Fits IA/IB/IC & EZ, MC-I, R, MR, Alpha One & Gen II, Bravo (s/n 0M111207 and below) and MC II & TR/TRS

CROSS & BEARING



805536A 2

Fits Alpha One Gen II (s/n 0D870000-0M400411)

CROSS & BEARING



865496A02

Fits Alpha One Gen II (s/n 0M400412 and above), Bravo (s/n 0M111208 and above) and Vazer

CROSS & BEARING



862132T

NLA - Order complete U-joint Assembly 865425A03
1.328 in. O.D. caps
Fits Bravo X/XR/XZ drives w/ the Meritor U-Joint assembly (s/n 0M750174 and below)

CROSS & BEARING



866136A01

1.218 in. O.D. caps
Fits Bravo X/XR/XZ drives w/ the GKN U-Joint assembly (s/n 0M750175 and above)

GEAR REPAIR KITS - DRIVESHAFT HOUSING

UPPER GEAR REPAIR KIT



43-803115T 1

20-16 teeth, 1.32 ratio
Fits R, MR, Alpha One & SS (1983-1990)

43-803116T 1

22-20 teeth, 1.50 ratio
Fits R, MR, Alpha One & SS (1983-1990)

43-803112T 1

24-24 teeth, 1.65 ratio
Fits R, MR & Alpha One (1983-1990)

43-803114T 1

17-19 teeth, 1.84 ratio
Fits R, MR & Alpha One (1983-1990)

43-803101T 1

20-24 teeth, 1.98 ratio
Fits R, MR & Alpha One (1983-1990)

UPPER GEAR REPAIR KIT



43-803102T 1

22-20 teeth, 1.47 ratio
Fits Alpha One Gen II (s/n 0D469856-0K999999) (1991-1997)

43-803103T 1

22-20 teeth, 1.47 ratio
Fits Alpha One Gen II (s/n 0L100040 and above) (1998 & newer)

43-803104T 1

24-24 teeth, 1.62 & 2.00 ratio
Fits Alpha One Gen II (s/n 0L100040 and above) (1998 & newer)

43-803119T 1

24-24 teeth, 1.62 ratio
Fits Alpha One Gen II (s/n 0D469856-0K999999) (1991-1997)

43-803105T 1

17-19 teeth, 1.81 ratio
Fits Alpha One Gen II (s/n 0L100040 and above) (1998 & newer)

43-803120T 1

17-19 teeth, 1.81 ratio
Fits Alpha One Gen II (s/n 0D469856-0K999999) (1991-1997)

43-803106T 1

20-24 teeth, 1.94 & 2.40 ratio
Fits Alpha One Gen II (s/n 0L100040 and above) (1998 & newer)

43-803118T 1

20-24 teeth, 1.94 & 2.40 ratio
Fits Alpha One Gen II (s/n 0D469856-0K999999) (1991-1997)

UPPER GEAR REPAIR KIT



43-803108T 2

27-29 teeth
Note: May require new replacement shims to be ordered separately, see MCM Service Bulletin 2001-17
Fits Bravo I (1.36), II (1.50 & 1.81) & III (1.36 & 1.81) (s/n 0B664190-0L999999) (1988-1999)

43-803107T 2

27-32 teeth
Note: May require new replacement shims to be ordered separately, see MCM Service Bulletin 2001-17
Fits Bravo I (1.50), II (1.65 & 2.00) & III (1.50, 1.65 & 2.00) (s/n 0B664190-0L999999) (1988-1999)

43-803109T 2

23-30 teeth
Note: May require new replacement shims to be ordered separately, see MCM Service Bulletin 2001-17
Fits Bravo I (1.65), II (2.20) & III (2.20 & 2.43) (s/n 0B664190-0L999999) (1988-1999)

GEAR SETS - DRIVESHAFT HOUSING

UPPER GEAR KIT



43-45569A 5

24-24 teeth, 1.68 ratio
Fits 160 (1967-1969)

UPPER GEAR KIT



43-8M0080756

20-16 teeth, 1.32 ratio
Fits MC-I, R, MR, Alpha One & SS (1975-1990)

UPPER GEAR KIT



43-18411A 4

For use w/ heavy duty 1.50 gears only. The HD 1.50 drive gear has a stepped bearing surface requiring the use of a special bearing kit having 2 different I.D. bearings.
Fits MR, Alpha One & SS (1984-1990)

UPPER GEAR KIT



43-18411A 2

22-20 teeth, 1.50/1.47 ratio
Fits MC-I, R, MR, Alpha One & Gen II (s/n 0K999999 and below) (1971-1997)

UPPER GEAR KIT



43-45814A 5

24-24 teeth, 1.65/1.62 ratio
Fits MC-I, R, MR, Alpha One & Gen II (s/n 0K999999 and below) (1970-1997)

UPPER GEAR KIT



43-75325A 3

17-19 teeth, 1.84/1.81 ratio
Fits MC-I, R, MR, Alpha One & Gen II (s/n 0K999999 and below) (1976-1997)

UPPER GEAR KIT



43-55778A 3

20-24 teeth, 1.98/1.94 & 2.40 ratio
Fits MC-I, R, MR, Alpha One & Gen II (s/n 0K999999 and below) (1970-1997)

UPPER GEAR KIT



43-853641A 2

22-20 teeth, 1.47 ratio
Fits Alpha One Gen II (s/n 0L000040 and above) (1998 & newer)

UPPER GEAR KIT



43-853640A 2

24-24 teeth, 1.62 & 2.00 ratio
Fits Alpha One Gen II (s/n 0L000040 and above) (1998 & newer)

UPPER GEAR KIT



43-853643A 2

17-19 teeth, 1.81 ratio Alpha One Gen II;
2.58 ratio Vazer
Fits Alpha One Gen II (s/n 0L000040 and above) (1998 & newer) & Vazer drive

UPPER GEAR KIT



43-853642A 2

20-24 teeth, 1.94 & 2.40 ratio Alpha One Gen II;
2.77 ratio Vazer
Fits Alpha One Gen II (s/n 0L000040 and above) (1998 & newer) and Vazer drive

UPPER GEAR KIT



43-883476A 4

27-29 teeth
Note: May require new replacement shims to be ordered separately, see MCM Service Bulletin 2001-17
Fits Bravo I (1.36), II & III (1.81) (s/n 0B664190-0F729999) (1988-1995)

43-883473A 4

27-32 teeth

Note: May require new replacement shims to be ordered separately, see MCM Service Bulletin 2001-17

Fits Bravo I (1.50), II (2.00) & III (1.50, 1.65 & 2.00) (s/n 0B664190-0F729999) (1988-1995)

43-883479A 4

23-30 teeth

Note: May require new replacement shims to be ordered separately, see MCM Service Bulletin 2001-17

Fits Bravo I (1.65 ratio), II & III (2.20 ratio) (s/n 0B664190-0F729999) (1988-1995)

UPPER GEAR KIT



43-883476A 3

27-29 teeth, Gas & Diesel applications

Note: May require new replacement shims to be ordered separately, see MCM Service Bulletin 2001-17

Fits Bravo I & Perf. (1.36), II (1.50 & 1.81) & III (1.36 & 1.81) (s/n 0F730000-0M100000) (1996-1999)

43-883473A 3

27-32 teeth, Gas & Diesel applications

Note: May require new replacement shims to be ordered separately, see MCM Service Bulletin 2001-17

Fits Bravo I & Perf. (1.50), II (1.65 & 2.00) & III (1.50, 1.65 & 2.00) (s/n 0F730000-0M100000) (1996-1999)

43-883479A 3

23-30 teeth, Gas & Diesel applications

Note: May require new replacement shims to be ordered separately, see MCM Service Bulletin 2001-17

Fits Bravo I & Perf. (1.65), II (2.20) & III (2.20 & 2.43) (s/n 0F730000-0M100000) (1996-1999)

UPPER GEAR KIT



43-883476A 2

27/29 teeth, High bump

Fits Bravo I & Perf. (1.36), II (1.50 & 1.81) & III (1.36 & 1.81) (0M100001-0W249999). Also Bravo I (1.36), II (1.50) & III (1.36) 0W250000 and up

43-883473A 2

27/32 teeth, High bump

Fits Bravo I & Perf. (1.50), II (1.65 & 2.00) & III (1.50, 1.65 & 2.00) (0M100001-0W249999). Also Bravo III (1.50) (0W250000 and up)

43-883479A 2

23/30 teeth, High bump

Fits Bravo I & Perf. (1.65), II (2.20) & III (2.20 & 2.43) (0M100001-0W249999)

43-8M0060003

27/32 teeth, Low Bump

Fits Bravo I (1.50), II (1.65 & 2.00) & III (1.65 & 2.00) (0W250000 and up)

43-8M0060004

27/29 teeth, Low bump

Fits Bravo II (1.81) & III (1.81) (0W250000 and up)

43-8M0060005

23/30 teeth, Low bump

Fits Bravo I (1.65), II (2.20) & III (2.20 & 2.43) (0W250000 and up)

UPPER GEAR KIT



43-887906A 1

27/29 teeth

Fits Bravo I X & XZ (1.36), II X (1.50 & 1.81) & III X (1.36 & 1.81) (2000 & newer)

43-887903A 1

27/32 teeth

Fits Bravo I X & XZ (1.50), II X (1.65 & 2.00) & III X (1.50, 1.65 & 2.00) (2000 & newer)

43-887909A 1

23/30 teeth

Fits Bravo I X (1.65), II X (2.20) & III X (2.20 & 2.43) (2000 & newer)

UPPER GEAR KIT



43-840898A 3

19/16 teeth

Fits Bravo I XR (2000 & newer)

GEARS - DRIVESHAFT HOUSING

UPPER DRIVEN GEAR



43-62879T 1

32 teeth

Fits TR/TRS

GEAR CHART - DRIVESHAFT HOUSING

Drive Shaft Housing Gears

Model	Gear Ratio	Year Range	Serial # Range	Drive Gear	Driven Gear/ Gear Kit	Upper Gear Repair Kit
IA & EZ Shift	1.84	1964 - 1966	1684188 - 2065186	N.S.S.	N.L.A.	N/A
IB & EZ Shift	2.01	1964 - 1966	1684188 - 2065186	N.S.S.	N.L.A.	N/A
IC & EZ Shift	1.68	1964 - 1966	1684188 - 2065186	N.S.S.	N.L.A.	N/A
120/140	1.98	1967 - 1969	2062141 - 2791956	N.S.S.	N.L.A.	N/A
120/140	1.98	1970 - 1982	2791957 - 6225576	N.S.S.	43- 55778A 3	N/A
470/485	1.84	1976 - 1982	4208730 - 6225575	N.S.S.	43- 75325A 3	N/A
160	1.68	1967 - 1969	2065190 - 2763441	N.S.S.	43- 45569A 5	N/A
165	1.65	1970 - 1981	2763442 and up	N.S.S.	43- 45814A 5	N/A
888	1.50	1971 - 1977	3106717 and up	N.S.S.	43- 18411A 2	N/A
225-S	1.50	1974	3856268 - 4200499	N.S.S.	43- 18411A 2	N/A
233	1.32	1975 - 1977	4200500 and up	N.S.S.	43- 8M0080756	N/A
898/228	1.50	1977 - 1982	4782330 - 6225576	N.S.S.	43- 18411A 2	N/A
250	1.32	1977	4791300 - 4898729	N.S.S.	43- 8M0080756	N/A
260	1.50	1978 - 1982	4898730 - 6225576	N.S.S.	43- 18411A 2	N/A
R/MR/Alpha One	1.98	1983 - 1990	6225577 - 0D469858	N.S.S.	43- 55778A 3	43-803101T 1
R/MR/Alpha One	1.84	1983 - 1990	6225577 - 0D469858	N.S.S.	43- 75325A 3	43-803114T 1
R/MR/Alpha One	1.65	1983 - 1990	6225577 - 0D469858	N.S.S.	43- 45814A 5	43-803112T 1
R/MR/Alpha One	1.50	1983 - 1990	6225577 - 0D469858	N.S.S.	43- 18411A 2	43-803116T 1(1)
R/MR/Alpha One	1.50 HD	1983 - 1990	6225577 - 0D469858	N.S.S.	43- 18411A 4	43-803116T 1
R/MR/Alpha One	1.32	1983 - 1990	6225577 - 0D469858	N.S.S.	43- 8M0080756	43-803115T 1
Alpha One SS	1.50	1986 - 1989	0A545004 and up	N.S.S.	43- 18411A 4	43-803116T 1
Alpha One SS	1.32	1986 - 1989	0A545004 and up	N.S.S.	43- 8M0080756	43-803115T 1
Alpha One Gen II	2.40	1991 - 1997	0D469859 - 0K999999	N.S.S.	43- 55778A 3	43-803118T 1
Alpha One Gen II	1.98/1.94	1991 - 1997	0D469859 - 0K999999	N.S.S.	43- 55778A 3	43-803118T 1
Alpha One Gen II	1.65/1.62	1991 - 1997	0D469859 - 0K999999	N.S.S.	43- 45814A 5	43-803119T 1
Alpha One Gen II	1.84/1.81	1991 - 1997	0D469859 - 0K999999	N.S.S.	43- 75325A 3	43-803120T 1
Alpha One Gen II	1.50/1.47	1991 - 1997	0D469859 - 0K999999	N.S.S.	43- 18411A 2	43-803102T 1
Alpha One Gen II	2.40	1998 - 2019	0L100040 and up	N.S.S.	43- 853642A 2	43-803106T 1
Alpha One Gen II	2.00	1998 - 2019	0L100040 and up	N.S.S.	43- 853640A 2	43-803104T 1
Alpha One Gen II	1.94	1998 - 2019	0L100040 and up	N.S.S.	43- 853642A 2	43-803106T 1
Alpha One Gen II	1.81	1998 - 2019	0L100040 and up	N.S.S.	43- 853643A 2	43-803105T 1
Alpha One Gen II	1.62	1998 - 2019	0L100040 and up	N.S.S.	43- 853640A 2	43-803104T 1
Alpha One Gen II	1.47	1998 - 2019	0L100040 and up	N.S.S.	43- 853641A 2	43-803103T 1
Vazer	2.77	2007 - 2009	0W995000 and up	N.S.S.	43- 853642A 2	N/A
Vazer	2.58	2007 - 2009	0W995000 and up	N.S.S.	43- 853643A 2	N/A
Bravo I	1.65	1988 - 1995	0B664190 - 0F729999	N.L.A.(2)	43- 883479A 4	43-803109T 2
Bravo I	1.65	1996 - 1999	0F730000 - 0M100000	N.L.A.(3)	43- 883479A 3	43-803109T 2
Bravo I	1.65	2000 - 2004	0M100001 - 0W249999	N.S.S.	43- 883479A 2	N/A
Bravo I	1.65	2004 - 2019	0W250000 and up	N.S.S.	43- 8M0060005	N/A
Bravo I	1.50	1988 - 1995	0B664190 - 0F729999	N.L.A.(4)	43- 883473A 4	43-803107T 2
Bravo I	1.50	1996 - 1999	0F730000 - 0M100000	N.L.A.(5)	43- 883473A 3	43-803107T 2
Bravo I	1.50	2000 - 2004	0M100001 - 0W249999	N.S.S.	43- 883473A 2	N/A
Bravo I	1.50	2004 - 2019	0W250000 and up	N.S.S.	43- 8M0060003	N/A
Bravo I	1.36	1988 - 1995	0B664190 - 0F729999	N.L.A.(6)	43- 883476A 4	43-803108T 2
Bravo I	1.36	1996 - 1999	0F730000 - 0M100000	N.L.A.(7)	43- 883476A 3	43-803108T 2
Bravo I	1.36	2000 - 2019	0M100001 and up	N.S.S.	43- 883476A 2	N/A
Bravo I - Diesel	1.65	1996 - 1999	0F730000 - 0M100000	N.S.S.	43- 883479A 3	N/A
Bravo I - Diesel	1.50	1996 - 1999	0F730000 - 0M100000	N.S.S.	43- 883473A 3	N/A
Bravo I - Diesel	1.36	1996 - 1999	0F730000 - 0M100000	N.S.S.	43- 883476A 3	N/A

MERCURY® MERCRUISER® DRIVE SYSTEMS

MERCURY® MERCRUISER®

Model	Gear Ratio	Year Range	Serial # Range	Drive Gear	Driven Gear/ Gear Kit	Upper Gear Repair Kit
Bravo I Performance	1.65	1998 - 1999	0L000000 - 0M100000	N.L.A.(3)	43-883479A 3	N/A
Bravo I Performance	1.65	2000 - 2019	0M100001 and up	N.S.S.	43-883479A 2	N/A
Bravo I Performance	1.50	1998 - 1999	0L000000 - 0M100000	N.L.A.(5)	43-883473A 3	N/A
Bravo I Performance	1.50	2000 - 2019	0M100001 and up	N.S.S.	43-883473A 2	N/A
Bravo I Performance	1.36	1998 - 1999	0L000000 - 0M100000	N.L.A.(7)	43-883476A 3	N/A
Bravo I Performance	1.36	2000 - 2019	0M100001 and up	N.S.S.	43-883476A 2	N/A
Bravo I X	1.65	2000 - 2019	0M100001 and up	N.S.S.	43-887909A 1	N/A
Bravo I X	1.50	2000 - 2019	0M100001 and up	N.S.S.	43-887903A 1	N/A
Bravo I X	1.36	2000 - 2019	0M100001 and up	N.S.S.	43-887906A 1	N/A
Bravo I XR	1.26	2000 - 2019	0M100001 and up	43-849320T	43-840898A 3	N/A
Bravo I XR	1.35	2000 - 2019	0M100001 and up	43-849320T	43-840898A 3	N/A
Bravo I XR	1.50	2000 - 2019	0M100001 and up	43-849320T	43-840898A 3	N/A
Bravo I XZ	1.50	2000 - 2019	0M100001 and up	N.S.S.	43-887903A 1	N/A
Bravo I XZ	1.36	2000 - 2019	0M100001 and up	N.S.S.	43-887906A 1	N/A
Bravo II	2.20	1988 - 1995	0B664190 - 0F729999	N.L.A.(2)	43-883479A 4	43-803109T 2
Bravo II	2.20	1996 - 1999	0F730000 - 0M100000	N.L.A.(3)	43-883479A 3	43-803109T 2
Bravo II	2.20	2000 - 2004	0M100001 - 0W249999	N.S.S.	43-883479A 2	N/A
Bravo II	2.20	2004 - 2019	0W250000 and up	N.S.S.	43-8M0060005	N/A
Bravo II	2.00	1988 - 1995	0B664190 - 0F729999	N.L.A.(4)	43-883473A 4	43-803107T 2
Bravo II	2.00	1996 - 1999	0F730000 - 0M100000	N.L.A.(5)	43-883473A 3	43-803107T 2
Bravo II	2.00	2000 - 2004	0M100001 - 0W249999	N.S.S.	43-883473A 2	N/A
Bravo II	2.00	2004 - 2019	0W250000 and up	N.S.S.	43-8M0060003	N/A
Bravo II	1.81	1988 - 1995	0B664190 - 0F729999	N.L.A.(6)	43-883476A 4	43-803108T 2
Bravo II	1.81	1996 - 1999	0F730000 - 0M100000	N.L.A.(7)	43-883476A 3	43-803108T 2
Bravo II	1.81	2000 - 2004	0M100001 - 0W249999	N.S.S.	43-883476A 2	N/A
Bravo II	1.81	2004 - 2019	0W250000 and up	N.S.S.	43-8M0060004	N/A
Bravo II	1.65	1996 - 1999	0F730000 - 0M100000	N.L.A.(4)	43-883473A 3	43-803107T 2
Bravo II	1.65	2000 - 2004	0M100001 - 0W249999	N.S.S.	43-883473A 2	N/A
Bravo II	1.65	2004 - 2019	0W250000 and up	N.S.S.	43-8M0060003	N/A
Bravo II	1.50	1996 - 1999	0F730000 - 0M100000	N.L.A.(7)	43-883476A 3	43-803108T 2
Bravo II	1.50	2000 - 2019	0M100001 and up	N.S.S.	43-883476A 2	N/A
Bravo II - Diesel	2.20	1996 - 1999	0F730000 - 0M100000	N.S.S.	43-883479A 3	N/A
Bravo II - Diesel	2.00	1996 - 1999	0F730000 - 0M100000	N.S.S.	43-883473A 3	N/A
Bravo II - Diesel	1.81	1996 - 1999	0F730000 - 0M100000	N.S.S.	43-883476A 3	N/A
Bravo II - Diesel	1.65	1996 - 1999	0F730000 - 0M100000	N.S.S.	43-883473A 3	N/A
Bravo II - Diesel	1.50	1996 - 1999	0F730000 - 0M100000	N.S.S.	43-883476A 3	N/A
Bravo II X	2.20	2000 - 2019	0M100001 and up	N.S.S.	43-887909A 1	N/A
Bravo II X	2.00	2000 - 2019	0M100001 and up	N.S.S.	43-887903A 1	N/A
Bravo II X	1.81	2000 - 2019	0M100001 and up	N.S.S.	43-887906A 1	N/A
Bravo II X	1.65	2000 - 2019	0M100001 and up	N.S.S.	43-887903A 1	N/A
Bravo II X	1.50	2000 - 2019	0M100001 and up	N.S.S.	43-887906A 1	N/A
Bravo III	2.43	1996 - 1999	0F730000 - 0M100000	N.L.A.(3)	43-883479A 3	43-803109T 2
Bravo III	2.43	2000 - 2004	0M100001 - 0W249999	N.S.S.	43-883479A 2	N/A
Bravo III	2.43	2004 - 2019	0W250000 and up	N.S.S.	43-8M0060005	N/A
Bravo III	2.20	1988 - 1995	0B664190 - 0F729999	N.L.A.(2)	43-883479A 4	43-803109T 2
Bravo III	2.20	1996 - 1999	0F730000 - 0M100000	N.L.A.(3)	43-883479A 3	43-803109T 2
Bravo III	2.20	2000 - 2004	0M100001 - 0W249999	N.S.S.	43-883479A 2	N/A
Bravo III	2.20	2004 - 2019	0W250000 and up	N.S.S.	43-8M0060005	N/A
Bravo III	2.00	1988 - 1995	0B664190 - 0F729999	N.L.A.(4)	43-883473A 4	43-803107T 2
Bravo III	2.00	1996 - 1999	0F730000 - 0M100000	N.L.A.(5)	43-883473A 3	43-803107T 2
Bravo III	2.00	2000 - 2004	0M100001 - 0W249999	N.S.S.	43-883473A 2	N/A
Bravo III	2.00	2004 - 2019	0W250000 and up	N.S.S.	43-8M0060003	N/A
Bravo III	1.81	1988 - 1995	0B664190 - 0F729999	N.L.A.(6)	43-883476A 4	43-803108T 2
Bravo III	1.81	1996 - 1999	0F730000 - 0M100000	N.L.A.(7)	43-883476A 3	43-803108T 2

MERCURY® MERCUISER® DRIVE SYSTEMS

MERCURY® MERCUISER®

Model	Gear Ratio	Year Range	Serial # Range	Drive Gear	Driven Gear/ Gear Kit	Upper Gear Repair Kit
Bravo III	1.81	2000 - 2004	0M100001 - 0W249999	N.S.S.	43-883476A 2	N/A
Bravo III	1.81	2004 - 2019	0W250000 and up	N.S.S.	43-8M0060004	N/A
Bravo III	1.65	1988 - 1995	0B664190 - 0F729999	N.L.A.(4)	43-883473A 4	43-803107T 2
Bravo III	1.65	1996 - 1999	0F730000 - 0M100000	N.L.A.(5)	43-883473A 3	43-803107T 2
Bravo III	1.65	2000 - 2004	0M100001 - 0W249999	N.S.S.	43-883473A 2	N/A
Bravo III	1.65	2004 - 2019	0W250000 and up	N.S.S.	43-8M0060003	N/A
Bravo III	1.50	1988 - 1995	0B664190 - 0F729999	N.L.A.(4)	43-883473A 4	43-803107T 2
Bravo III	1.50	1996 - 1999	0F730000 - 0M100000	N.L.A.(5)	43-883473A 3	43-803107T 2
Bravo III	1.50	2000 - 2019	0M100001 and up	N.S.S.	43-883473A 2	N/A
Bravo III	1.36	1996 - 1999	0F730000 - 0M100000	N.L.A.(7)	43-883476A 3	43-803108T 2
Bravo III	1.36	2000 - 2019	0M100001 and up	N.S.S.	43-883476A 2	N/A
Bravo III - Diesel	2.43	1996 - 1999	0F730000 - 0M100000	N.S.S.	43-883479A 3	N/A
Bravo III - Diesel	2.20	1996 - 1999	0F730000 - 0M100000	N.S.S.	43-883479A 3	N/A
Bravo III - Diesel	2.00	1996 - 1999	0F730000 - 0M100000	N.S.S.	43-883473A 3	N/A
Bravo III - Diesel	1.81	1996 - 1999	0F730000 - 0M100000	N.S.S.	43-883476A 3	N/A
Bravo III - Diesel	1.65	1996 - 1999	0F730000 - 0M100000	N.S.S.	43-883473A 3	N/A
Bravo III - Diesel	1.50	1996 - 1999	0F730000 - 0M100000	N.S.S.	43-883473A 3	N/A
Bravo III - Diesel	1.36	1996 - 1999	0F730000 - 0M100000	N.S.S.	43-883476A 3	N/A
Bravo III X	2.43	2000 - 2019	0M100001 and up	N.S.S.	43-887909A 1	N/A
Bravo III X	2.20	2000 - 2019	0M100001 and up	N.S.S.	43-887909A 1	N/A
Bravo III X	2.00	2000 - 2019	0M100001 and up	N.S.S.	43-887903A 1	N/A
Bravo III X	1.81	2000 - 2019	0M100001 and up	N.S.S.	43-887906A 1	N/A
Bravo III X	1.65	2000 - 2019	0M100001 and up	N.S.S.	43-887903A 1	N/A
Bravo III X	1.50	2000 - 2019	0M100001 and up	N.S.S.	43-887903A 1	N/A
Bravo III X	1.36	2000 - 2019	0M100001 and up	N.S.S.	43-887906A 1	N/A
Blackhawk	1.65	1994	0F186717 - 0F392505	N.L.A.(2)	43-883479A 4	N/A
Blackhawk	1.65	1994 - 2019	0F392506 and up	N.L.A.(5)	43-883473A 4	N/A
Blackhawk	1.50	1994 - 2019	0F186717 and up	N.L.A.(5)	43-883473A 4	N/A
Blackhawk	1.36	1994 - 2019	0F186717 and up	N.L.A.(6)	43-883476A 4	N/A
III	1.50	1968 - 1972	2373127 - 3002613	N.S.S.	N.L.A.	N/A
III	2.00	1968 - 1972	2373127 - 3002613	N.S.S.	N.L.A.	N/A
TR/TRS		1973 - 1993	3377316 and up	N.L.A.	43-62879T 1	N/A

(1) Some early 1.5 units with cone 89449 & cup 89410 must order an additional bearing 31-35990A 1

(2) Order gear kit 43-883479A 4

(3) Order gear kit 43-883479A 3

(4) Order gear kit 43-883473A 4

(5) Order gear kit 43-883473A 3

(6) Order gear kit 43-883476A 4

(7) Order gear kit 43-883476A 3

SEAL KITS - DRIVESHAFT HOUSING

SEAL KIT



26-32511A 1

Fits I, IA/IB/IC, MC-I, R, MR & Alpha One (1964-1990)

SEAL KIT



26-88397A 1

Driveshaft Hsg
Fits Alpha One Gen II (1991 & newer)

Not all parts listed are available for the European, C.I.S., Africa and Middle East Markets.
For more information, please contact your local Mercury, Mariner, MerCruiser or Quicksilver Office.

SEAL KIT

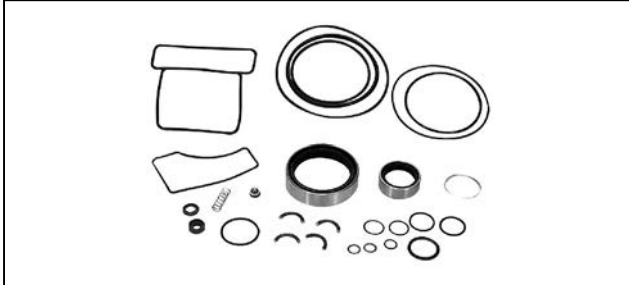

26-16709A 2

Driveshaft Hsg
Fits Bravo I, II, III, X, XR & XZ

SEAL & BEARING KITS - GEAR HOUSING

SEAL & BEARING KIT

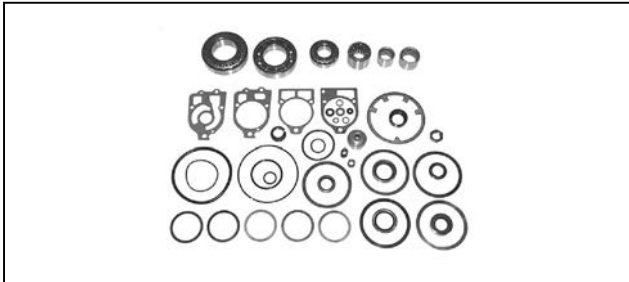

31-803068T 1

Fits R drive

SEAL & BEARING KIT

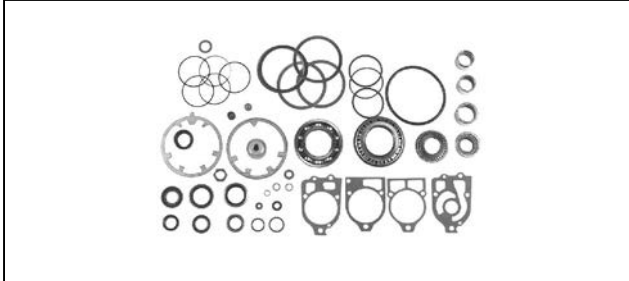

31-803090T 1

Standard Rotation (RH)
Fits MR & Alpha One

SEAL & BEARING KIT



31-803094T 1

Standard Rotation (RH)
Fits Alpha One Gen II (s/n 0D469859-0F679999)

SEAL & BEARING KIT



31-803096T 1

Standard Rotation (RH)
Fits Alpha One Gen II (s/n 0L100040 and up)

SEAL & BEARING KIT



31-803080T02

Fits Bravo I & I X

31-803082T02

Fits Bravo II & II X

31-803085T02

Fits Bravo III & III X

SEAL KITS - GEAR HOUSING

SEAL KIT



26-33144A 2

Fits IA/IB/IC & EZ Shift, MC-I, R, MR, Alpha One & SS

SEAL KIT



26-816575A 3

Fits Alpha One Gen II

SEAL KIT



26-76868A04

Gearcase
Fits Bravo I, II, III & X

SEAL KIT - PROPSHAFT



26-815565A02

Fits Bravo I XR/XZ

SEAL CHART - STERNDRIVE

Stern Drive Seal Chart

Model	Year Range	Serial # Range	Driveshaft Housing Seal Kit	J-Joint Seal	Gear Housing Seal & Bearing Kit	Gear Housing Seal Kit	Bearing Carrier O-Ring	Bearing Carrier Seal
60/80/90	1965 - 1972	1830753 - 3225967	N/A	N.L.A.	N/A	N/A	25-31986	26-90562(1)
60/80/90	1965 - 1972	1830753 - 3225967	N/A	N.L.A.	N/A	N/A	25-31986	N.L.A.(2)
I	1963	1534570 - 1684187	N/A	N.L.A.	N/A	N/A	25-29976	26-76868
IA/IB/IC & EZ Shift	1964 - 1966	1684188 - 2065186	26-32511A 1	26-823894	N/A	26-33144A 2	25-31534	26-76868
120/140	1967 - 1982	2062141 - 6225576	26-32511A 1	26-823894	N/A	26-33144A 2	25-31534	26-76868
470/485	1976 - 1982	4208730 - 6225575	26-32511A 1	26-823894	N/A	26-33144A 2	25-31534	26-76868
160/165	1967 - 1981	2065190 and up	26-32511A 1	26-823894	N/A	26-33144A 2	25-31534	26-76868
888	1971 - 1977	3106717 and up	26-32511A 1	26-823894	N/A	26-33144A 2	25-31534	26-76868
225/233	1974 - 1977	3856268 and up	26-32511A 1	26-823894	N/A	26-33144A 2	25-31534	26-76868
898/228/250/260	1977 - 1982	4782330 - 6225576	26-32511A 1	26-823894	N/A	26-33144A 2	25-31534	26-76868
R	1983	6225577 and up	26-32511A 1	26-823894	31-803068T 1	26-33144A 2	25-31534	26-76868
MR/Alpha One	1984 - 1990	6225577 - 0D469858	26-32511A 1	26-823894	31-803090T 1	26-33144A 2	25-31534	26-76868(3)
MR/Alpha One	1984 - 1990	6225577 - 0D469858	26-32511A 1	26-823894	31-803090T 1	26-33144A 2	25-31534	26-14077(1)
MR/Alpha One	1984 - 1990	6225577 - 0D469858	26-32511A 1	26-823894	31-803090T 1	26-33144A 2	25-31534	26-12224(2)
MR/Alpha One (CR)	1984 - 1990	6225577 - 0D469858	26-32511A 1	26-823894	N.L.A.	26-33144A 2	25-31534	26-14077(1)
MR/Alpha One (CR)	1984 - 1990	6225577 - 0D469858	26-32511A 1	26-823894	N.L.A.	26-33144A 2	25-31534	26-12224(2)
Alpha One SS	1986 - 1989	0A545004 and up	26-32511A 1	26-823894	N/A	26-33144A 2	25-31534	26-76868(3)
Alpha One SS	1986 - 1989	0A545004 and up	26-32511A 1	26-823894	N/A	26-33144A 2	25-31534	26-14077(1)
Alpha One SS	1986 - 1989	0A545004 and up	26-32511A 1	26-823894	N/A	26-33144A 2	25-31534	26-12224(2)
Alpha One Gen II	1991 - 1995	0D469859 - 0F679999	26-88397A 1	26-823894	31-803094T 1	26-816575A 3	25-31534	26-14077(1)
Alpha One Gen II	1991 - 1995	0D469859 - 0F679999	26-88397A 1	26-823894	31-803094T 1	26-816575A 3	25-31534	26-12224(2)
Alpha One Gen II (CR)	1991 - 1995	0D469859 - 0F679999	26-88397A 1	26-823894	N.L.A.	26-816575A 3	25-31534	26-14077(1)
Alpha One Gen II (CR)	1991 - 1995	0D469859 - 0F679999	26-88397A 1	26-823894	N.L.A.	26-816575A 3	25-31534	26-12224(2)
Alpha One Gen II	1996 - 1997	0F680000 - 0K999999	26-88397A 1	26-823894	N.L.A.	26-816575A 3	25-31534	26-14077(1)
Alpha One Gen II	1996 - 1997	0F680000 - 0K999999	26-88397A 1	26-823894	N.L.A.	26-816575A 3	25-31534	26-12224(2)
Alpha One Gen II (CR)	1996 - 2019	0F680000 and up	26-88397A 1	26-823894	N.L.A.	26-816575A 3	25-31534	26-14077(1)
Alpha One Gen II (CR)	1996 - 2019	0F680000 and up	26-88397A 1	26-823894	N.L.A.	26-816575A 3	25-31534	26-12224(2)
Alpha One Gen II	1998 - 2019	0L100040 and up	26-88397A 1	26-823894	31-803096T 1	26-816575A 3	25-31534	26-14077(1)
Alpha One Gen II	1998 - 2019	0L100040 and up	26-88397A 1	26-823894	31-803096T 1	26-816575A 3	25-31534	26-12224(2)
Bravo I	1988 - 2019	0B664190 and up	26-16709A 2	26-807006	31-803080T02	26-76868A04	25-31534	26-76868
Bravo I X	2000 - 2019	0M100001 and up	26-16709A 2	26-807006	31-803080T02	26-76868A04	25-31534	26-76868
Bravo I XR/XZ	2000 - 2019	0M100001 and up	26-16709A 2	26-807006	N/A	26-815565A02	25-31534	26-815565
Bravo II	1988 - 2019	0B664190 and up	26-16709A 2	26-807006	31-803082T02	26-76868A04	25-34821	26-814242(2)
Bravo II	1988 - 2019	0B664190 and up	26-16709A 2	26-807006	31-803082T02	26-76868A04	25-34821	26-821092(1)
Bravo II X	2000 - 2019	0M100001 and up	26-16709A 2	26-807006	31-803082T02	26-76868A04	25-34821	26-814242(2)

Not all parts listed are available for the European, C.I.S., Africa and Middle East Markets.
For more information, please contact your local Mercury, Mariner, MerCruiser or Quicksilver Office.

MERCURY® MERCRUISER® DRIVE SYSTEMS

Model	Year Range	Serial # Range	Driveshaft Housing Seal Kit	J-Joint Seal	Gear Housing Seal & Bearing Kit	Gear Housing Seal Kit	Bearing Carrier O-Ring	Bearing Carrier Seal
Bravo II X	2000 - 2019	0M100001 and up	26-16709A 2	26-807006	31-803082T02	26-76868A04	25-34821	26-821092(1)
Bravo III	1988 - 2019	0B664190 and up	26-16709A 2	26-807006	31-803085T02	26-76868A04	25-805331	26-861694
Bravo III X	2000 - 2019	0M100001 and up	26-16709A 2	26-807006	31-803085T02	26-76868A04	25-805331	26-861694
Blackhawk	1994 - 1995	0F186717 and up	26-16709A 2	26-807006	N/A	N/A	25-69201	26-861694
II	1962 - 1969	1474909 - 2671321	N/A	N/A	N/A	N/A	25-31534	N.L.A.
III	1968 - 1972	2373127 - 3002613	N/A	N/A	N/A	N/A	N.L.A.	26-19473
215E/H	1970 - 1972	2909035 - 2915034	N/A	N/A	N/A	N/A	25-34821	26-821092
TR	1973 - 1993	3377316 and up	N/A	N/A	N/A	N/A	25-34821	26-821092
TRS	1973 - 1993	3377316 and up	N/A	N/A	N/A	N/A	25-31534	26-76868

(1) Inner

(2) Outer

(3) W/o fishline cutter seal

GEAR REPAIR KITS - GEAR HOUSING

GEAR REPAIR KIT



43-803079T 1

Fits R drive

GEAR REPAIR KIT



43-803091T 1

Standard Rotation (RH)

Fits MR & Alpha One

GEAR REPAIR KIT



43-803069T 1

Standard Rotation (RH)

Fits Alpha One Gen II (except 2.40 ratio) (s/n 0D469859-0F679999)

GEAR REPAIR KIT



43-803071T 1

Standard Rotation (RH)

Fits Alpha One Gen II (except 2.40 ratio) (s/n 0F680000-0K999999)

GEAR REPAIR KIT



43-803073T 1

Standard Rotation (RH)

Fits Alpha One Gen II (except 2.00 & 2.40 ratio) (s/n 0L100040 and up)

43-803074T 1

Standard Rotation (RH)

Fits Alpha One Gen II (2.00 & 2.40 ratio) (s/n 0L100040 and up)

GEAR REPAIR KIT



43-803081T02

Fits Bravo I & I X

GEAR REPAIR KIT

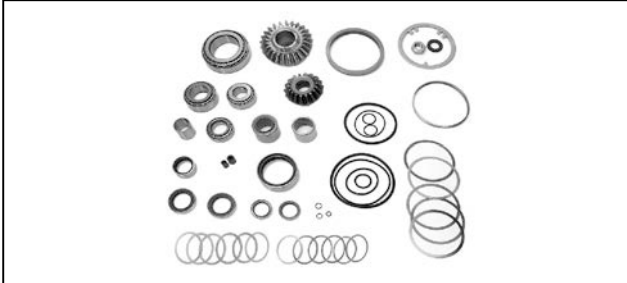

43-803083T02

Fits Bravo II & II X (1.81, 2.00 & 2.20 ratio)

GEAR REPAIR KIT



43-803087T02

Fits Bravo III & III X (1.65 ratio)

43-803088T02

Fits Bravo III & III X (1.81, 2.00 & 2.20 ratio)

43-803089T02

Fits Bravo III & III X (2.43 ratio)

GEARS - GEAR HOUSING

FORWARD GEAR SET



43-96084A 4

17-28 teeth
Fits MC-I drive

FORWARD GEAR SET

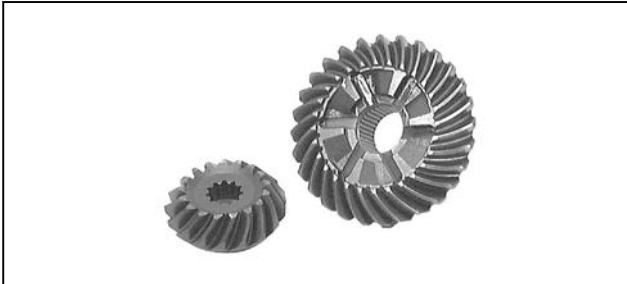

43-96084A 7

17-28 teeth
Fits R drive

FORWARD GEAR SET



43-878087A 4

13-21 teeth
Fits MR/ Alpha One/ Gen II

FORWARD GEAR SET



43-878087A 2

13-21 teeth, Standard Rotation (RH)
Fits Alpha One Gen II (except 2.00 & 2.40 ratio) (s/n 0F680000 and above)

FORWARD GEAR SET



43-878617A 2

14-28 teeth, Standard Rotation (RH)
Fits Alpha One Gen II (2.00 & 2.40 ratio) (s/n 0L100040 and above)

FORWARD GEAR SET



43-828289A 1

13-21 teeth, Counter Rotation
Fits Alpha One Gen II (C/R) (except 2.00 ratio) (s/n 0F680000 and above)

FORWARD GEAR SET



43-855651A 1

14-28 teeth, Counter Rotation (LH)
Fits Alpha One Gen II (2.00 ratio) (s/n 0L100040 and above)

FORWARD GEAR SET



43-14063A 1

15-19 teeth
Fits Bravo I & I X

GEAR SET



43-818928A 2

15-19 teeth
Fits Bravo I XR & XZ (1.36 & 1.50 ratio)

FORWARD GEAR



43-827303

25 teeth
Fits Bravo II & II X (1.50 & 1.65 ratio)

FORWARD GEAR SET



43-41657T

27 teeth
Fits Bravo II & II X (1.81, 2.00 & 2.20 ratio)

FORWARD GEAR SET



43-805448A 1

15-19-19 teeth
Fits Bravo III & III X (1.36 & 1.50 ratio)

FORWARD GEAR SET



43-824517A 1

18-25-25 teeth
Fits Bravo III & III X/XR (1.65 ratio)

FORWARD GEAR SET



43-822535A 1

16-27-27 teeth
Fits Bravo III, III X (1.81, 2.00 & 2.20 ratio) & III XR (2.00 ratio)

MERCURY® MERCRUISER®

FORWARD GEAR SET



43-841910A01

17-26-26 teeth
Fits Bravo III XR (1.81 ratio)

FORWARD GEAR SET



43-828336A 1

13-24-24 teeth
Fits Bravo III & III X (2.43 ratio)

PINION GEAR



43-41656T

16 teeth
Fits Bravo II & II X (1.81, 2.00 & 2.20 ratio)

PINION GEAR



43-827304T

18 teeth
Fits Bravo II (1.50 & 1.65 ratio)

REVERSE GEAR



43-31887

REVERSE GEAR

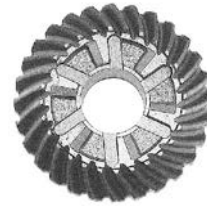

43-92320T

28 teeth
Fits R drive

REVERSE GEAR



43-828073A 1

21 teeth
Fits Alpha I Gen II

REVERSE GEAR



43-853593A 1

28 teeth (2.00/2.40 ratio)
Fits Alpha I Gen II

MERCURY® MERCUISER®

MERCURY® MERCURISER® DRIVE SYSTEMS

REVERSE GEAR



43-828290T 2

21 teeth
Fits Alpha One Gen II (CR)(s/n 0F680000 & up)

REVERSE GEAR



43-824109A 1

28 teeth
Fits MR, Alpha One & Gen II sterndrives

REVERSE GEAR



43-855652T 1

28 teeth
Fits Alpha I Gen II (CR) (2.00 ratio)

MERCURY® MERCURISER®

GEAR CHART - GEAR HOUSING

Gear Case Gears

Model	Gear Ratio	Year Range	Serial # Range	Gear Housing Repair Kit	Forward Gear	Pinion Gear	Reverse Gear
I	2.00	1963	1534570 - 1536617	N/A	N.L.A.	N.L.A.	43-31887
I	2.00	1963	1536618 - 1684187	N/A	N.L.A.	N.L.A.	N.L.A.
IA	1.84	1964 - 1966	1684188 - 1776348	N/A	N.L.A.	N.L.A.	N.L.A.
IB	2.01	1964 - 1966	1684633 - 1775192	N/A	N.L.A.	N.L.A.	N.L.A.
IC	1.68	1964 - 1966	1685240 - 1777798	N/A	N.L.A.	N.L.A.	N.L.A.
IA EZ Shift	1.84	1964 - 1966	1776449 - 2065189	N/A	N.L.A.	N.L.A.	N.L.A.
IB EZ Shift	2.01	1964 - 1966	1775193 - 2065189	N/A	N.L.A.	N.L.A.	N.L.A.
IC EZ Shift	1.68	1964 - 1966	1777799 - 2065189	N/A	N.L.A.	N.L.A.	N.L.A.
120/140	1.98	1967 - 1972	2062141 - 3443920	N/A	N.L.A.	N.L.A.	N.L.A.
120/140	1.98	1972 - 1977	3469428 - 4893634	N/A	43-96084A 4	N/A	N.L.A.
120/140	1.98	1978 - 1982	4893635 - 6225576	N/A	43-96084A 4	N/A	N/A
470/485	1.84	1976 - 1977	4208730 - 4893934	N/A	43-96084A 4	N/A	N.L.A.
470/485	1.84	1978 - 1982	4893835 - 6225575	N/A	43-96084A 4	N/A	N/A
160	1.68	1967 - 1969	2065190 - 2763441	N/A	N.L.A.	N.L.A.	N.L.A.
165	1.65	1970 - 1977	2763442 - 4890459	N/A	43-96084A 4	N/A	N.L.A.
165	1.65	1978 - 1981	4890460 and up	N/A	43-96084A 4	N/A	N/A
888	1.50	1971 - 1977	3106717 and up	N/A	43-96084A 4	N/A	N.L.A.
225/233	1.50/1.32	1974 - 1977	3856268 and up	N/A	43-96084A 4	N/A	N.L.A.
898/228	1.65/1.50	1977 - 1982	4782330 - 6225576	N/A	43-96084A 4	N/A	N/A
250/260	1.50/1.32	1977 - 1982	4791300 - 6225576	N/A	43-96084A 4	N/A	N/A
R	ALL	1983	6225577 - 6810537	43-803079T 1	43-96084A 7	N/A	43-92320T

MERCURY® MERCUISER® DRIVE SYSTEMS

Model	Gear Ratio	Year Range	Serial # Range	Gear Housing Repair Kit	Forward Gear	Pinion Gear	Reverse Gear
MR/Alpha One	ALL	1984 - 1990	6810538 - 0D469858	43-803091T 1	43-878087A 4	N/A	43-824109A 1
MR/Alpha One (CR)	ALL	1984 - 1990	6810538 - 0D469858	N.L.A.	N.L.A.	N/A	N.L.A.
Alpha One SS	ALL	1986 - 1989	0A545004 and up	N/A	43-878087A 4	N/A	43-824109A 1
Alpha One Gen II	1.98/1.84/1.65/1.50	1991 - 1995	0D469859 - 0F679999	43-803069T 1	43-878087A 4	N/A	43-824109A 1
Alpha One Gen II	2.40	1991 - 1995	0D469859 - 0F679999	N.L.A.	N.L.A.	N/A	N/A
Alpha One Gen II (CR)	ALL	1991 - 1995	0D469859 - 0F679999	N.L.A.	N.L.A.	N/A	N.L.A.
Alpha One Gen II	1.94/1.81/1.62/1.47	1996 - 1997	0F680000 - 0K999999	43-803071T 1	43-878087A 2	N/A	43-828073A 1
Alpha One Gen II	2.40	1996 - 1997	0F680000 - 0K999999	N.L.A.	N.L.A.	N/A	N/A
Alpha One Gen II (CR)	1.94/1.81/1.62/1.47	1996 - 1997	0F680000 - 0K999999	N.L.A.	43-828289A 1	N/A	43-828290T 2
Alpha One Gen II	1.94/1.81/1.62/1.47	1998 - 2019	0L100040 and up	43-803073T 1	43-878087A 2	N/A	43-828073A 1
Alpha One Gen II	2.00/2.40	1998 - 2019	0L100040 and up	43-803074T 1	43-878617A 2	N/A	43-853593A 1
Alpha One Gen II (CR)	1.94/1.81/1.62/1.47	1998 - 2019	0L100040 and up	N.L.A.	43-828289A 1	N/A	43-828290T 2
Alpha One Gen II (CR)	2.00	1998 - 2019	0L100040 and up	N/A	43-855651A 1	N/A	43-855652T 1
Vazer	2.77/2.58	2007 - 2009	0W995000 and up	N/A	N.L.A.	N/A	N.L.A.
Bravo I	ALL	1988 - 2019	0B664190 and up	43-803081T02	43-14063A 1	N/A	N/A
Bravo I X	ALL	2000 - 2019	0M100001 and up	43-803081T02	43-14063A 1	N/A	N/A
Bravo I XR/XZ	1.50/1.36	2000 - 2019	0M100001 and up	N/A	43-818928A 2	N/A	N/A
Bravo II & II X	1.81/2.00/2.20	1988 - 2019	0B664190 and up	43-803083T02	43-41657T	43-41656T	N/A
Bravo II & II X	1.50/1.65	1988 - 2019	0B664190 and up	N.L.A.	43-827303	43-827304T	N/A
Bravo III & III X	1.36/1.50	1988 - 2019	0B664190 and up	N.L.A.	43-805448A 1	N/A	N/A
Bravo III & III X	1.65	1988 - 2019	0B664190 and up	43-803087T02	43-824517A 1	N/A	N/A
Bravo III & III X	1.81/2.00/2.20	1988 - 2019	0B664190 and up	43-803088T02	43-822535A 1	N/A	N/A
Bravo III & III X	2.43	1988 - 2019	0B664190 and up	43-803089T02	43-828336A 1	N/A	N/A
Bravo III XR	1.65	2004 - 2019	0W240000 and up	43-803087T02	43-824517A 1	N/A	N/A
Bravo III XR	1.81	2004 - 2019	0W240000 and up	N/A	43-841910A01	N/A	N/A
Bravo III XR	2.00	2004 - 2019	0W240000 and up	43-803088T02	43-822535A 1	N/A	N/A
Blackhawk	1.36/1.50	1994 - 2019	0F186717 and up	N/A	43-805448A 1	N/A	N/A
Blackhawk	1.65	1994	0F186717 - 0F392505	N/A	43-805448A 1	N/A	N/A
Blackhawk	1.65	1994 - 2019	0F392506 and up	N/A	43-824517A 1	N/A	N/A
Blackhawk	1.81	1994 - 2019	0F186717 and up	N/A	43-822535A 1	N/A	N/A
TR	2.00	1973 - 1993	3377316 and up	N/A	N.L.A.	N.L.A.	N/A
TRS	1.33	1973 - 1993	3377316 and up	N/A	N.L.A.	N.L.A.	N/A
TRS	1.50	1973 - 1993	3377316 and up	N/A	N.L.A.	N.L.A.	N/A

MERCURY® MERCUISER®

MERCURY® MERCUISER® POWER TRIM

POWER TRIM PUMPS AND COMPONENTS

TRIM PUMP ASSEMBLY



93247A 7

Replacement pump for older Prestolite high pressure/low flow system

865380A25

Oildyne low pressure/high flow

TRIM PUMP ASSEMBLY



865380A13

Oildyne low pressure/high flow with top mount reservoir

P/T PUMP MOTOR



891736T

For Oildyne P/T pump w/metal or plastic reservoir
Fits 1991 & newer Alpha One Gen II drives, also fits 1988 & newer Bravo drives.

P/T PUMP MOTOR



17649A02

For Oildyne P/T pump w/plastic reservoir

P/T PUMP MOTOR ARMATURE



392- 2943

For Prestolite P/T pump w/metal reservoir

BRUSH SET

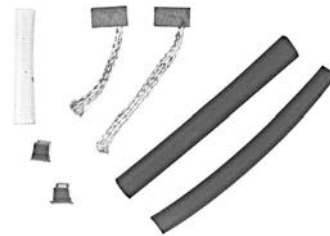

392- 8989

For Prestolite P/T Motor

RESERVOIR

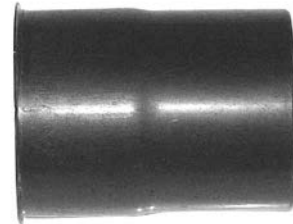

41219T

For Oildyne w/metal reservoir

RESERVOIR KIT



883166A 2

Top mount reservoir
For Oildyne P/T pump with plastic reservoir

MERCURY® MERCUISER®

RESERVOIR UPDATE KIT



883169A 1

Top mount reservoir
For Oildyne P/T pump w/plastic reservoir

OVERHAUL REPAIR KIT



18545A 1

For Oildyne P/T pump

SOLENOID



25661T 1

Used for power trim and starting systems
Fits various O/B & MCM applications

SOLENOID



89- 96158T

Stepped mounting plate
Fits Outboard Starters & MerCruiser Starters and Pwr Trim.

SOLENOID



89-853654A 1

Fits Outboard 2 Cyl. & In-Line 6 & MCM applications

POWER TRIM SENDER



805320A03

Includes trim limit switch also.
Fits MC-I, R, MR, Alpha One, Gen II, Bravo drives.

P/T SENDER ROTOR KIT



805134A 4

Replacement rotor

TRIM CYLINDER REPAIR KITS

TRIM CYLINDER OVERHAUL KIT



45522A 3

For MC-I drive

TRIM CYLINDER OVERHAUL KIT



87399A 2

For R, MR, Alpha One & Bravo

TRIM CYLINDER OVERHAUL KIT



87399A 3

For Alpha One Gen II

TRIM CYLINDER OVERHAUL KIT



86611A 1

For TR/TRS

TRIM CYLINDER O-RING KITS

TRIM CYLINDER O-RING KIT



25- 60342A 2

For MC-I drive trim cylinder having internal trim lines

TRIM CYLINDER O-RING KIT

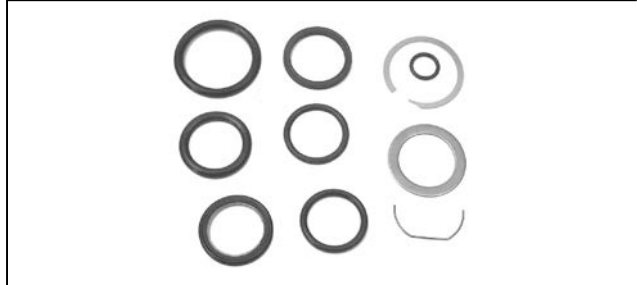

25- 60342A 3

For MC-I drive trim cylinder having external trim lines

TRIM CYLINDER O-RING KIT

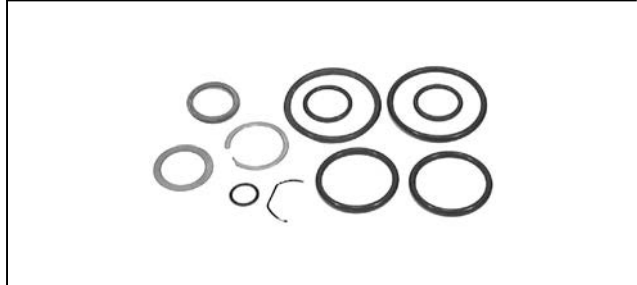

25- 87400A 2

For R, MR, Alpha One, Gen II & Bravo

TRIM CYLINDER O-RING KIT

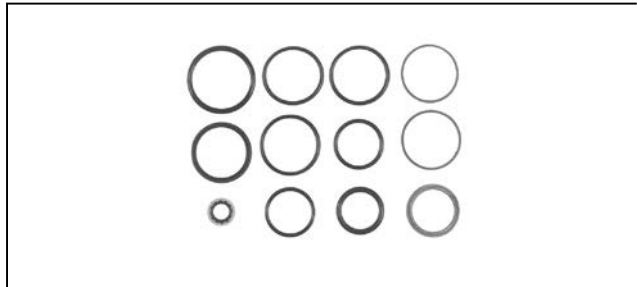

25- 47389A 2

For TR/TRS, 215H & II drive

TRIM CYLINDER O-RING KIT

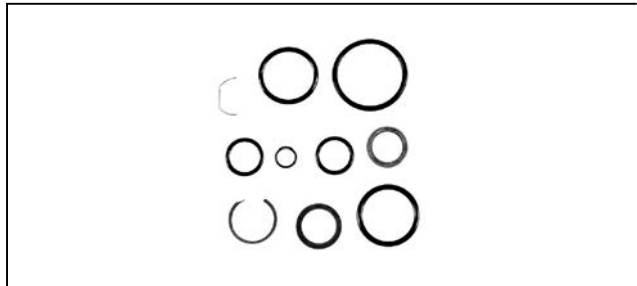

25- 79871A 1

For TR/TRS

MERCURY® MERCRUISER®

TRIM CYLINDER CHART

Trim Cylinders

Model	Year Range	Serial # Range	Replacement Trim Cylinder - Port	Replacement Trim Cylinder - Starboard	Original Trim Cylinder Overhaul Kit	Original Trim Cylinder Outer Housing - Port	Original Trim Cylinder Outer Housing - Stbd.	Original Trim Cylinder Seal Kit
120/140	1967 - 1969	2062141 - 2791956	N.L.A.	N.L.A.	N/A	N/A	N/A	N/A
120/140	1970 - 1977	2791957 - 4893634	N.L.A.	N.L.A.	45522A 3	77442A 1	77442A 1	25- 60342A 2
120/140	1978 - 1982	4893635 - 6225576	N.L.A.(13)	N.L.A.(13)	45522A 3	77442A 1	77442A 1	25- 60342A 2
120/140	1978 - 1982	4893635 - 6225576	87173A10(14)	87173A10(14)	N.L.A.	N.L.A.	N.L.A.	25- 60342A 3
470/485	1976 - 1977	4208730 - 4893934	N.L.A.	N.L.A.	45522A 3	77442A 1	77442A 1	25- 60342A 2
470/485	1978 - 1982	4893835 - 6225575	N.L.A.(13)	N.L.A.(13)	45522A 3	77442A 1	77442A 1	25- 60342A 2
470/485	1978 - 1982	4893835 - 6225575	87173A10(14)	87173A10(14)	N.L.A.	N.L.A.	N.L.A.	25- 60342A 3
160	1967 - 1969	2065190 - 2763441	N.L.A.	N.L.A.	N/A	N/A	N/A	N/A
165	1970 - 1977	2763442 - 4890459	N.L.A.	N.L.A.	45522A 3	77442A 1	77442A 1	25- 60342A 2
165	1978 - 1981	4890460 - 4890459	N.L.A.(13)	N.L.A.(13)	45522A 3	77442A 1	77442A 1	25- 60342A 2
165	1978 - 1981	4890460 - 4890459	87173A10(14)	87173A10(14)	N.L.A.	N.L.A.	N.L.A.	25- 60342A 3
888	1971 - 1977	3106717 and up	N.L.A.	N.L.A.	45522A 3	77442A 1	77442A 1	25- 60342A 2
225/233	1974 - 1977	3856268 and up	N.L.A.	N.L.A.	45522A 3	77442A 1	77442A 1	25- 60342A 2
898/228	1977	4782330 - 4898729	N.L.A.	N.L.A.	45522A 3	77442A 1	77442A 1	25- 60342A 2
898/228	1978 - 1982	4898730 - 6225576	N.L.A.(13)	N.L.A.(13)	45522A 3	77442A 1	77442A 1	25- 60342A 2
898/228	1978 - 1982	4898730 - 6225576	87173A10(14)	87173A10(14)	N.L.A.	N.L.A.	N.L.A.	25- 60342A 3
250	1977	4791300 - 4898729	N.L.A.	N.L.A.	45522A 3	77442A 1	77442A 1	25- 60342A 2
260	1978 - 1982	4898730 - 6225576	N.L.A.(13)	N.L.A.(13)	45522A 3	77442A 1	77442A 1	25- 60342A 2
260	1978 - 1982	4898730 - 6225576	87173A10(14)	87173A10(14)	N.L.A.	N.L.A.	N.L.A.	25- 60342A 3
R/MR/Alpha One	1983 - 1990	6225577 - 0D469858	98703A 3(11)	98704A 3(11)	87399A 2	N.L.A.(5)	N.L.A.(7)	25- 87400A 2
R/MR/Alpha One	1983 - 1990	6225577 - 0D469858	98703A 3(11)	98704A 3(11)	87399A 2	98703A10(6)	N.L.A.(8)	25- 87400A 2
R/MR/Alpha One	1983 - 1990	6225577 - 0D469858	8M0118960(12)	8M0118961(12)	87399A 2	N.L.A.(4)	N.L.A.(3)	25- 87400A 2
Alpha One SS	1986 - 1989	0A545004 and up	98703A 3(11)	98704A 3(11)	87399A 2	N.L.A.(5)	N.L.A.(7)	25- 87400A 2
Alpha One SS	1986 - 1989	0A545004 and up	98703A 3(11)	98704A 3(11)	87399A 2	98703A10(6)	N.L.A.(8)	25- 87400A 2
Alpha One SS	1986 - 1989	0A545004 and up	8M0118960(12)	8M0118961(12)	87399A 2	N.L.A.(4)	N.L.A.(3)	25- 87400A 2
Alpha One Gen II	1991 - 2019	0D469859 and up	8M0118958	8M0118959	87399A 3	N.L.A.	N.L.A.	25- 87400A 2
Vazer	2007 - 2009	0W995000 and up	N.L.A.	N.L.A.	N/A	N/A	N/A	N/A
Bravo	1988 - 2019	0B664190 and up	8M0132609	8M0132610	87399A 2	N.L.A.	N.L.A.	25- 87400A 2
Bravo SeaCore	2007 - 2019	0W900000 and up	8M0128692	8M0128693	87399A 2	N/A	N/A	25- 87400A 2
Blackhawk	1994 - 1995	0F186717 and up	8M0132609	8M0132610	87399A 2	N.L.A.	N.L.A.	25- 87400A 2
II (1.78)	1968 - 1969	2398798 - 2671321	N.L.A.	N.L.A.	N/A	N/A	N/A	N/A
III	1968 - 1972	2373127 - 3002613	N.L.A.	N.L.A.	N/A	N/A	N/A	N/A
215H	1970	2782203 - 2909034	N.L.A.	N.L.A.	N/A	N/A	N/A	N/A
215E	1970 - 1972	2909035 - 2915034	N.L.A.	N.L.A.	N/A	N/A	N/A	N/A
TR/TRS	1973 - 1993	3377316 and up	N.L.A.(10)	N.L.A.(10)	N/A(10)	N.L.A.(2)	N.L.A.(2)	25- 47389A 2(10)

MERCURY® MERCURISER®

MERCURY® MERCURISER® POWER TRIM

Model	Year Range	Serial # Range	Replacement Trim Cylinder - Port	Replacement Trim Cylinder - Starboard	Original Trim Cylinder Overhaul Kit	Original Trim Cylinder Outer Housing - Port	Original Trim Cylinder Outer Housing - Stbd.	Original Trim Cylinder Seal Kit
TR/TRS	1973 - 1993	3377316 and up	N.L.A.(10)	N.L.A.(10)	N/A(10)	N.L.A.(1)	N.L.A.(1)	25- 47389A 2(10)
TR/TRS	1973 - 1993	3377316 and up	N.L.A.(9)	87412A 3(9)	86611A 1(9)	87411A 6(9)	N.L.A.(9)	25- 79871A 1(9)

- (1) 11-3/8 inch long tubes- internal cylinder lines
- (2) 13-3/4 inch long tubes- internal cylinder lines
- (3) Casting# 14034 1
- (4) Casting# 14035 1
- (5) Casting# 98703
- (6) Casting# 98703 1
- (7) Casting# 98704
- (8) Casting# 98704 1
- (9) External trim lines
- (10) Internal trim lines
- (11) Use with 15-9/16 inch long trim cylinder tube
- (12) Use with 16-3/16 inch long trim cylinder tube
- (13) Trim cylinder with internal trim lines
- (14) Trim cylinders using external trim lines

MERCURY® MERCURISER®

TRIM CYLINDER ANCHOR PINS & KITS

FRONT ANCHOR PIN KIT



17- 14873A 1

11.87 in. OAL, .625 in. O.D., 7/16-20 threads
Fits R, MR & Alpha One

REAR ANCHOR PIN KIT

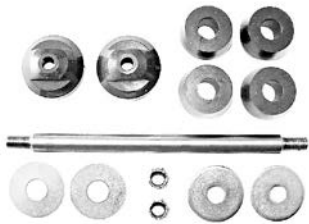

17- 14872A 1

9.18 in. OAL, .625 in. O.D., 7/16-20 threads
Fits R, MR & Alpha One

FRONT AND REAR ANCHOR PIN KIT



8M0065070

Fits Alpha One Gen II

REAR ANCHOR PIN KIT



17- 44166T 1

Fits Bravo I, II, III, X, XR & XZ

REAR ANCHOR PIN



17- 45738

7.75 in. OAL, .625 in O.D., 3/8-24 threads
Fits MC-I drive

FRONT & REAR ANCHOR PIN

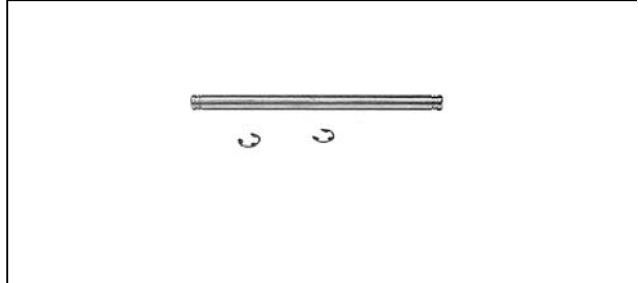

17- 815953A01

10.73 in. OAL, .625 in. O.D.
Fits Alpha One Gen II

FRONT ANCHOR PIN



17- 14873

11.87 in OAL, .625 in., 7/16-20 threads
Note: If using on a 1986 & older R, MR or Alpha One with 3/8-24 threaded anchor pin, order complete kit 17-14873A1
Fits 1986-1990 Alpha One

FRONT ANCHOR PIN



17- 44167A 1

11.87 in. OAL, .750 in. O.D., 7/16-20 threads
Fits Bravo I, II, III, X, XR & XZ

REAR ANCHOR PIN



17- 45738

7.75 in. OAL, .625 in O.D., 3/8-24 threads
Fits MC-I drive

REAR ANCHOR PIN



17- 44166

9.18 in. OAL, .750 in. O.D., 7/16-20 threads
Fits Bravo I, II, III, X, XR & XZ

TRIM CYLINDER ANCHOR PIN CHART

Trim Cylinder Hardware

Model	Year Range	Serial # Range	Anchor Pin - Front	Anchor Pin - Rear	Front Anchor Pin Kit	Rear Anchor Pin Kit	Trim Cylinder Bushings
120/140	1970 - 1982	2791957 - 6225576	N.L.A.	17- 45738	N/A	N/A	23- 89574
470/485	1978 - 1977	4208730 - 6225575	N.L.A.	17- 45738	N/A	N/A	23- 89574
165	1970 - 1981	2763442 and up	N.L.A.	17- 45738	N/A	N/A	23- 89574
888/225/233	1971 - 1977	3106717 and up	N.L.A.	17- 45738	N/A	N/A	23- 89574
898/228/250/260	1977 - 1982	4782330 - 6225576	N.L.A.	17- 45738	N/A	N/A	23- 89574
R/MR/Alpha One	1983 - 1990	6225577 - 0D469858	17- 14873	N.L.A.	17- 14873A 1	17- 14872A 1	23- 99291T
Alpha One Gen II	1991 - 2019	0D469859 and up	17- 815953A01	17- 815953A01	8M0065070	8M0065070	23- 815950 1

Not all parts listed are available for the European, C.I.S., Africa and Middle East Markets.
For more information, please contact your local Mercury, Mariner, MerCruiser or Quicksilver Office.

MERCURY® MERCRUISER® POWER TRIM

Model	Year Range	Serial # Range	Anchor Pin - Front	Anchor Pin - Rear	Front Anchor Pin Kit	Rear Anchor Pin Kit	Trim Cylinder Bushings
Bravo I/II/III	1988 - 2019	0B664190 and up	17- 44167A 1	17- 44166	N/A	17- 44166T 1	23-807073
Blackhawk	1994 - 1995	0F186717 and up	N.L.A.	N.L.A.	N/A	N/A	23-807073
II (1.78)	1968 - 1969	2398798 - 2671321	N.L.A.	N/A	N/A	N.L.A.	23- 90203
III	1968 - 1972	2373127 - 3002613	N/A	N/A	N.L.A.	N.L.A.	23- 90203
215E/H	1970 - 1972	2782203 - 2915034	N/A	N/A	N.L.A.	N.L.A.	23- 90203
TR/TRS	1973 - 1993	3377316 and up	N/A	N/A	N.L.A.	N.L.A.	23- 90203

POWER TRIM CYLINDER HOSES

POWER TRIM HOSE



32- 45703

Trim cylinder to connector block
Port - down pressure
Fits 120, 140 & 160 drives

POWER TRIM HOSE



32- 45974

Trim cylinder to connector block
Port - up pressure
Fits 120, 140 & 160 drives

POWER TRIM HOSE



32- 69871

Trim cylinder to connector block
Starboard - down pressure
Fits 120, 140 & 160 drives

POWER TRIM HOSE



32- 45973

Trim cylinder to connector block
Starboard - up pressure

POWER TRIM HOSE



32- 86036Q

A UV radiation resistant stainless steel braided power trim hose.
Port & starboard - up and down pressures.
Fits MC-I drive (s/n 6225576 and below), and MC II, III, 215 E/H, TR and TRS drives.
Quicksilver Branded, Peg Display Product Point of Sale Packaged.

POWER TRIM HOSE

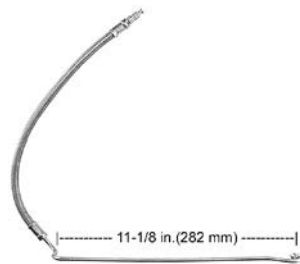

32- 87234

Trim cylinder to connector block, use w/ cylinders requiring external trim lines
Port - down pressure
Fits MC-I drive (s/n 6225576 and below)

MERCURY® MERCRUISER®

POWER TRIM HOSE

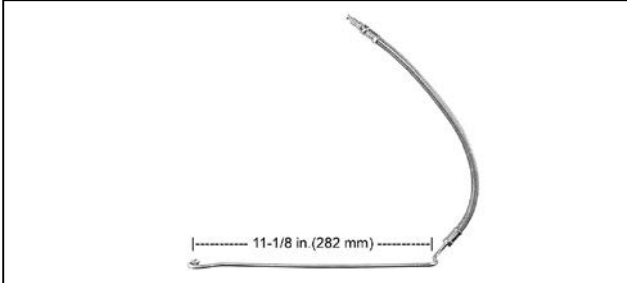

32- 87235

Trim cylinder to connector block, use w/ cylinders requiring external trim lines
Starboard - down pressure
Fits MC-I drive (s/n 6225576 and below)

POWER TRIM HOSE

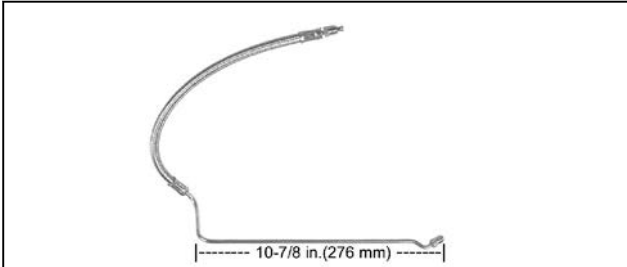

32- 864588

Trim cylinder to connector block
Port - down pressure
Fits R, MR, Alpha One & Bravo I, II, III, X, XR & XZ

POWER TRIM HOSE

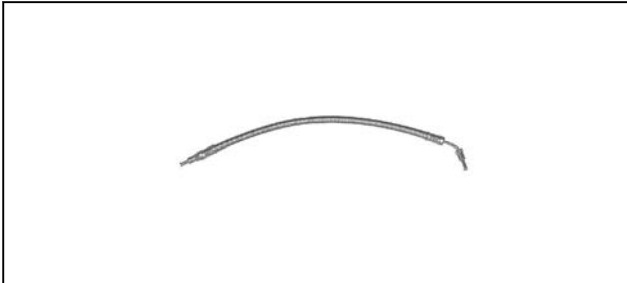

32- 99904Q

Trim cylinder to connector block
Port & starboard - up pressure
Fits R, MR, Alpha One, Gen II & Bravo I, II, III, X, XR & XZ
Quicksilver Branded, Peg Display Product Point of Sale Packaged.

POWER TRIM HOSE

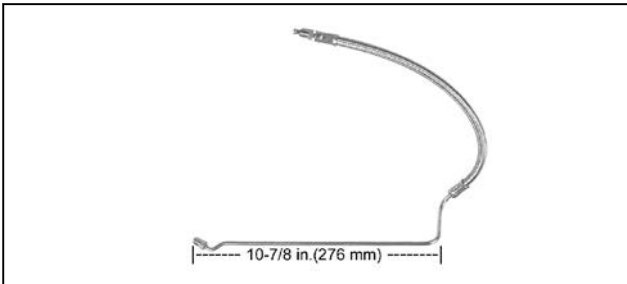

32- 864589

Trim cylinder to connector block
Starboard - down pressure
Fits R, MR, Alpha One & Bravo I, II, III, X, XR & XZ

POWER TRIM HOSE

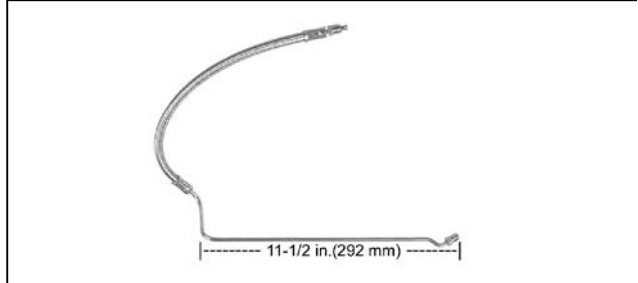

32- 864959

Trim cylinder to connector block
Port - down pressure
Fits R, MR, Alpha One & Gen II

POWER TRIM HOSE

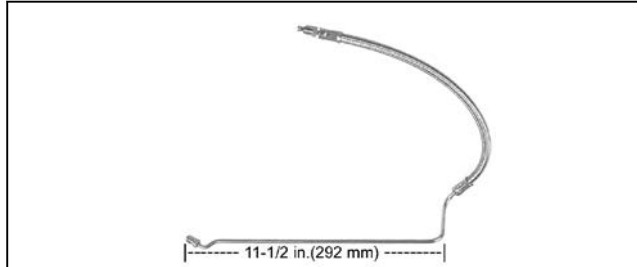

32- 864960

Trim cylinder to connector block
Starboard - down pressure
Fits R, MR, Alpha One & Gen II

POWER TRIM HOSE

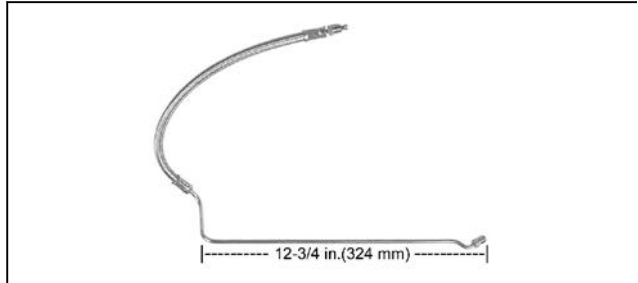

32- 87558

Trim cylinder to connector block, use w/ cylinders requiring external trim lines
Port - down pressure
Fits TR & TRS

POWER TRIM HOSE

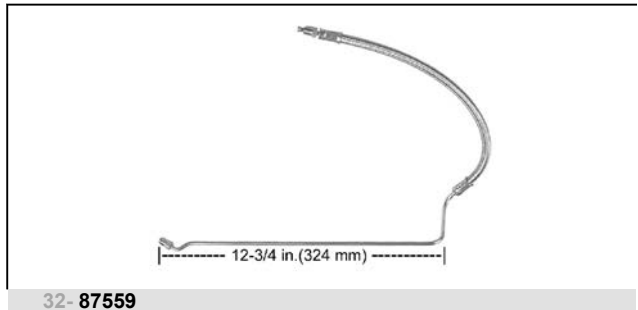

32- 87559

Trim cylinder to connector block, use w/ cylinders requiring external trim lines
Starboard - down pressure
Fits TR & TRS

TABLE OF CONTENTS

Evinrude®/Johnson® 248

Yamaha 250

Volvo 251

OMC 252

EVINRUDE®/JOHNSON®

IGNITION COIL



802371A 1

Fits OMC outboards
 Outboard Marine Corp. P/N: 582995
 584477

FUEL LINE CONNECTOR



22-802196Q

For Johnson & Evinrude Outboards - 5/16 (7.9mm)"Tank End/Engine End" (SMALL Inlet) fuel line fitting. Adapts to 802182A 1 fuel tank connector.
 OMC # 176745
 Outboard Marine Corp. P/N: 176745
 To fit original equipment OMC fuel tanks. For 6hp-115hp.

Priced individually, sold @ multiples of 2
 Quicksilver Branded, Clamshell Package Point of Sale Packaged.

FLOAT BOWL GASKET



879012

.062 Viton Material
 Outboard Marine Corp. P/N: 338880

FLOAT BOWL GASKET



878823A 1

Viton
 Outboard Marine Corp. P/N: 338813

CARBURETOR NOZZLE GASKET



879014

.062 Viton Material
 Outboard Marine Corp. P/N: 338881
 343512
 336405

Priced individually, sold @ multiples of 5

NEEDLE AND SEAT



802119A 1

Viton Tip
 Outboard Marine Corp. P/N: 379313
 396522

COMPETITOR PARTS

CARBURETOR KIT



879054A 1

Viton Gasket Material
 20-75 Hp 1976-2001
 Outboard Marine Corp. P/N: 396701
 Quicksilver Branded

CARBURETOR KIT

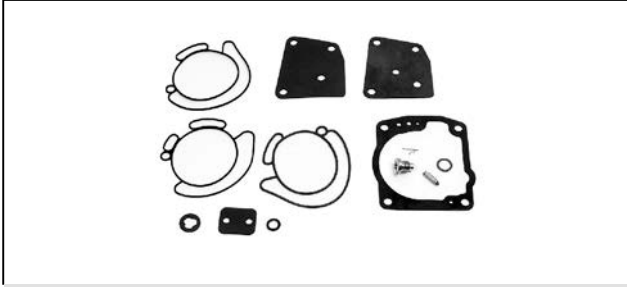

878952A 2

Viton Gasket Material
 V4 & V6 60 Degree loop 1991-2001
 Outboard Marine Corp. P/N: 435442
 V-4, V-6 60 Deg. Eagle 438996
 V-4, V-6 60 Deg. Eagle 1991- thru

CARBURETOR KIT



879055A01

Viton Gasket Material
 V4 Cross 85-140 Hp 1969-1995
 V6 Cross 150-235 Hp 1976-1991
 Outboard Marine Corp. P/N: 439076

IMPELLER



802125

88 - 235 Hp V4 & V6 1979 - 2002
 Outboard Marine Corp. P/N: 395864
 397131
 435821
 5001594
 5001595

IMPELLER



802332

9.9, 15 Hp 1974 - 2002
 Outboard Marine Corp. P/N: 386084

IMPELLER



802115

20 - 35 Hp 1979 - 2002
 Outboard Marine Corp. P/N: 395289

YAMAHA

IMPELLER



879126

Fits Yamaha 115-250 HP

Yamaha Motor Corp. P/N:

6E5-44352-00-00
115-250 Hp

COMPETITOR PARTS

VOLVO

ANODE



802474T

Fits OMC Cobra & Volvo SX sterndrives
Volvo Penta North America, Inc. P/N:3855411-9
3853818-7

OMC

WATER SEPARATING FUEL FILTER



8M0061975

Fits OMC Fuel Filter spin on housing.
 Replaces OMC # 502905
 Outboard Marine Corp. P/N: 502905
 Quicksilver Branded, Box Point of Sale Packaged.

IMPELLER - COBRA



879141

Cobra - 1986-1991
 Outboard Marine Corp. P/N: 983895
 Cobra 1986-1991

WATER PUMP REPAIR KIT



879142

Does not include impeller housing
 Cobra Dr. 1986-1993
 Outboard Marine Corp. P/N: 984461
 Cobra Dr. 1986-1993

ANODE



802474T

Fits OMC Cobra & Volvo SX sterndrives
 Outboard Marine Corp. P/N: 3853818
 1987-93 Cobra
 3855411
 1987-93 Cobra
 984513
 1987-93 Cobra

COMPETITOR PARTS

Part Number to Page Number Reference

394 - 1130A 1	2, 16-18	16061T04	8, 13
11497M	81	16064006	3, 17
11502M	79, 90	16115A03	122, 131
47 - 11590M	98, 115	47 - 16154 1	95, 106, 110
11656T	102, 115	47 - 16154 3	95, 105, 107, 108
27 - 11977A92	213	46 - 16156	103, 105, 108
50 - 12066K10	119, 120	46 - 16156 1	103, 107
50 - 12066Q10	120	46 - 16156 2	103, 110
50 - 12066T03	120	16156A01	105
26 - 12224	231	16159A03	99, 105
12415	117	16253	83, 85
12415A 2	117	16253 2	84, 86
12632A 6	208	16253 3	84-86
12632A 7	208	16254	82, 85
393- 1280A 1	10, 18-20	16254 3	82, 85, 86
32 - 12817	196	26 - 16709A 2	230-232
393- 1293A 1	10, 17-21	16755Q 1	220, 222
13220	172, 176, 177	16755T 1	220
13310T 1	41, 43, 44	17050M	81, 88
57 - 13457Q	207	17068M	80, 91
57 - 13458Q	207	1399- 1717	74, 85-88
27 - 13461A99	121, 135	398- 173	2, 13-16
13524A 6	150, 155	17617	211
13524T 1	151, 155, 156	17649A02	238
13524T12	151, 155, 156	32 - 18159 1	195
13536A13	116	87 - 18211	47, 50, 52
13536A14	117	32 - 18320	195
32 - 13556A 1	200	43 - 18411A 2	224, 227
54 - 13791	121	43 - 18411A 4	224, 227
13838A 1	211	18495A26	8, 19, 20
13843A 2	212	18545A 1	239
27 - 13937 6	72	18643A 5	209
43 - 14063A 1	234, 237	18643A 7	209
26 - 14077	231	18736A21	23
14182M	82, 86	27 - 18785T	128, 135, 136
14360A78	67-71	27 - 18786T	128, 136
14360T74	69-71	32 - 18810	190
14360T75	70, 71	19052A 8	8, 17, 18
14360T77	71	12 - 19183K02	138
14586	117	12 - 19183Q02	138
27 - 14697A87	121, 136, 137	19271 1	81, 87, 88
17 - 14872A 1	242, 243	19273	84, 87, 88
17 - 14873	243	32 - 19403	194
17 - 14873A 1	242, 243	47 - 19453T	95, 106, 107, 110, 111
27 - 15172 4	72	47 - 19453T 2	99, 110, 111
15247T02	166	26 - 19473	232
15248T01	166	87 - 19761	47, 51
15248T02	166	1399- 2015	75, 86-88
15386001	43, 44	20270A 2	103, 109, 110, 114
15899T02	166	47 - 22748	95, 108, 114
15930A15	70, 71	23014A 1	64, 67-70
32 - 16011	193	25661T 1	45, 50-56, 167, 239
32 - 16012	190	398- 2568T 1	2, 13-16
32 - 16021 1	191	27 - 25725	10
16061005	17	27 - 25848	72

Not all parts listed are available for the European, C.I.S., Africa and Middle East Markets.
For more information, please contact your local Mercury, Mariner, MerCruiser or Quicksilver Office.

Part Number to Page Number Reference

27 - 25849	72	26 - 43035A 4	139, 143-145
27 - 25851	72	27 - 43186A 1	213
27 - 29166	10	336- 4318A 2	2, 13-15
392- 2943	238	32 - 43437	202
27 - 29586	73	43713	222
332- 2986A21	7, 20, 21	27 - 43779A87	122, 133, 134
332- 2986A27	7, 17-20	336- 4409A 4	2, 13-15
25 - 29976	231	17 - 44166	243, 244
21 - 30430A 1	63, 67-70	17 - 44166T 1	242, 244
21 - 30430A 2	63, 66-68	17 - 44167A 1	243, 244
21 - 30430A 3	63, 67-70	57 - 44207Q	207
21 - 30430A 7	63, 69, 70	46 - 44292A 3	184, 185
21 - 30430A 8	63, 70-72	336- 4528T 2	2, 13-15
27 - 31402	73	45522A 3	239, 241
31503A 1	64, 66, 67	43 - 45569A 5	224, 227
25 - 31534	222, 231, 232	32 - 45703	244
43 - 31887	235, 236	25 - 45710 1	222
25 - 31986	231	17 - 45738	243
333- 3213A 3	7, 17, 18	43 - 45814A 5	225, 227
32 - 32461	201	32 - 45973	244
26 - 32511A 1	229, 231	32 - 45974	244
26 - 33144A 2	230, 231	1396- 4656	171, 175
32 - 33189	187	46 - 46893A 6	92, 108, 109
25 - 33504	221, 222	27 - 47366T	222
33765T	153, 155	25 - 47389A 2	240-242
33981A06	219	27 - 47453A 1	217
34235Q 1	149	47608A 1	209
34235T	149, 155	47610A15	202
34235T 1	149, 155	32 - 47639	188
25 - 34821	231, 232	32 - 47642	201
27 - 35982	221, 222	398- 4793	28, 35-37
27 - 35996A 1	220, 221	57 - 48120Q 1	207
36405	211	57 - 48122Q	207
57 - 37619Q	207	32 - 48132	194
41219T	238	27 - 48164 1	73
27 - 41244T02	128, 136, 137	46 - 48744A 3	92, 109
27 - 41247T01	128, 136, 137	332- 4895A 5	3, 18-21
26 - 41365A 3	139, 143	332- 4895A 8	157, 162, 164
27 - 41499A88	122, 132	332- 4895T 2	3, 18-21
32 - 41642A 3	189	35 - 49088Q 2	181
43 - 41656T	235, 237	35 - 49088T 2	181
43 - 41657T	234, 237	332- 4911A 2	7, 15
41859M	79, 90	332- 4911A 8	7, 17
32 - 41940	191	393- 4988T 1	152, 155, 156
47 - 42038Q02	95, 105, 108, 109	391- 5075Q 1	154-156
47 - 42038Q 3	105	391- 5090Q 1	149
47 - 42038T 3	99, 108, 109	391- 5090T 1	149, 155, 156
46 - 42089A 2	103, 105, 108, 109	1395- 5109 1	76, 87, 88
46 - 42089A 5	92, 105, 108, 109	1399- 5135	74, 86
27 - 42364A92	122, 131, 132	1399- 5137	80, 86, 87
42431M	102, 115, 116	1399- 5198	75, 86, 87
42909A 4	65, 69, 70	1399- 5199 1	76, 86, 87
27 - 43004A99	122, 134, 135	1399- 5207	72
47 - 43026T 2	95, 106, 107, 111-114, 185	52146	212
26 - 43035A05	139, 143, 144	1396- 5238	172, 175

Part Number to Page Number Reference

32 - 52481	188	63832A 1	202
398- 5255	25, 32	63832T	202
339- 5288T 2	3, 13-15, 17-21	57 - 64032Q 1	207
53245A 1	64, 66, 67	1395- 6452	76, 89, 90
35 - 53336Q	173	27 - 64818Q 4	220-222
35 - 53336T	173	27 - 64818T 4	220
27 - 54014Q 1	220, 222	65057T 1	167
27 - 54395T	222	27 - 65184A88	215
398- 5454A17	28, 35-37	27 - 65373	221
398- 5454A26	27, 35	65533A 1	221, 222
398- 5454A32	28, 37, 38	57 - 65607Q	207
398- 5454A35	28, 37, 38	65864	151, 155, 156
398- 5454A 7	28, 37, 38	26 - 66303A 1	140, 143
32 - 54570	187	27 - 67751 1	73
55278A 1	64, 67, 68, 70	68575 3	41, 43, 44
55278A 4	65, 67, 69	27 - 68714A 7	217
55278A 5	65, 69	57 - 69143Q	207
50 - 55601A 2	38, 43	25 - 69201	232
26 - 55682A 1	139, 145	69354A 2	208
43 - 55778A 3	225, 227	32 - 69871	244
27 - 55896	10	46 - 70941A 3	92, 108, 109
398- 5704A 7	25, 33, 34	27 - 70974	221
46 - 57234T 1	184, 185	32 - 71613	193
57 - 57298Q	207	87 - 71831	150, 155, 156
57380	41, 43	46 - 72774A89	182
332- 5772A 7	7, 16-20	27 - 72863A88	140
1397- 5831	171, 175, 176	27 - 73377 1	73
59078Q 3	186	46 - 73640A 2	92, 110, 111
59078T 3	186	27 - 73645A87	122, 134, 135
47 - 59362A 4	183, 185	73723A01	219
47 - 59362Q08	183	32 - 73794	194
47 - 59362T 1	185	32 - 73795	194
47 - 59362T 6	183, 185	32 - 73796	194
32 - 60198	192	57 - 74271Q	207
32 - 60199	192	339- 7452A19	8, 14-16
32 - 60200	192	74639A 2	221
32 - 60201	192	74639Q02	221
32 - 60203	192	27 - 74830A 3	213
25 - 60342A 2	240, 241	43 - 75325A 3	225, 227
25 - 60342A 3	240, 241	27 - 75611A03	217
46 - 60366Q 1	110	27 - 75611A 2	217
46 - 60366T 1	94, 110, 111	27 - 75611A88	214
60930	206	27 - 75611A96	215
1395- 6200	75, 87, 88	27 - 75611A98	215
339- 6222A 8	7, 13	75660	43, 44
43 - 62879T 1	226, 229	75692	117
392- 6324Q 1	149	27 - 75791 1	73
392- 6324T 1	155, 156	75832T 1	223
392- 6325Q 1	149	1395- 7624	81, 89
392- 6325T 1	149, 155	76314A 3	26, 33
27 - 63309	73	32 - 76327	189
1397- 6367A 1	171, 174	89 - 76416A 1	167
85 - 63709A 1	160	76850A 2	208
32 - 63829	196	26 - 76868	231, 232
63831A 3	202	26 - 76868A04	231, 232

Part Number to Page Number Reference

27 - 76952	73	43 - 803109T 2	224, 227, 228
26 - 77066A 1	140, 142, 143	43 - 803112T 1	223, 227
46 - 77177A 3	93, 110, 111	43 - 803114T 1	223, 227
32 - 77245	189	43 - 803115T 1	223, 227
77442A 1	241	43 - 803116T 1	223, 227
46 - 77516A 3	93	43 - 803118T 1	224, 227
332 - 7778A12	8, 18-22	43 - 803119T 1	224, 227
46 - 77822A 1	103, 110, 111	43 - 803120T 1	224, 227
27 - 78028A78	122, 133	91 - 803146A04	121
57 - 78200Q 1	207	91 - 803146T	121
1395 - 7824	81, 89, 90	27 - 803508	131
1395 - 7826	76, 89, 90	27 - 803508 2	128, 131
27 - 79583 1	128, 136	27 - 803508A05	123, 131
26 - 79831A 1	140, 143, 144	803529T04	67
25 - 79871A 1	240, 242	803529T06	66, 67
24 - 80056M	120	803558T02	8, 10, 11
27 - 801868	213	339 - 803559A02	3, 11
802115	249	339 - 803559T07	3, 11
802119A 1	248	803559T08	3, 10
802125	249	339 - 803559T 1	3, 10, 11
22 - 802196Q	248	27 - 803663A08	123, 132
802332	249	803704T	15
802371A 1	248	803704T01	14
802474T	251, 252	47 - 803748	97, 105, 106
27 - 802567A98	216	47 - 803748 1	97, 105
802706A 1	77, 86	47 - 803748K01	101
31 - 803068T 1	230, 231	47 - 803748K02	101
43 - 803069T 1	232, 237	47 - 803748Q01	105
43 - 803071T 1	232, 237	47 - 803748Q02	105
43 - 803073T 1	232, 237	46 - 803750A02	104, 105
43 - 803074T 1	232, 237	46 - 803750A03	93, 105
43 - 803079T 1	232, 236	46 - 803750A05	104-106
31 - 803080T02	230, 231	46 - 803750T05	104, 106
43 - 803081T02	232, 237	50 - 803835T02	39, 44
31 - 803082T02	230-232	803836	41, 44
43 - 803083T02	233, 237	803837A02	44
31 - 803085T02	230, 232	803844T	24, 30
43 - 803087T02	233, 237	803844T01	24, 30
43 - 803088T02	233, 237	1395 - 803861	82, 86, 87
43 - 803089T02	233, 237	47 - 80395M	98, 115
31 - 803090T 1	230, 231	24 - 804024008	119, 120
43 - 803091T 1	232, 237	24 - 804024T07	119
31 - 803094T 1	230, 231	27 - 804115 1	129, 134, 135
31 - 803096T 1	230, 231	804184	84, 88
30 - 803097T 1	221, 222	804249T 1	69, 70
30 - 803098T 1	221, 222	398 - 804262T	26, 35, 36
30 - 803099T 1	221, 222	804269T 2	8, 12
43 - 803101T 1	223, 227	339 - 804271T	4, 12
43 - 803102T 1	223, 227	804316	44
43 - 803103T 1	224, 227	804319	42, 44
43 - 803104T 1	224, 227	804320	42, 44
43 - 803105T 1	224, 227	27 - 804345A02	123, 134, 135
43 - 803106T 1	224, 227	804346T02	77, 88
43 - 803107T 2	224, 227-229	3302 - 804689	174-176
43 - 803108T 2	224, 227-229	3302 - 804844002	171, 173-176

Part Number to Page Number Reference

3302-804845	171, 173-175	32 -807404	195
805134A 4	239	32 -807405	196
32 -805251	195	32 -807406	197
805320A03	239	32 -807406 1	197
25 -805331	232	32 -807407	198
805361T 2	166	32 -807407 3	198
805361T 5	166	807645A01	166
27 -805396A92	216	32 -807661	188
27 -805396A95	216	27 -807670A03	215
43 -805448A 1	234, 237	27 -807670A96	215
32 -805469	198	32 -807697	191
805536A 2	223	57 -807755Q04	207
805561T	203	57 -807755Q05	207
805561T 1	203	27 -807756A01	214
805759Q01	154	27 -807756A02	214
805759Q 3	153	3310-807764A 1	174
805759T05	153, 155, 156	32 -807989	197
805759T 1	154-156	808029T	204
805759T 3	153, 155, 156	32 -808032	193
80606M	64	32 -808033	190
32 -806209 1	190	32 -808044	195
806426T	203	32 -808044 1	193
806428T	203	32 -808045	193
32 -806433	188	808483K 1	152, 155, 156
32 -806635 1	191	808483K 2	152, 156
32 -806636 1	191	808483Q 1	152
806673T 1	157, 162, 163	808483Q 2	152
806745A01	166	808483T 3	154-156
32 -806856	190	808693A 1	211
27 -806871A96	214	809449A 1	77, 87
806956A01	166	809463A 1	44, 45
806958A01	166	809569	84, 86, 87
806959A01	166	809570	82
806960A01	166	809570002	83, 86
806961A01	166	809570 1	82, 86, 87
32 -806993	189	809594A 1	77, 87
26 -807006	231, 232	809907002	211
23 -807073	244	809908 1	212
807085A01	166	809909	212
46 -807151A14	182	91 -809929	212
807166A 1	206	91 -809938	213
807166A 2	206	810738	84, 89, 90
807166A 3	206	810749 2	75, 89, 90
32 -807201	199	810749 3	76, 89, 90
807252Q 3	186	27 -810846A05	213
807252Q 4	186	27 -810846A06	213
807252Q 5	186	3310-810929004	172
807252T 3	186	811038M	80, 90
807252T 4	186	1395-811223 1	75, 87, 88
807252T 5	186	811534	175-177
807264A01	166	27 -811547A92	215
3310-807312A 1	175, 176	27 -811572A94	216
807371T	203	811598	2, 13
807371T 1	203	811635K 2	152, 155
807372T	204	811635Q 2	152

Part Number to Page Number Reference

811635T 3	153, 155	84 -816608Q80	159, 163
1395-811690 1	82, 89, 90	84 -816608Q81	159, 163, 164
1395-811691 2	77, 89, 90	84 -816608Q82	158, 161
1395-811691 3	77, 89, 90	84 -816608Q83	159, 162–164
57 -812427Q	207	84 -816761Q10	159, 164, 165
24 -812645T	119	84 -816761Q12	158, 163
24 -812645T10	119	84 -816761Q13	157, 160
27 -812867A97	123, 133, 134	84 -816761Q14	158, 160
27 -812939T25	128, 132	84 -816761Q16	158, 161
812953	77, 87, 88	84 -816761Q17	159, 161–163
46 -812966A12	93, 103, 106, 107, 110, 111	84 -816761Q 3	159, 162, 163
33 -813415	162	84 -816761Q 4	159, 161–163
33 -813421 4	164, 165	84 -816761Q 5	157, 160, 161
33 -813425	161, 163	84 -816761Q 7	158, 161
33 -813471 1	160, 161	84 -816761Q 8	158, 161
27 -814195A93	124, 137	84 -816761Q 9	158, 161–164
47 - 81423M	99, 116	89 -817109A 2	45, 49, 53–57
26 -814242	231	817275 2	106
814453M	101, 115	817275A08	94, 107, 114
814481M	80, 90	817275A09	94, 107, 114
26 -814669A 2	140, 144	817275A 1	104, 107, 114
32 -814749	197	817275A10	104, 107
27 -815076A04	124, 130	817275A 2	105–107, 111–114
815113T02	4, 13	817275A 5	93, 114
815279A 2	23	817275A 6	93, 114
1399- 8153	76, 86	817275K05	184, 185
1399- 8154	75, 80, 86	27 -818572A98	216
815407A 2	153, 155	25 -818573	127, 136, 137
815407Q02	153	818574	127, 136, 137
815407Q 5	152	32 -818741	195
815407T 5	152, 155	89 -818864T	46, 56, 57
32 -815412	188	43 -818928A 2	234, 237
32 -815413	188	89 -818997T 1	46, 53–57
815471T 1	219	89 -818999A 2	45, 51, 52, 167
26 -815565	231	820620	43, 44
26 -815565A02	231	26 -820645A 1	141
27 -815791A00	135, 136	57 -821023Q	207
27 -815791A92	124, 135, 136	26 -821092	231, 232
23 -815950 1	243	821125A 1	166
17 -815953A01	243	821125T02	166
57 -816034Q	207	46 -821351A 3	105, 106, 109–111
32 -816197	195	821354A04	101, 106
57 -816295Q	207	821354A 2	100, 106, 109–111
33 -816336Q	160–164	32 -821417	195
32 -816347	200	32 -821418	196
32 -816504	197	821509T01	47–49
26 -816575A 3	230, 231	398 -821935A 5	29, 38
26 -816575A 4	140, 145	27 -822420A94	124, 132, 133
26 -816575A 5	140, 145	43 -822535A 1	234, 237
26 -816575A 6	145	27 -822844T05	129, 136
84 -816608Q61	159, 164, 165	823033	4, 13
84 -816608Q68	159, 162–165	823034T	8, 13
84 -816608Q70	159, 162, 163	823426A 1	171, 174–177
84 -816608Q71	159, 162	823427A 1	171, 173, 174
84 -816608Q78	159, 163	823547A03	141, 143, 144

Part Number to Page Number Reference

823547A 2	141, 143, 144	835399T	26, 30, 31
1395-823620	84, 87	835401T02	11
1395-823635 4	78, 87, 88	835401T06	9, 11
823640 1	43, 44	835401T 1	9, 11
823640T	43, 44	27 -835427A00	125, 131, 132
1395-823707 2	78, 86, 87	27 -835427A04	125, 131
823727	174	24 - 83588M	120
26 -823894	231	47 - 84027T	98, 115
43 -824109A 1	236, 237	43 -840898A 3	226, 228
27 -824326A02	214	841080T01	180
27 -824326A03	214	841203T	165
27 -824326A93	213	27 -841220A03	125, 137
43 -824517A 1	234, 237	84141M	64
27 -825032	129, 133, 134	32 -841452	194
398-825089 1	26, 33, 34	84181T	102, 115
339-825101T	4, 12	84188T	103, 116
27 -825231A02	124, 132, 133	43 -841910A01	235, 237
27 -825231A99	132, 133	27 -842129A 1	217
826398T 3	67, 68	27 -842182A 1	217
43 -827303	234, 237	32 -842412A02	188
43 -827304T	235, 237	32 -842416A 1	187
827509A10	9, 16–20	84262M	81
827509A12	9, 16, 17, 22	84265M	81
827509T 7	9, 16–18, 21, 22	46 - 84277T	102, 115
827589T 1	212	27 -843073A06	217
827643	211	84363T	102, 116
43 -828073A 1	235, 237	32 -844475	198
43 -828289A 1	233, 237	84473T	79, 90
43 -828290T 2	236, 237	32 -844881	197
27 -828319	73	32 -844882 1	193, 198
43 -828336A 1	235, 237	32 -847677A01	188
27 -828553A97	124, 132, 133	84 -847701Q17	159, 164
27 -828925	74	84 -847701Q18	164
27 -830270A02	124, 132	84 -847701Q24	159, 162
339-830404T 3	4, 11	84 -847701Q25	159, 165
26 -830749A01	141, 145, 146	84 -847701Q26	159
26 -830749A02	146	84 -847701Q 7	159, 164, 165
1395- 8318 1	81, 85, 87, 88, 90	47 - 84797M	98, 115, 116
27 -832013A96	124, 133, 134	32 -848178	196
398-832074A11	26, 32–36	32 -848954	199
398-832074A 4	27, 35, 36	32 -848955	200
398-832074A 6	26, 32, 33	32 -848956	197
398-832075A15	25, 32	849291	204
398-832075A19	26, 33–36	43 -849320T	228
398-832075A20	25, 32, 33	32 -849604	196
398-832075A21	25, 32–37	849930T02	180
398-832075A 5	27, 33–36	32 -849935	196
398-832075A 6	27, 35, 36	32 -849936	200
398-832075A 7	27, 34–36	32 -849937	200
398-832075A 8	27, 35, 36	32 -849938	200
398-832075A 9	25, 32	32 -849939	199
339-832757A 4	4, 14–22	32 -849940	200
27 -832934A00	125, 136, 137	32 -849941	200
27 -834777	132, 133	32 -849943	199
835389T02	66, 67	849952A03	204

Part Number to Page Number Reference

850055001	117	27 - 85653A87	122, 135
50 -850057K01	119	32 -856706	196
89 -850187T 1	45, 48, 50–55, 167	54 -856880	121
89 -850188T 1	46, 50–52, 167	339 -856991A 1	4, 21, 22
89 -850189T	46, 50	21 -857005A 1	64, 67–71
54 -850241	121	398 -858404T 4	29, 37, 38
27 -850470A96	215	858452 1	128, 136
850484T 2	154, 155	27 -858732A03	125, 134, 135
850484T 3	152, 155	27 -858732T02	125, 135
1395- 8506	76, 89	339 -858942T 1	5, 11
27 -850836001	129, 131	11 -859116K01	219
47 - 85089 10	95, 105, 106, 109–111	11 -859116Q01	219
54 -850896	121	50 -859168T	39, 44
47 - 85089T 4	99, 109	27 -859352A01	125, 133, 134
26 - 85090A 2	140, 143	27 -859352A02	125, 132, 133
85152T	202	339 -859738T 1	5, 11, 12
21 -851812A01	66, 67	859772 1	127, 136
87 -851839T02	47, 48	3310-860070A 2	173, 174
851990	44	3310-860071A 2	174
852082	44	3310-860071A 4	174
398 -852386T 6	27, 31, 32	32 -860089 1	193
398 -852386T 8	24, 27, 31, 32	860125T	210
398 -852387T 9	25, 28, 31, 32	32 -860144	191
24 -852778	119	32 -860205	190
43 -853593A 1	235, 237	32 -860206	190
43 -853640A 2	225, 227	32 - 86036Q	244
43 -853641A 2	225, 227	57 -861049A 1	208
43 -853642A 2	225, 227	57 -861049A 2	208
43 -853643A 2	225, 227	57 -861049Q	208
89 -853654A 1	46, 50–57, 168, 239	3310-861080A 1	175
853792A07	101, 106	861155A16	179
853792T01	101, 110	861155A 3	179
853806 1	42, 44	861155A 6	179
89 -853809001	46, 48	32 -861183	187
89 -853809002	48	27 -861246A05	214
89 -853809T	50	27 -861246A06	214
854247	83, 87, 88	27 -861246A99	215
854253	84, 87	861251A 1	166
854253 1	85, 87, 88	861251T 1	166
854256	78, 87	861252A 2	166
854256 1	78, 87, 88	861252T 1	166
1397- 8548	174–177	861253T02	166
27 - 85491A90	122, 132, 133	861254T02	166
54 -855228	121	861255T02	166
855546A 1	78, 85	32 -861318	199
855546A 3	78	861459T02	166
855546A 4	78, 85	861460T02	166
43 -855651A 1	234, 237	32 -861512	193
43 -855652T 1	236, 237	861523A11	209
855685T	4, 11	861543T02	166
54 -855697	121	32 -861590A05	187
855713A 3	9, 14–16	32 -861634	189
855713A 4	9, 14–16	861677A 2	179
855721T 8	24, 30, 31	861677T	178
47 - 85647	95, 114	26 -861694	232

Part Number to Page Number Reference

57 -861757A 1	208	57 -865615Q10	207
57 -861757Q	208	57 -865615Q11	208
57 -861758A 1	208	57 -865615Q12	207
57 -861758Q	207	57 -865635Q01	208
57 -861759A 1	208	57 -865635Q02	207
57 -861759Q	208	86611A 1	240, 242
33 -862029	164	866136A01	223
862048A 1	178	3310-866142A04	175
57 -862054Q	207	3310-866143A03	176
862077A 1	178	866169T01	180
32 -862124	191	866170A01	180
862132T	223	86617A17	24, 31
32 -862139	192	86617A20	24, 30-32
862264A 7	179	32 -866331	201
86234A05	178	27 -866449A01	220
86247T	178	86704A10	25, 32
862776A01	182	1395- 8673	83, 85-88
862776A02	182	24 -86857T01	119, 120
862837T	204	32 -87117 1	191
862975A 1	209	87173A10	241
862975A 2	209	32 -87234	244
84 -863656A03	159, 163, 164	32 -87235	245
84 -863656A04	158, 161	87399A 2	240, 241
84 -863656A05	159, 162, 163	87399A 3	240, 241
84 -863656A 1	159, 162-164	25 -87400A 2	240, 241
84 -863656A 2	158, 161	87411A 6	242
863674A04	182	87412A 3	242
863674A05	182	32 -87558	245
863820T 1	204	32 -87559	245
863832T01	204	1397- 8760	171, 175
863842T02	205	1397- 8767Q	173
863904T	205	1397- 8767T	172
32 -864588	245	339-877807A 2	5, 11, 12
32 -864589	245	84 -878074A 2	61
3310-864942A01	175	43 -878087A 2	233, 237
3310-864943A01	176	43 -878087A 4	233, 237
32 -864959	245	398-878143T05	29, 32-34
32 -864960	245	878453	127, 136, 137
86 -865202T	168	26 -878461 2	61
865330A02	219	26 -878461 3	61
865380A13	238	26 -878461 4	61
865380A25	238	26 -878462	62
865436A02	219	26 -878463 2	61
865436A03	219	26 -878463 3	61
865437A02	220	26 -878463 4	62
865496A02	223	26 -878463 6	62
57 -865615Q01	208	26 -878464 2	62
57 -865615Q02	207	26 -878464 6	62
57 -865615Q03	208	26 -878464 8	62
57 -865615Q04	207	26 -878465	62
57 -865615Q05	207	26 -878466	61
57 -865615Q06	208	43 -878617A 2	233, 237
57 -865615Q07	208	878823A 1	248
57 -865615Q08	208	878952A 2	249
57 -865615Q09	207	879012	248

Part Number to Page Number Reference

879014	248	50 - 881368T 2	39, 44
879054A 1	249	881371T 1	41, 44
879055A01	249	392-881732	157, 165
879126	250	882751	46, 49, 168
879141	252	882751A04	48, 49, 168
879142	252	882751A 1	46, 48-57, 168
879147T69	31	882751A 3	47, 49
339-879147T71	5, 11	88302A 1	218
50 - 879150A85	40, 44	883166A 2	238
1395-879194011	82, 87, 88	883169A 1	239
1395-879194024	75, 87, 88	43 - 883473A 2	226-229
1399-879194026	78, 86	43 - 883473A 3	226-229
879194T52	205	43 - 883473A 4	226-229
879194T60	205	43 - 883476A 2	226-229
879288A10	166	43 - 883476A 3	226-229
57 - 879288Q20	208	43 - 883476A 4	225, 227-229
57 - 879288Q21	208	43 - 883479A 2	226-228
879288T34	151	43 - 883479A 3	226-229
879288T46	205	43 - 883479A 4	226-229
50 - 879345T77	40, 44	27 - 883599A02	126, 133, 134
879346A31	58	26 - 88397A 1	229, 231
879346A32	58	884391	136, 137
879346A33	58	84 - 88439A25	23
879346A34	58	84 - 88439A26	24
879346A35	58	84 - 88439A50	23
879346A36	58	27 - 88449A32	122, 133, 134
879346A37	58	27 - 887810A04	126, 137
879346A38	58	27 - 887848002	129, 137
879346A39	59	27 - 887848003	129, 137
879346A40	59	43 - 887903A 1	226, 228, 229
879346A41	59	43 - 887906A 1	226, 228, 229
879346A42	59	43 - 887909A 1	226, 228, 229
879346A43	59	32 - 88794	190
879346A44	59	32 - 88795	189
879346A45	59	32 - 88795 2	192
879346A46	59	339-888309	6, 12
879346A47	59	888320T	47, 49
879346A48	60	50 - 888333T 1	39, 44
879346A49	60	888335	44
879346A50	60	888339A 1	41, 44
879346A51	60	54 - 888441	121
879346A52	60	22 - 88847A 1	218
879346A53	60	888686T	105, 107
27 - 879855A04	126, 134, 135	888687A 1	107
27 - 880552A07	126, 137	47 - 888689	97, 107
339-880615T01	5, 12, 13	54 - 888988019	121
43 - 880805A 1	42, 44	889246A16	105
880890A02	69, 70	889275T	179
880890T 1	69, 70	27 - 889924A01	216
339-880892001	5, 12	27 - 889924A02	216
84 - 881262A 2	58	27 - 889924A03	216
398-881336A03	35, 36	392-889925	157, 165
398-881336T 2	29, 36	89031A 1	65, 69, 70
881352T	47, 49	89031A 2	65, 70-72
881356001	47, 49	89031A 3	65, 69, 70

Part Number to Page Number Reference

89031A 4	65, 71	47 - 89982T 1	100, 109
891730A01	85, 87	47 - 89983T	96, 109–111, 114
891736T	238	47 - 89983T 1	100, 110, 111
27 - 89221 1	73	47 - 89984Q 5	113, 184
27 - 89221A80	123, 136, 137	47 - 89984T 3	96, 97
27 - 89221A88	123, 136	47 - 89984T 4	96, 111–114, 185
50 - 892339T01	39, 44	47 - 89984T 5	96, 100, 111–114, 184, 185
26 - 89238A 2	140, 145	899883229	9, 14, 15
50 - 893886T	39, 44	27 - 8M0024565	130, 134–137
50 - 893887T	39, 44	27 - 8M0033476	130, 137
50 - 893888T	39, 44	50 - 8M0033984	40, 44
50 - 893890T	40, 44	8M0044575	79, 85, 86
50 - 893891T	40, 43, 44	8M0044576	79, 86
50 - 893892T	40, 43, 44	8M0044577	79, 86
895338	118	300 - 8M0044991	6, 12, 157, 161, 164
23 - 89574	243	300 - 8M0045124	6, 11
895764A01	139	57 - 8M0045227	208
27 - 896142A07	126, 136, 137	3310 - 8M0045397	174
33 - 896329818	160	27 - 8M0045578	216
32 - 89653	189	8M0045696	205
89690T	202	57 - 8M0045986	207
32 - 896998	198	33 - 8M0046007	162
32 - 896999	198	27 - 8M0046714	127, 136
32 - 897142	197	27 - 8M0046715	127, 136
32 - 897145	194	35 - 8M0046751	181
32 - 89718 1	187	35 - 8M0046752	181
32 - 89718 3	187	3310 - 8M0047212	177
32 - 89730 1	198	8M0047313	6, 15
32 - 89749 1	199	27 - 8M0049885	129, 132
27 - 897534A07	126, 134, 135	8M0050085	60, 170
898101288	85	8M0050324	60
27 - 898101928	123, 130	8M0051206	210
898101T01	29, 31, 32	8M0051418	211
27 - 898101T41	130, 132	27 - 8M0052705	129, 131, 132
898103245	85	8M0052921	139
27 - 898103A67	126, 130	8M0054588	157, 161–164
898103A68	85	8M0056334	24, 30
339 - 898103T	6, 11	8M0056379	11
898103T58	6, 10	8M0057697	49, 168
898253T23	154, 155	8M0057716	141, 145
898253T24	6, 18–20, 156, 160–165	27 - 8M0057763	127, 136
898253T27	156, 160–165	8M0058164	178
898253T28	152, 155	8M0058226	23
33 - 898264001	160–165	22 - 8M0058388	138
50 - 898265003	40, 44	22 - 8M0058389	138
50 - 898265010	38, 40, 43	26 - 8M0058390	138
392 - 8989	238	26 - 8M0058391	138
899106T	67	43 - 8M0060003	226–229
84 - 899329A09	160, 165	43 - 8M0060004	226, 228, 229
89977A 1	66, 67	43 - 8M0060005	226–228
47 - 89980	96, 107–109	8M0061040	94, 107
47 - 89980T 1	100, 108, 109	8M0061335	153, 155, 156
47 - 89981	96, 108, 109	8M0061384	218
47 - 89981T 1	100, 108, 109	8M0061975	252
47 - 89982	96, 109	84 - 8M0062009	168

Part Number to Page Number Reference

84 -8M0062010	169	8M0088080	142, 145
84 -8M0062011	169	8M0088081	142, 145
84 -8M0062012	169	57 -8M0088876	207
84 -8M0062013	169	27 -8M0089636	141, 143
84 -8M0062014	169	8M0090764	78, 85
84 -8M0062015	169	27 -8M0090776	130, 134, 135
84 -8M0062016	169	32 -8M0090859	202
84 -8M0062017	169	8M0094529	94, 107
84 -8M0062018	169	33 -8M0095454	161, 164
84 -8M0062019	169	84 -8M0095475	158, 161
84 -8M0062020	170	8M0095485	221, 222
84 -8M0062021	170	50 -8M0096343	41, 44
84 -8M0062022	170	8M0096940	168
84 -8M0062023	170	57 -8M0097728	207
84 -8M0062024	170	8M0098795	209
84 -8M0062025	170	8M0098796	209
84 -8M0062027	170	8M0098898	45, 48, 49
8M0062084	150, 155	47 -8M0100526	101, 107, 185
32 -8M0062614	201	47 -8M0100527	99, 106, 107, 111-114, 184, 185
32 -8M0062634	201	8M0103028	218
32 -8M0062665	201	47 -8M0104229	183, 185
32 -8M0062666	201	84 -8M0104881	164
8M0062770	180	8M0108208	209
8M0062771	180	32 -8M0109048	201
8M0065064	141, 145, 146	8M0110704	119
8M0065070	242, 243	50 -8M0110715	119, 120
8M0065258	44	46 -8M0113799	92, 106, 107, 111-113
8M0069808	212	46 -8M0113801	92, 106, 107
32 -8M0071007	187	33 -8M0114747	165
8M0073435	178	8M0114792	211
27 -8M0077448	141, 143	27 -8M0114820	74, 123, 131
339 -8M0077471	5, 11, 12, 19-22	8M0117413	117
339 -8M0077473	6, 21, 22	84 -8M0117678	160, 165
8M0078858	94, 107	8M0118062	182
27 -8M0079064	126, 132	27 -8M0118179	129, 133, 134
300 -8M0079202	156, 161-165	8M0118958	241
8M0080264	99, 107	8M0118959	241
43 -8M0080756	224, 227	8M0118960	241
8M0082721	153, 155	8M0118961	241
27 -8M0082878	141, 142	8M0120191	174-176
8M0082880	138	8M0120192	172, 175, 176
27 -8M0082881	142	8M0120193	172, 175-177
27 -8M0082883	142, 143	8M0120196	172, 174
27 -8M0082884	142, 143	8M0120197	172, 174
22 -8M0083059	138	339 -8M0121257	12
22 -8M0083060	138	46 -8M0122064	106
8M0084173	23	300 -8M0123821	5, 12
3310 -8M0084193	174	8M0125845	180
3310 -8M0084194	174	8M0125846	179
27 -8M0084273	124, 132	8M0125852	180
21 -8M0084275	63, 67, 69	8M0125855	204
21 -8M0084276	63, 69	8M0125858	205
21 -8M0084277	63, 69, 70	8M0128692	241
57 -8M0087881	207	8M0128693	241
300 -8M0088059	29, 35, 36	33 -8M0129146	165

Part Number to Page Number Reference

8M0132609	241	1395- 9169 1	83, 86, 87
8M0132610	241	91755T	79, 90
8M0133642	23	43 - 92320T	235, 236
27 -8M0134073	142, 143	1395- 9258 1	81, 85-88
27 -8M0134437	130	1395- 9262 1	77, 85-88
27 -8M0134438	127	32 - 92837	194
8M0134470	29	92864	178
8M0134472	7, 11	1395- 9293	83, 86, 87
50 -8M0134475	41	93224A 1	104, 108, 109
8M0135544	44	93247A 7	238
8M0135711	41	35 - 93568	173
47 -8M0135803	97	57 - 93658Q	207
98 -8M0135820	142	3302- 9407	173-175
98 -8M0135821	94	57 - 94290Q	207
47 -8M0137219	183, 185	393- 9459Q 1	153, 155
98 -8M0137220	183, 185	94993A12	218
98 -8M0137221	183, 185	27 - 94996Q 2	220, 222
50 -8M0137769	40, 44	27 - 94996T 2	220
8M0139434	118	27 - 95220A 1	143
8M0141827	66-68	95259	84, 85
50 -8M0147039	39, 44	95263 1	85
8M2001321	179	95263A 1	82
33 -8M2018369	161-164	47 - 95289 2	96, 107
57 -8M2018590	207	24 - 95484M	120
57 -8M2018984	208	47 - 95533M	98, 115, 116
27 -8M6000366	136	47 - 95611M	98, 115
8M6001106	154-156	95661T	102, 115, 116
8M6001217	155, 156	1395- 9594	83, 87, 88
8M6001218	155	89 - 96054T	45, 50-57, 167
8M6001219	149, 155, 156	43 - 96084A 4	233, 236
8M6001221	150, 155	43 - 96084A 7	233, 236
8M6001222	151, 155, 156	398- 9610A19	28, 37, 38
8M6001224	151, 155, 156	398- 9610A 5	28, 37, 38
8M6001249	155, 156	46 - 96148A 8	111-114, 184, 185
8M6001250	150, 155, 156	46 - 96148Q 8	184
8M6001251	150, 155	46 - 96148T 1	104, 111-114
8M6001252	151, 156	46 - 96148T 8	184
8M6001253	151, 155, 156	89 - 96158T	45, 50-57, 167, 239
8M6001254	150, 155	32 - 96246A 4	192
23 - 90203	244	27 - 96281T01	128, 135, 136
1395- 9022	82, 86, 87	47 - 96305M	98, 115
1395- 9023	76, 87	1395- 9648 1	77, 86
1395- 9024	75, 80, 87	1395- 9650	77, 87
1395- 9026	76, 86	1395- 9651	75, 87
1395- 9027	74, 86	3302- 9655 1	173-176
90363A 1	65, 71	96562	41, 43, 44
27 - 90430 1	73	96563T	44
3302- 9046	173-175	57 - 96834Q	207
26 - 90562	231	47 - 97108M	99, 116
90643	42-44	32 - 97385 2	199
90643 1	42, 44	32 - 97385 3	199
90643 2	42, 44	33 - 97389	160, 161
90645	42-44	97432A 2	209
50 - 90892A 2	119	1395- 9761 1	64, 66, 67, 74, 80, 86, 87
392- 9089T	150, 155, 156	97667T	80, 90, 91

Part Number to Page Number Reference

392- 9766Q 1	154-156
97793T	102, 115, 116
10 - 97934A 1	218
32 - 98033A 3	189
98337T	212
98703A10	241
98703A 3	241
98704A 3	241
398- 9873A38	26, 33, 34
27 - 98769 1	64
1399- 99	72
99155T 1	186
99155T 2	186
46 - 99157A02	104, 105, 109
46 - 99157T 2	94, 105, 109
23 - 99291T	243
99356A 1	203
99356A 2	203
99370A 2	206
32 - 99904Q	245
47 - 99971M	98, 116
F10265	83, 87
F12044	2
F15190	44
27 -F433168	74
27 -F433406	74
47 -F436065-2	97
27 -F440906	74
47 -F462065	97
27 -F481836	74
F528068	117
F664068	118
47 -F84065	97
FK1061	139
FK1063-2	139
NLA	31-34, 38, 43, 44, 90, 131, 135, 136

OE to Quicksilver Cross Reference

GLM Marine GLM

OE Part No.	Description	QS Part No.
GLM Marine GLM		
40410	Gasket Set	1395- 6200
40420	Gasket Set	1395- 6452
40435	Gasket Set	1399- 1717
40460	Gasket Set	1399- 5135
40460	Gasket Set	1399- 5198
40900	Inlet Needle & Seat Assembly	1395- 7824
40910	Inlet Needle & Seat Assembly	1395- 8318 1
70010	Points	8M6001219
70060	Points	8M6001250
70660	Condenser	394- 1130A 1
71040	Rotor	8M6001224
72120	Ignition Coil	398- 173
76081	Carburetor Repair Kit	1396- 4656
76083	Carburetor Repair Kit	1397- 6367A 1
76096	Carburetor Repair Kit	1396- 5238
76106	Carburetor Repair Kit	1397- 5831
76107	Carburetor Repair Kit	1397- 5831

Mallory Mallory

OE Part No.	Description	QS Part No.
Mallory Mallory		
25042	Points	8M6001250
25676	Rotor	8M6001224
25678	Rotor	8M6001224
309	Rotor	8M6001224

Part Description Index

A

Access Hole Plug Kit	218
Adapter Kit CDM	9
Alternator Harness Service End	58
Anchor Front Pin	243
Anchor Front Pin Kit	242
Anchor Front Pin Rear	243
Anchor Kit Front Pin	242
Anchor Pin Kit	242
Anchor Rear Pin	243
Anode	251, 252
Armature, P/T Pump Motor	238

B

Base Kit Water Pump	184
Base Water Pump Kit	184
Battery Cable	23, 24
Battery Cable Kit	23
Bearing Cross	223
Bearing Kit Seal	230
Bearing Seal Kit	230
Bell Housing Hose	201, 202
Bellows Shift Cable	221
Belt Kit Serpentine	208
Belt Serpentine	207, 208
Belt Serpentine Kit	208
Bolt Engine Kit	218
Bolt Kit Engine	218
Boost Pump Kit	179
Brush Kit	10
Brush Set	238

C

Cable Battery	23, 24
Cable Battery Kit	23
Cable Shift	219, 220
Cable Shift Bellows	221
Cable Shift Kit	219
Cap Kit Rotor	152, 153
Cap Rotor Kit	152, 153

Carburetor Float Assembly	85
Carburetor Fuel Filter	172, 173
Carburetor Gasket Kit	172
Carburetor Gasket Nozzle	248
Carburetor Gasket Set	75
Carburetor Kit	249
Carburetor Kit Gasket	172
Carburetor Kit Repair	76–80, 171, 172
Carburetor Nozzle Gasket	248
Carburetor Repair Kit	76–80, 171, 172
CDI Unit	8, 9
CDM Adapter Kit	9
CDM Harness Seal	61
CDM Module Assembly	9
Check Valve Kit	63
Circulating Hose Pump	187, 188
Circulating Pump Hose	187, 188
Clamp Hose	121
Clamp Hose Kit	121
Coil	5, 6
Coil Harness Seal Ignition	61
Coil Ignition	2–7, 156, 157, 248
Coil Ignition Charging	24
Coil Ignition Harness Seal	61
Coil Ignition Kit	6
Complete Water Pump	94
Condenser	2
Connector Fuel Line	248
Conversion ICM Module Kit	166
Conversion Kit ICM Module	166
Cooler Oil	202–205
Coupler Engine	208, 209
Cover Assembly	103, 104
Cover Float Bowl Gasket	72
Cover Impeller Housing	182
Crank Sensor Harness	61
Crimping Tool	121
Cylinder Head Gasket	130
Cylinder Trim Kit O-Ring	240

D

DDT Harness Seal	61
Diaphragm Fuel Pump	64, 81
Diaphragm Gasket Kit	64, 74, 75, 80
Diaphragm Kit	64–66, 80
Direct Harness Injector	60, 170
Direct Harness Injector Seal	62
Direct Injector Harness	60, 170
Direct Injector Harness Seal	62
Distributor Cap	153, 154
Drain Gasket Screw	138
Drain Screw	138
Drain Screw, Gearcase	138
Drain Screw Gasket	138
Drain Screw Gearcase	138
Drain Screw Seal	138
Drive Installation Kit	220
Drive Kit	42, 43
Driven Gear	226
Drive Retainer Kit	43

E

Electric Fuel Pump	179, 180
Engine Bolt Kit	218
Engine Coupler	208, 209
Engine Drive Plate	209, 210
Engine Mount Rear	218, 219

F

Filter Fuel Pump	181
Filter Fuel Water Separating	252
Float Assembly	83–85
Float Bowl Gasket	248
Front Anchor Pin	243
Front Anchor Pin Kit	242
Front Anchor Pin Rear	243
Fuel Connector Line	248
Fuel Filter Carburetor	172, 173
Fuel Filter Pump	181
Fuel Filter Water Separating	252
Fuel Injector Harness	60

Fuel Line Connector	248
Fuel Pump	66, 178–180
Fuel Pump/Cooler Kit	179, 180
Fuel Pump Assembly	66
Fuel Pump Diaphragm	64, 81
Fuel Pump Electric	179, 180
Fuel Pump Filter	181

G

Gasket	10, 64, 72–74, 129
Gasket Carburetor Kit	172
Gasket Carburetor Nozzle	248
Gasket Carburetor Set	75
Gasket Cover Float Bowl	72
Gasket Cylinder Head	130
Gasket Diaphragm Kit	64, 74, 75, 80
Gasket Drain Screw	138
Gasket Float Bowl	248
Gasket Float Bowl Cover	72
Gasket Head	128–130
Gasket Kit Carburetor	172
Gasket Kit Diaphragm	64, 74, 75, 80
Gasket Overhaul Set	213–217
Gasket Set	74–76, 121–127, 140, 216, 217
Gasket Set, Lower Unit	141, 142
Gasket Set Carburetor	75
Gasket Set Overhaul	213–217
Gasket Water Pump	217
Gearcase Drain Screw	138
Gearcase Seal Kit	141, 142
Gear Drive	234
Gear Driven	226
Gear Kit	224–226
Gear Pinion	235
Gear Repair Kit	223, 224, 232, 233
Gear Set	233–235
Gimbal Housing Access Hole Plug Kit	218
Gimbal Ring Kit	218

H

Harness Alternator Service End	58
--	----

Part Description Index

Harness Connector	58–60	Inlet Seat Needle Assembly	81, 82
Harness DDT Seal	61	Installation Hardware Sterndrive	219
Harness Direct Injector	60, 170	Installation Kit Drive	220
Harness Direct Seal Injector	62		
Harness Fuel Injector	60	L	
Harness Repair	58–60	Lower Unit Seal Kit	142
Harness Repair Kit	168–170		
Harness Sensor Crank	61	M	
Harness Sensor Seal MAP	61	MAP Harness Sensor Seal	61
Head Gasket	128–130	Module Conversion Kit ICM	166
Head O-Ring	127	Module ICM	166
Head Seal	127, 128	Module ICM Conversion Kit	166
Hose	188–201	Module Ignition	166
Hose Bell Housing	201, 202	Motor Armature, P/T Pump	238
Hose Circulating Pump	187, 188	Motor Assembly Starter	38–40
Hose Clamp	121	Motor Starter Assembly	38–40
Hose Clamp Kit	121	Motor Starter Kit	38
Hose Power Trim	244, 245		
Housing, Upper	103, 104	N	
Housing Water Pump	104	Needle Inlet Assembly	82, 83
		Needle Inlet Seat Assembly	81, 82
I		Needle Seat	248
ICM Module	166	Nozzle Carburetor Gasket	248
ICM Module Conversion Kit	166		
Ignition Assembly Stator	24, 25, 27–29	O	
Ignition Charging Coil	24	Oil Cooler	202–205
Ignition Coil	2–7, 156, 157, 248	Oil Pump	211, 212
Ignition Coil Kit	6	Oil Pump Harness Seal	61
Ignition Harness Coil Seal	61	Oil Pump Pickup Tube Installer	212, 213
Ignition Module	9, 166	Oil Pump Seal Harness	61
Ignition Stator Assembly	24, 25, 27–29	O-Ring Cylinder Kit Trim	240
Ignition Stator Kit	25–27	O-Ring Cylinder Trim Kit	240
Impeller	95, 97–99, 249, 250, 252	O-Ring Kit Trim Cylinder	240
Impeller Housing Cover	182	O-Ring Trim Cylinder Kit	240
Impeller Kit	99, 182	Overhaul Gasket Set	213–217
Impeller Pump Kit	96, 100, 183, 184	Overhaul Kit Repair	239
Impeller Repair Kit	99, 101, 184, 185	Overhaul Kit Trim Cylinder	239, 240
Impeller Water Pump	95–99	Overhaul Repair Kit	239
Injector Fuel Harness	60	Overhaul Set Gasket	213–217
Injector Harness Fuel	60		
Inlet Needle Assembly	82, 83		

P

P/T Pump Motor Armature	238
Pick Up Tube	212
Pinion Gear	235
Pin Kit Rear Anchor	242
Points	2, 149, 150
Powerhead Gasket Set	122, 124, 127
Power Steering Cooler	205
Power Steering Oil Cooler	205
Power Trim Hose	244, 245
Power Trim Kit Relay	47
Power Trim Relay	46, 47, 168
Power Trim Relay Kit	47
Power Trim Sender	239
Power Trim Solenoid	45, 46, 167
Pump Assembly Trim	238
Pump Base Kit Water	184
Pump Circulating Hose	187, 188
Pump Fuel	178–180
Pump Fuel Diaphragm	64, 81
Pump Fuel Electric	179, 180
Pump Fuel Filter	181
Pump Gasket Water	217
Pump Hose Circulating	187, 188
Pump Impeller Kit	96, 100, 183, 184
Pump Impeller Water	95–99
Pump Kit, Boost	179
Pump Kit Base Water	184
Pump Kit Housing	184
Pump Kit Impeller	96, 100, 183, 184
Pump Kit Repair Water	94, 184
Pump Motor	238
Pump Oil	211, 212
Pump Oil Harness Seal	61
Pump Oil Seal Harness	61
Pump Repair Kit Water	94, 184
Pump Seal Fuel Harness	62
Pump Seal Harness Oil	61
Pump Seal Oil Harness	61
Pump Water	92–94, 103
Pump Water Impeller	95–99

R

Rear Anchor Pin Kit	242
Rear Cover Seawater Pump	182
Rectifier	23
Regulator Voltage	23
Relay	46–48, 168
Relay Assembly	46, 168
Relay Kit Power Trim	47
Relay Starter	45
Repair Kit	101–103
Repair Kit Carburetor	76–80, 171, 172
Repair Kit Gear	223, 224, 232, 233
Repair Kit Harness	168–170
Repair Kit Impeller	99, 101
Repair Kit Overhaul	239
Repair Kit Pump Water	94, 184
Repair Kit Transom Seal	221
Repair Kit Water Impeller	99–101
Repair Kit Water Pump	94, 184
Repair Overhaul Kit	239
Repair Pump Kit Water	94, 184
Repair Pump Water Kit	94, 184
Repair Seal Transom Kit	221
Reservoir	238
Reservoir Kit	238
Reservoir Kit Update	239
Reservoir Update Kit	239
Retainer Kit Drive	42, 43
Reverse Gear	235, 236
Rotor	10, 150, 151
Rotor Cap Kit	152, 153
Rotor Sender Kit	239

S

Seal Harness	62
Seal Harness Fuse	62
Seal Harness Injector Direct	62
Seal Kit	139–142, 229–231
Seal Kit Bearing	230
Seal Kit Propshaft	231
Seal Kit Transom Repair	221

Part Description Index

Seal MAP Harness Sensor	61	Thermostat Kit	186
Seal MAP Sensor Harness	61	Transom Repair Seal Kit	221
Seal Relay Harness	62	Trim Cylinder Kit O-Ring	240
Seal Temperature Sender Harness	61	Trim Cylinder Kit Overhaul	239, 240
Seawater Pump Rear Cover	182	Trim Cylinder O-Ring Kit	240
Sender Kit Rotor	239	Trim O-Ring Cylinder Kit	240
Sender Kit Temperature	117	Trim Pump Assembly	238
Sender Power Trim	239	Tube Pick Up	212
Sender Rotor Kit	239	Tune-Up Kit	149
Sensor Crank Harness	61	U	
Serpentine Belt	207, 208	Upper Housing	103–105
Serpentine Belt Kit	208	V	
Shift Cable	219, 220	V-Belt	207
Shift Cable Bellows	221	Voltage Regulator	23
Shift Cable Kit	219	W	
Shutter Water	206	Water Hose	198
Solenoid	45, 46, 167, 168, 239	Water Impeller Kit	99, 101, 184, 185
Solenoid Assembly	45, 167	Water Inlet Plug Kit	139
Solenoid Power Trim	46	Water Pump	92–94, 103
Solenoid Starter	45	Water Pump, Complete	94
Spark Plug Boot Kit	160	Water Pump Base Kit	184
Spark Plug Wire	157–160	Water Pump Gasket	217
Spark Plug Wire Set	158	Water Pump Housing	104
Starter Drive	41, 42	Water Pump Impeller	95–99
Starter Drive Assembly	41, 42	Water Pump Kit	93, 94
Starter Gear	41, 42	Water Pump Kit Base	184
Starter Motor	40, 41	Water Pump Kit Repair	94, 184
Starter Motor Assembly	38–41	Water Pump Repair Kit	94, 184, 252
Starter Motor Kit	38	Water Pump Upper Repair Kit	94
Starter Relay	41, 45	Water Repair Impeller Kit	99–101
Starter Solenoid	41, 45	Water Separating Fuel Filter	252
Stator	29	Water Shutter	206
Stator Assembly	24, 25, 27–29	Water Temperature Sender	116, 117
Stator Harness Seal	62		
Stator Ignition Assembly	24, 25, 27–29		
Stator Ignition Kit	25–27		
Stern Drive Installation Hardware	219		
Switch Box Assembly	7–9		
T			
Thermostat	117, 118		

QUICKSILVER[®]

Marine Parts & Accessories

CONSULT PART AVAILABILITY & PRICING | PLACE ORDERS
REGISTER PRODUCTS | PRINT INVOICES

<https://extranet.brunswick-marine.com>



www.mercurymarine.com